

DELIVERS WELL-BEING

• BOOSTING
CONFIDENCE
IN FLAWLESS
PROCEDURES



FORCEPS +



An Era Of **evolution**

Bonadent

HAS THE REPUTATION OF BEING THE ONLY IN PAKISTAN THAT MANUFACTURES ITS OWN TOOLS FOR THE PRODUCTION OF ITS INSTRUMENTS.

Bonadent is a privately owned company providing personalized services and the finest in Surgical Instruments for over 25 years. Established in 1999, Our Company manufactures a wide range of Surgical, Dental and Veterinary Instruments.

All Instruments and devices of our product range are manufactured by well-trained and experienced skilled workers with special craftsmanship and by use of most modern machines and equipment. On this occasion we only use materials which meet our high standards. The CEO of Bonadent Manufacturing co, Mr. Muhammad Ibrahim brings with him a lifetime of knowledge about the world of surgical instruments.

This insight allows us to understand the needs of our customers in a way most other instrument companies are unable to do.

After becoming a competent oem service provider, cardiac has decided to introduce itself as the original source of high quality instrumentation to directly interact with some of the well-known brands around the world.

Dissecting Forceps

Anatomische Pinzetten
Pinzas de disección
Pinces à dissection
Pinze per dissezione



1/2

B03-100-10
to

B03-100-23

Standardmodell
standard pattern
modelo estándar
modèle standard
modello standard

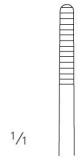

1/1

B03-100-10
10,5 cm / 4 1/8"



B03-100-11
11,5 cm / 4 5/8"



B03-100-13
13 cm / 5 1/8"



B03-100-14
14,5 cm / 5 7/8"



B03-100-16
16 cm / 6 3/8"



1/1

B03-100-18
18 cm / 7 1/8"



B03-100-20
20 cm / 7 7/8"



B03-100-23
23 cm / 9"



B03-100-25
25 cm / 9 7/8"



B03-100-30
30,5 cm / 12"



1/2

B03-101-12
to

B03-101-30

mittelbreit
medium width
de anchura medio
demi-large
di media larghezza

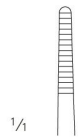

1/1

B03-101-12
12 cm / 4 5/8"



B03-101-13
13 cm / 5 1/8"



B03-101-14
14,5 cm / 5 7/8"



B03-101-16
16 cm / 6 3/8"



B03-101-18
18 cm / 7 1/8"



1/1

B03-101-20
20 cm / 7 7/8"



B03-101-23
23 cm / 9"



B03-101-25
25 cm / 9 7/8"



B03-101-30
30 cm / 11 3/8"



Dissecting Forceps

Anatomische Pinzetten
Pinzas de disección
Pincas à dissection
Pinze per dissezione

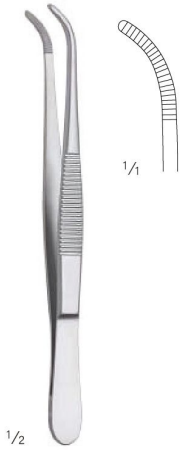

B03-102-13
13 cm / 5 1/8"



B03-103-14
14,5 cm / 5 9/16"

extra breit
extra wide
extra ancho
extra large
extra largo



B03-104-13
B03-104-14



B03-104-13
13 cm / 5 1/8"



B03-104-14
14,5 cm / 5 9/16"



Stille
B03-105-15
15 cm / 5 7/8"

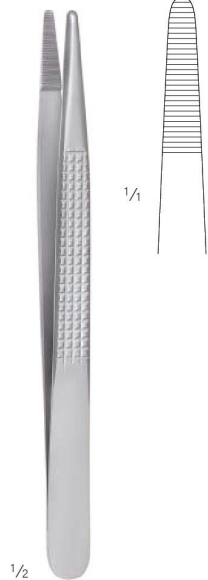
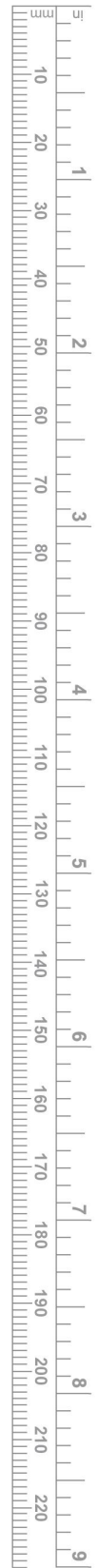

Bonney
B03-106-17
17 cm / 6 5/8"



B03-107-18
18,5 cm / 7 2/8"



Brophy
B03-108-20
20 cm / 7 7/8"



B03-109-20
20 cm / 7 7/8"

Dissecting Forceps
 Anatomische Pinzetten
 Pinzas de disección
 Pinces à dissection
 Pinze per dissezione

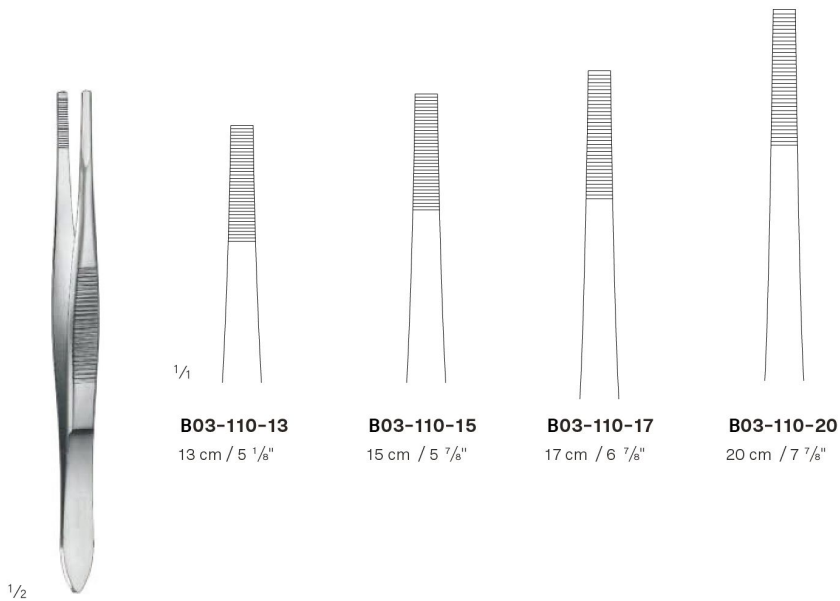

B03-110-13
 13 cm / 5 1/8"

B03-110-15
 15 cm / 5 7/8"

B03-110-17
 17 cm / 6 7/8"

B03-110-20
 20 cm / 7 7/8"

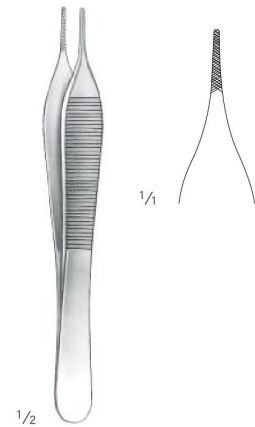

Mini-Adson
B03-111-12
 12 cm / 4 6/8"

Schweden-Modell
B03-110-13
 to
B03-110-20

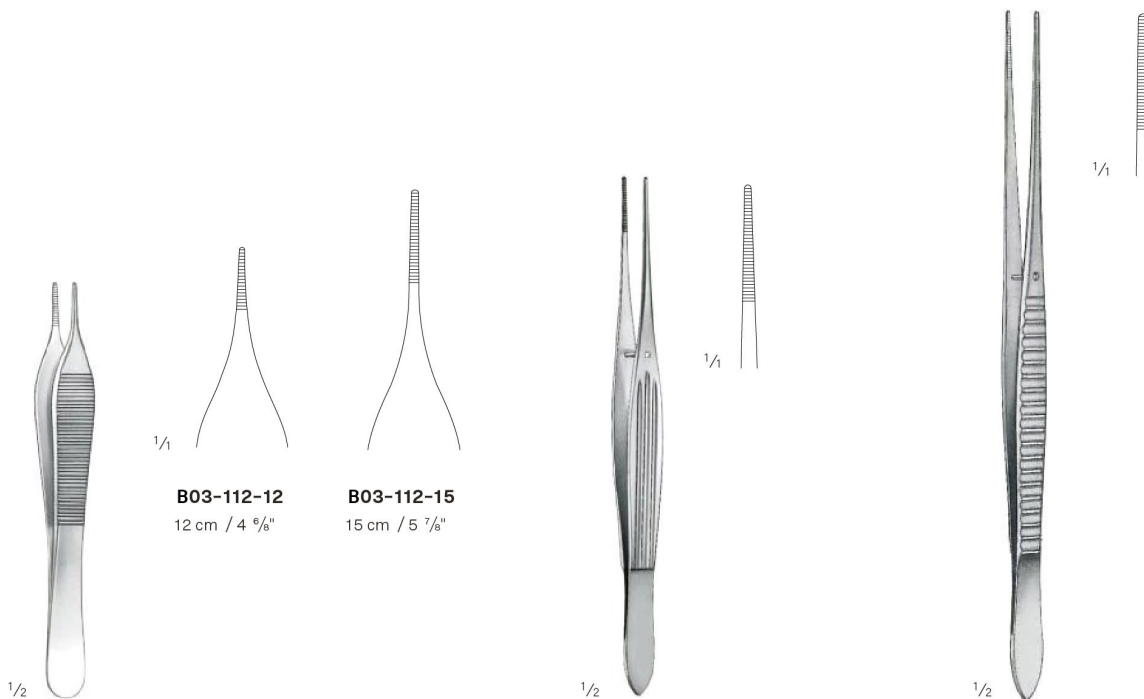

B03-112-12
 12 cm / 4 6/8"

B03-112-15
 15 cm / 5 7/8"

McIndoe
B03-113-15
 15 cm / 5 7/8"

Waugh
B03-114-20
 20 cm / 7 7/8"

Adson
B03-112-12
B03-112-15

Dissecting Forceps
 Anatomische Pinzetten
 Pinzas de disección
 Pincès à dissection
 Pinze per dissezione

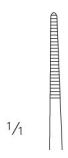

B03-115-12
 12,5 cm / 4 7/8"



B03-115-15
 15 cm / 5 7/8"

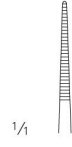

B03-116-15
 0,6 mm



B03-117-15
 0,8 mm



B03-118-15
 1,0 mm

Semken
B03-115-12
B03-115-15

B03-116-15
to
B03-118-18
 15,5 cm / 6 1/8"

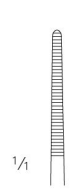

Taylor
B03-119-17
 17 cm / 6 5/8"



Taylor
B03-120-17
 17,5 cm / 6 7/8"
 mit Schaberende
 with dissector end
 con rascador
 à rugine
 con estremita a forma di raschino

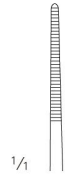

Taylor
B03-121-18
 18,5 cm / 7 2/8"
 mit Schaberende
 with dissector end
 con rascador
 à rugine
 con estremita a forma di raschino

Dissecting Forceps
 Anatomische Pinzetten
 Pinzas de disección
 Pincers à dissection
 Pinze per dissezione

Atrauma



B03-122-17
 17,5 cm / 6 7/8"



Gerald
B03-123-17
B03-124-17

B03-123-17
 17,5 cm / 6 7/8"

B03-124-17
 17 cm / 6 5/8"

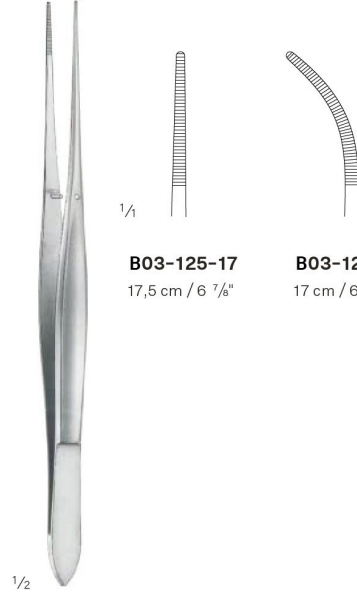

Cushing
B03-125-17
B03-126-17

B03-125-17
 17,5 cm / 6 7/8"

B03-126-17
 17 cm / 6 5/8"



Potts-Smith
B03-127-18
 to
B03-127-30

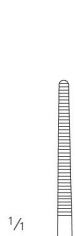

B03-127-18
 18 cm / 7 1/8"



B03-127-21
 21 cm / 8 2/8"



B03-127-25
 25 cm / 9 7/8"



B03-127-30
 30 cm / 11 5/8"

Tissue Forceps, Dissecting Forceps

Chirurgische Pinzetten, Anatomische Pinzetten
 Pinzas de disección con diente, Pinzas de disección
 Pincers à dissection à griffes, Pincers à dissection
 Pinze per dissezione con denti, Pinze per dissezione



TC GOLD

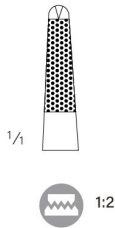

1/2

Bonney
B03-128-17
 17,5 cm / 6 7/8"
 Normalprofil
 standard profile
 perfil estándar
 profil normal
 profilo normale

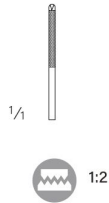

1/2

Gerald
B03-129-17
 17,5 cm / 6 7/8"
 Normalprofil
 standard profile
 perfil estándar
 profil normal
 profilo normale

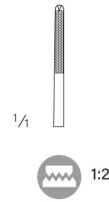

1/2

Gillies
B03-130-15
 15,5 cm / 6 1/8"
 Miniprofil
 mini profile
 perfil mini
 profil mini
 mini-profilo



1/2

McIndoe
B03-131-15
 15 cm / 5 7/8"
 Miniprofil
 mini profile
 perfil mini
 profil mini
 mini-profilo

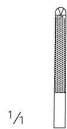

1/2

Semken
C03-132-15
 to
C03-134-17

B03-132-15
 15,5 cm / 6 1/8"
 Normalprofil
 normal profile
 perfil normal
 profil normal
 profilo normale



B03-133-17
 17,5 cm / 6 7/8"
 Normalprofil
 normal profile
 perfil normal
 profil normal
 profilo normale



B03-134-15
 15,5 cm / 6 1/8"
 Miniprofil
 mini profile
 perfil mini
 profil mini
 mini-profilo



B03-135-17
 17,5 cm / 6 7/8"
 Miniprofil
 mini profile
 perfil mini
 profil mini
 mini-profilo



Tissue Forceps, Dissecting Forceps

Chirurgische Pinzetten, Anatomische Pinzetten
 Pinzas de disección con diente, Pinzas de disección
 Pincas à dissection à griffes, Pincas à dissection
 Pinze per dissezione con denti, Pinze per dissezione



TC GOLD



Adson-Brown

B03-136-12

12 cm / 4 5/8"

Normalprofil
 normal profile
 perfil normal
 profil normal
 profilo normale



Adson

B03-137-12

B03-137-15

B03-137-12

12 cm / 4 5/8"

Miniprofil
 mini profile
 perfil mini
 profil mini
 mini-profilo



B03-137-15

15 cm / 5 7/8"

Miniprofil
 mini profile
 perfil mini
 profil mini
 mini-profilo



Adson

B03-138-12

B03-142-15

B03-138-12

12 cm / 4 5/8"

Normalprofil
 normal profile
 perfil normal
 profil normal
 profilo normale

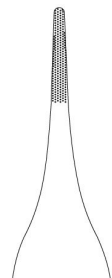

B03-139-15

15 cm / 5 7/8"

Normalprofil
 normal profile
 perfil normal
 profil normal
 profilo normale



B03-141-12

12 cm / 4 5/8"

Normalprofil
 normal profile
 perfil normal
 profil normal
 profilo normale



B03-142-15

15 cm / 5 7/8"

Normalprofil
 normal profile
 perfil normal
 profil normal
 profilo normale



Dissecting Forceps

Anatomische Pinzetten
Pinzas de disección
Pinces à dissection
Pinze per dissezione



TC GOLD

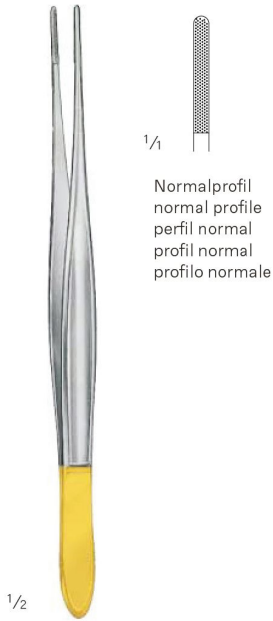

Cushing
B03-143-17
17,5 cm / 6 7/8"



Cushing
B03-144-17
17 cm / 6 5/8"

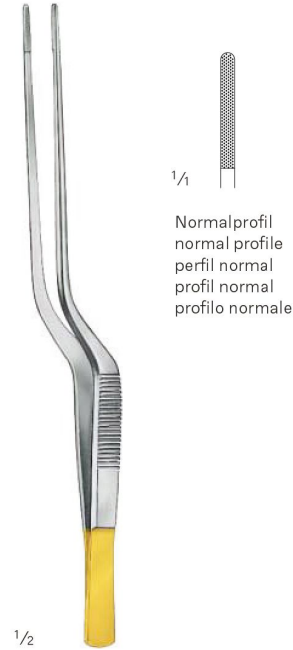

Cushing-Taylor
B03-145-18
18,5 cm / 7 3/8"

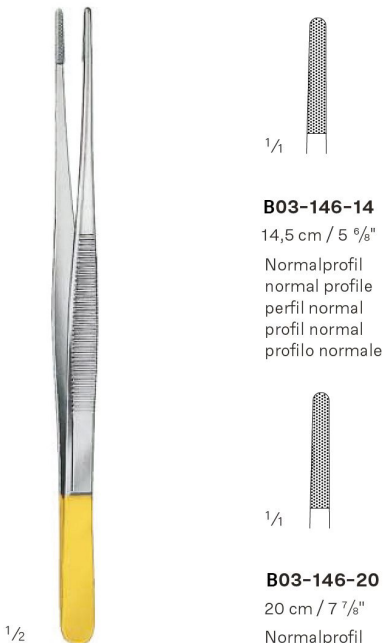

Potts-Smith
B03-146-14
to
B03-146-25

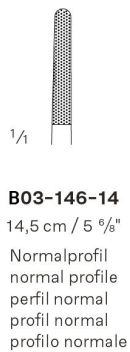

Tissue Forceps, Dissecting Forceps

Chirurgische Pinzetten, Anatomische Pinzetten
 Pinzas de disección con diente, Pinzas de disección
 Pincers à dissection à griffes, Pincers à dissection
 Pinze per dissezione con denti, Pinze per dissezione



TC GOLD



1/2

Oehler
B03-147-14
 to
B03-147-25



1/4

B03-147-14
 14,5 cm / 5 9/16"
 Normalprofil
 normal profile
 perfil normal
 profil normal
 profilo normale

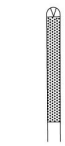

1/4

B03-147-16
 16 cm / 6 2/8"
 Normalprofil
 normal profile
 perfil normal
 profil normal
 profilo normale

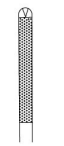

1/4

B03-147-18
 18 cm / 7 1/8"
 Normalprofil
 normal profile
 perfil normal
 profil normal
 profilo normale

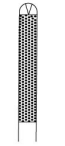

1/4

B03-147-20
 20 cm / 7 7/8"
 Normalprofil
 normal profile
 perfil normal
 profil normal
 profilo normale

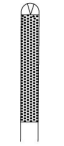

1/4

B03-147-25
 25 cm / 9 7/8"
 Normalprofil
 normal profile
 perfil normal
 profil normal
 profilo normale



1/2

Wangenstein
C03-148-15
C03-148-23



1/4

B03-148-15
 15 cm / 5 7/8"
 Normalprofil
 normal profile
 perfil normal
 profil normal
 profilo normale



1/4

B03-148-23
 23 cm / 9"
 Normalprofil
 normal profile
 perfil normal
 profil normal
 profilo normale



Dissecting Forceps

Anatomische Pinzetten
Pinzas de disección
Pincas à dissection
Pinze per dissezione

TC GOLD
Atrauma



1/2

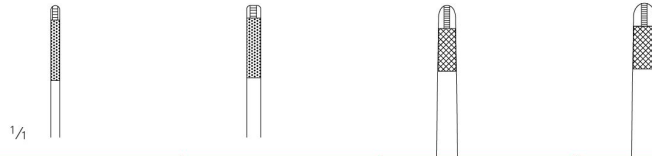

	Miniprofil mini profile perfil mini profil mini mini-profilo	Miniprofil mini profile perfil mini profil mini mini-profilo	Normalprofil normal profile perfil normal profil normal profilo normale	Normalprofil normal profile perfil normal profil normal profilo normale
	1,5 mm	2,0 mm	2,7 mm	3,5 mm
16 cm / 6 2/8"	B03-149-16	B03-150-16	B03-151-16	B03-152-16
20 cm / 7 7/8"	B03-149-20	B03-150-20	B03-151-20	B03-152-20
24,5 cm / 9 5/8"	B03-149-24	B03-150-24	B03-151-24	B03-152-24

DeBakey

B03-149-16
to
B03-152-24



1/2

Jaboma

B03-153-18
18 cm / 7 1/8"



1/2

Jaboma

B03-154-18
18 cm / 7 1/8"



1/2

Jaboma

B03-155-18
18 cm / 7 1/8"



Dissecting Forceps, Atraumatic Dissecting Forceps
 Anatomische Pinzetten, Atraumatische Pinzetten
 Pinzas de disección, Pinzas de disección atraumática
 Pincès à dissection, Pincès atraumatiques à dissection
 Pinze per dissezione, Pinze atraumatiche



1/2

DeBakey
B03-156-16

Atrauma

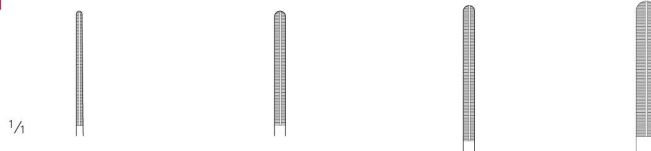

	1,0 mm	1,5 mm	1,8 mm	2,8 mm
16 cm / 6 2/8"	B03-156-16	B03-157-16	B03-158-16	B03-159-16
20,5 cm / 8 1/8"	B03-156-20	B03-157-20	B03-158-20	B03-159-20
24,5 cm / 9 5/8"	B03-156-24	B03-157-24	B03-158-24	B03-159-24



1/2

Gerald
B03-160-18
to
B03-165-20



	Atrauma		
	1,2 mm	1,0 x 0,5 mm	1,0 mm
18 cm / 7 1/8"	B03-160-18	B03-161-18	B03-162-18
18 cm / 7 1/8"	B03-163-18	B03-164-18	B03-165-18
20 cm / 7 7/8"	B03-160-20	B03-161-20	B03-162-20
20 cm / 7 7/8"	B03-163-20	B03-164-20	B03-165-20



Tissue Forceps

Chirurgische Pinzetten
 Pinzas de disección con diente
 Pinces à dissection à griffes
 Pinze per dissezione con denti



1/2

B03-166-10
 to
B03-166-30
 Standardmodell
 standard pattern
 modelo estándar
 modèle standard
 modello standard



1/2

B03-167-12
 to
B03-167-25













1/1		B03-166-10 10,5 cm / 4 1/8"		B03-166-12 12 cm / 4 9/16"		B03-166-13 13 cm / 5 1/8"		B03-166-14 14,5 cm / 5 9/16"		B03-166-16 16 cm / 6 2/8"
		1:2		1:2		1:2		1:2		1:2
1/1		B03-166-18 18 cm / 7 1/8"		B03-166-20 20,5 cm / 8 1/8"		B03-166-23 23 cm / 9"		B03-166-25 25 cm / 9 7/8"		B03-166-30 30,5 cm / 12"
		1:2		1:2		1:2		1:2		1:2
1/1		B03-167-12 12 cm / 4 9/16"		B03-167-13 13 cm / 5 1/8"		B03-167-14 14,5 cm / 5 9/16"		B03-167-16 16 cm / 6 2/8"		
		2:3		2:3		2:3		2:3		
1/1		B03-167-17 17 cm / 6 9/16"		B03-167-18 18 cm / 7 1/8"		B03-167-20 20,5 cm / 8 1/8"		B03-167-25 25 cm / 9 7/8"		
		2:3		2:3		2:3		2:3		



















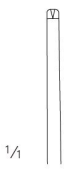

Tissue Forceps

Chirurgische Pinzetten
 Pinzas de disección con diente
 Pinces à dissection à griffes
 Pinze per dissezione con denti



						
	B03-168-14 14,5 cm / 5 9/16"	B03-168-16 16 cm / 6 2/8"	B03-168-20 20 cm / 7 7/8"		B03-169-14 14,5 cm / 5 9/16"	B03-169-16 16 cm / 6 2/8"
	 3:4	 3:4	 3:4		 4:5	 4:5
B03-168-14 to B03-168-20				B03-169-14 to B03-169-16		

				
	B03-170-13 13 cm / 5 1/8"	B03-170-14 14,5 cm / 5 9/16"	B03-170-16 16 cm / 6 2/8"	B03-170-18 18 cm / 7 1/8"
	 1:2	 1:2	 1:2	 1:2
				
	B03-170-20 20,5 cm / 8 1/16"	B03-170-23 23 cm / 9"	B03-170-25 25 cm / 9 7/8"	B03-170-30 30 cm / 11 9/16"
	 1:2	 1:2	 1:2	 1:2
B03-170-13 to B03-170-30 mittelbreit medium medio moyen medio				

Tissue Forceps

Chirurgische Pinzetten
 Pinzas de disección con diente
 Pinces à dissection à griffes
 Pinze per dissezione con denti

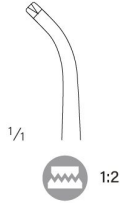

B03-171-14
 14,5 cm / 5 9/16"

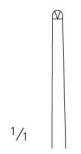

B03-172-13
 13 cm / 5 1/8"

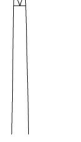

B03-172-14
 14,5 cm / 5 9/16"

B03-172-13
B03-172-14

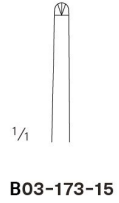

B03-173-15

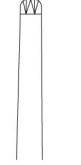

B03-174-15

Stille

B03-173-15
B03-174-15
 15 cm / 5 7/8"

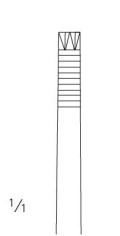

B03-175-15
 15,5 cm / 6 1/8"

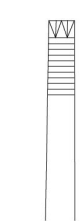

B03-176-20
 20,5 cm / 8 1/8"



B03-177-15
 15,5 cm / 6 1/8"

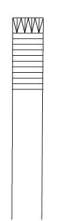

B03-178-20
 20 cm / 7 7/8"

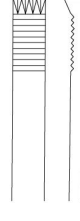

B03-179-25
 25 cm / 9 7/8"

Adlerkreutz
B03-175-15
 to
B03-179-25

Tissue Forceps

Chirurgische Pinzetten
Pinzas de disección con diente
Pincas à dissection à griffes
Pinze per dissezione con denti



B03-180-12
12 cm / 4 5/8"



1:2

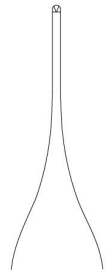

B03-180-15
15 cm / 5 7/8"



1:2



Gillies
B03-181-15
15,5 cm / 6 1/8"

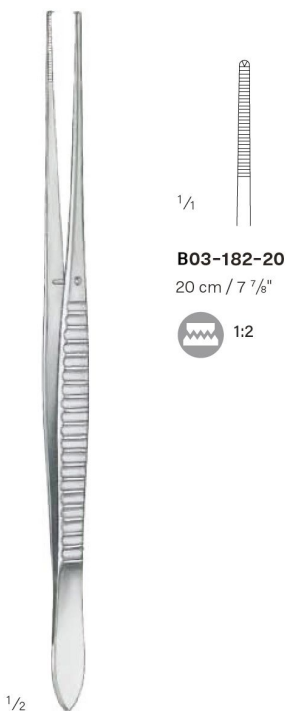

B03-182-20
20 cm / 7 7/8"



1:2

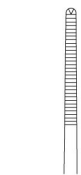

B03-182-25
25 cm / 9 7/8"



1:2

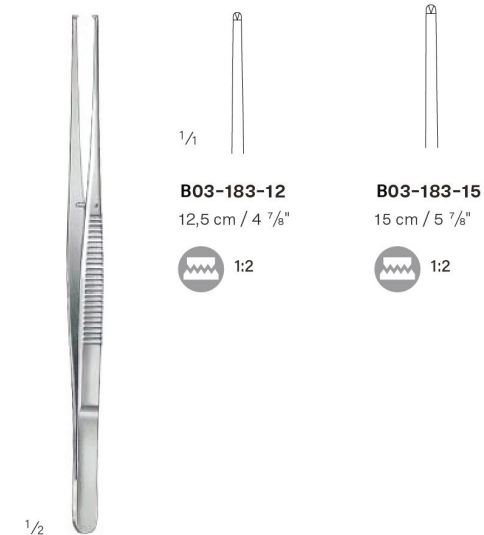

B03-183-12
12,5 cm / 4 7/8"



1:2

B03-183-15
15 cm / 5 7/8"



1:2

Waugh
B03-182-20
B03-182-25

Semken
B03-183-12
B03-183-15



Tissue Forceps, Dissecting Forceps

Chirurgische Pinzetten, Anatomische Pinzetten
 Pinzas de disección con diente, Pinzas de disección
 Pincès à dissection à griffes, Pincès à dissection
 Pinze per dissezione con denti, Pinze per dissezione



Brophy
B03-184-20
 20 cm / 7 7/8"

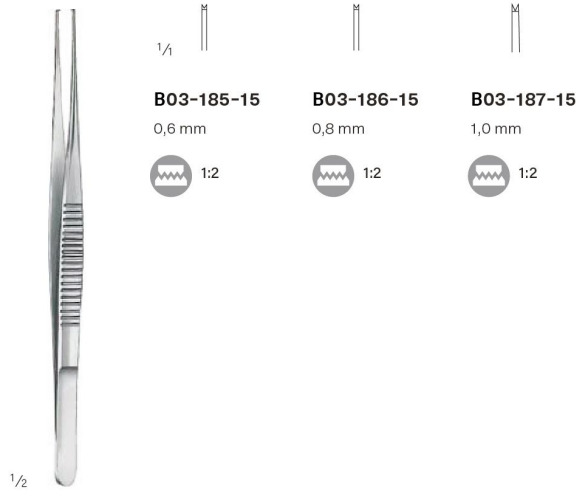

B03-185-15
 to
B03-187-15
 15,5 cm / 6 1/8"



Taylor
B03-188-17
 17,5 cm / 6 7/8"



Taylor
B03-189-17
 17 cm / 6 5/8"
 mit Schaberende
 with dissector end
 con rascador
 à rugine
 con estremita a forma di raschino



Taylor
B03-190-18
 18,5 cm / 7 2/8"
 mit Schaberende
 with dissector end
 con rascador
 à rugine
 con estremita a forma di raschino



Tissue Forceps

Chirurgische Pinzetten
Pinzas de disección con diente
Pinces à dissection à griffes
Pinze per dissezione con denti

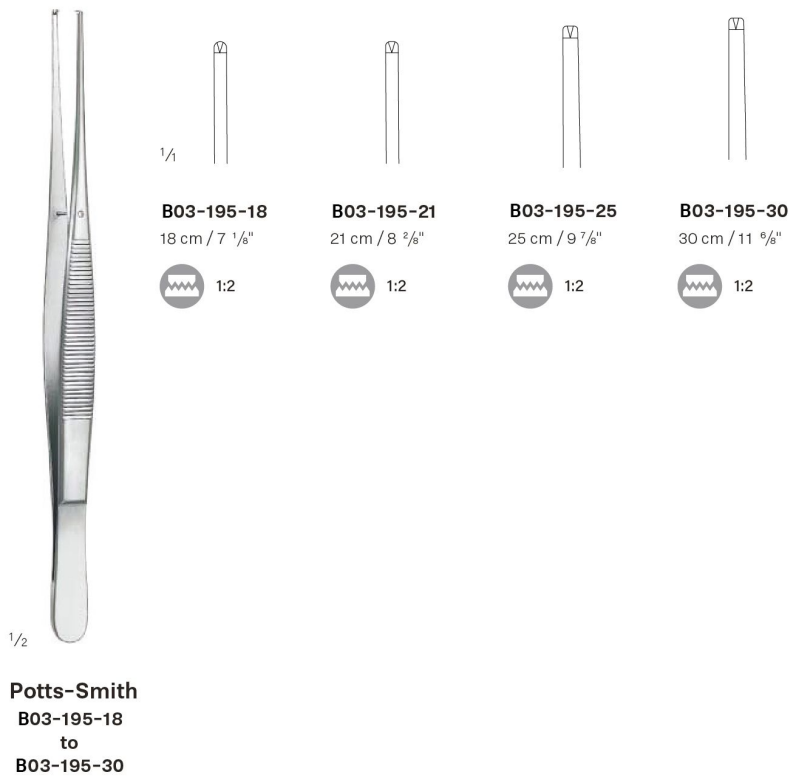
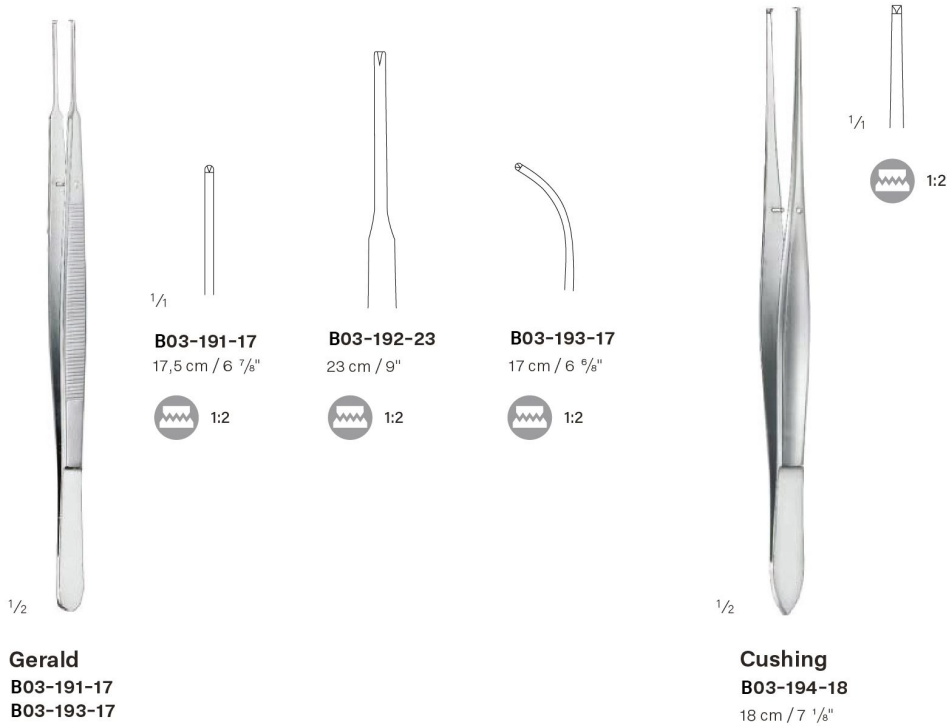

Dissecting Forceps, Tissue Forceps

Anatomische Pinzetten, Chirurgische Pinzetten
 Pinzas de disección, Pinzas de disección con diente
 Pincès à dissection, Pincès à dissection à griffes

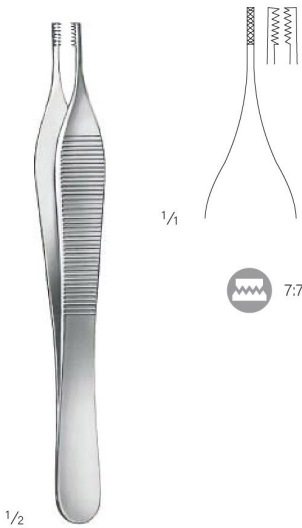
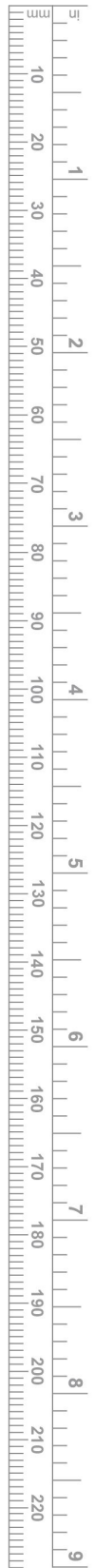

Adson-Brown
B03-196-12
 12 cm / 4 5/8"

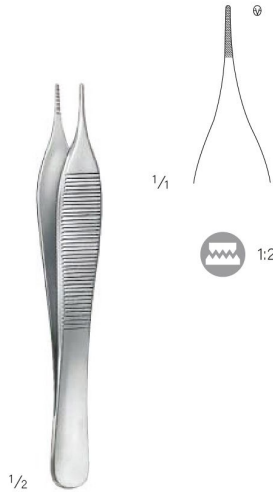

Mini-Adson
B03-197-12
 12 cm / 4 5/8"

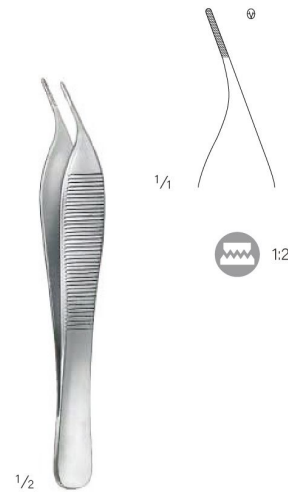

Mini-Adson
B03-198-12
 12 cm / 4 5/8"

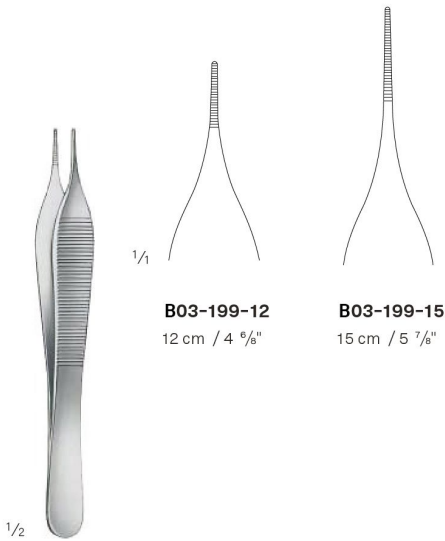

Mikro-Adson
B03-199-12
B03-199-15

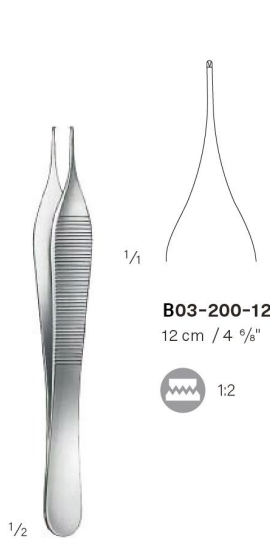

Mikro-Adson
B03-200-12
B03-200-15

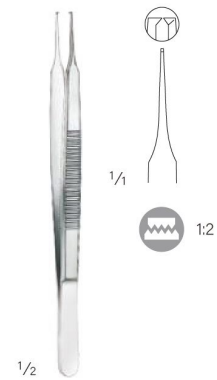

B03-201-10
 10,5 cm / 4 1/8"
 sehr feine Zähne
 very fine teeth
 dientes muy finos
 dents très fines
 denti molto fini

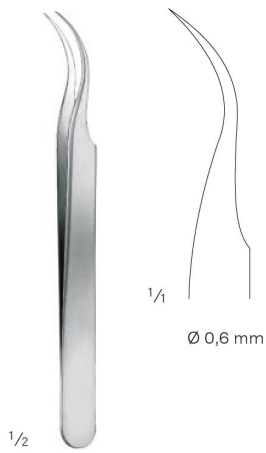

B03-202-12
 12 cm / 4 ³/₈"
 Fig. 7

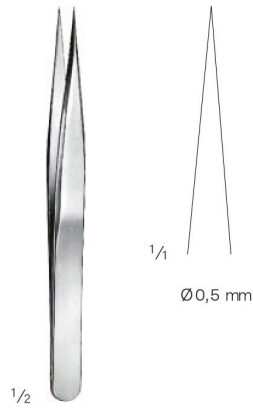

B03-203-12
 12 cm / 4 ³/₈"
 Fig. 3

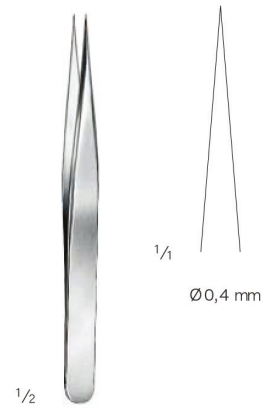

B03-204-11
 11 cm / 4 ³/₈"
 Fig. 3 C

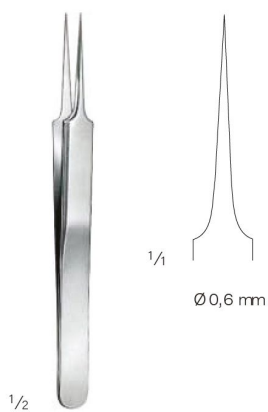

B03-205-11
 11 cm / 4 ³/₈"
 Fig. 5

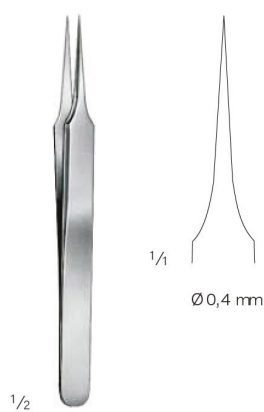

B03-206-11
 11 cm / 4 ³/₈"
 Fig. 4

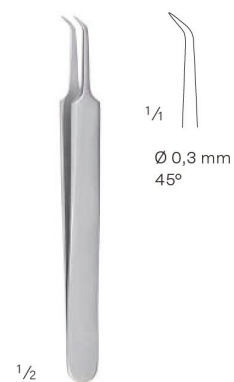

B03-207-11
 11 cm / 4 ³/₈"

Tissue Forceps

Chirurgische Pinzetten
Pinzas de disección con diente
Pinces à dissection à griffes
Pinze per dissezione con denti

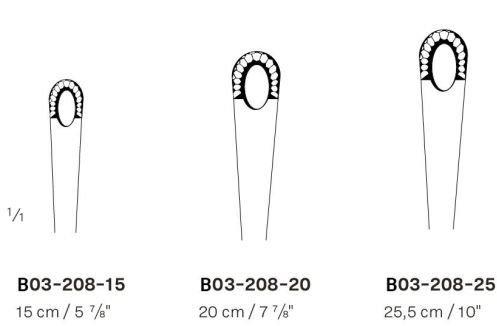

B03-208-15
15 cm / 5 7/8"

B03-208-20
20 cm / 7 7/8"

B03-208-25
25,5 cm / 10"

1/2

Russ. Modell

B03-208-15
to
B03-208-25

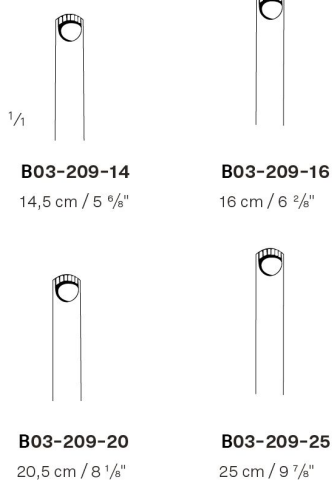

B03-209-14
14,5 cm / 5 9/16"

B03-209-16
16 cm / 6 2/8"

B03-209-20
20,5 cm / 8 1/8"

B03-209-25
25 cm / 9 7/8"

1/2

Durante
B03-209-14
to
B03-209-25

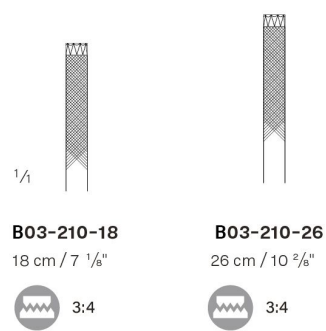

B03-210-18
18 cm / 7 1/8"

B03-210-26
26 cm / 10 2/8"



1/2

Stille-Barraya
B03-210-18
B03-210-26



Tissue Forceps, Dissecting Forceps

Chirurgische Pinzetten, Anatomische Pinzetten
Pinzas de disección con diente, Pinzas de disección
Pincas à dissection à griffes, Pincas à dissection
Pinze per dissezione con denti, Pinze per dissezione

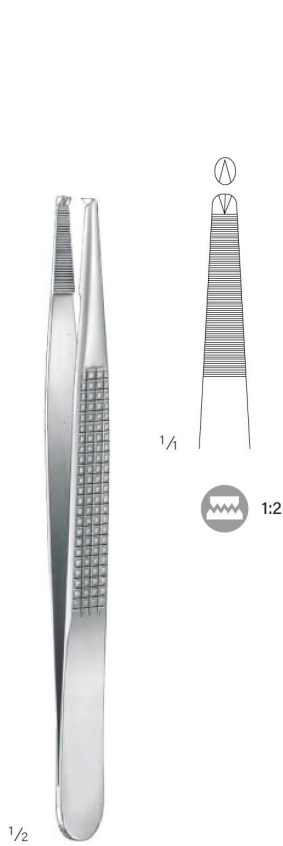

Bonney
B03-211-17
17,5 cm / 6 7/8"



Mayo
B03-212-23
23 cm / 9"



Singley-Tuttle
B03-213-18
18 cm / 7 1/8"



Singley-Tuttle
B03-214-23
23 cm / 9"

Tissue Forceps

Chirurgische Pinzetten
Pinzas de disección con diente
Pincas à dissection à griffes
Pinze per dissezione con denti



Nelson
B03-215-23
23 cm / 9"



Resano
B03-216-23
23 cm / 9"

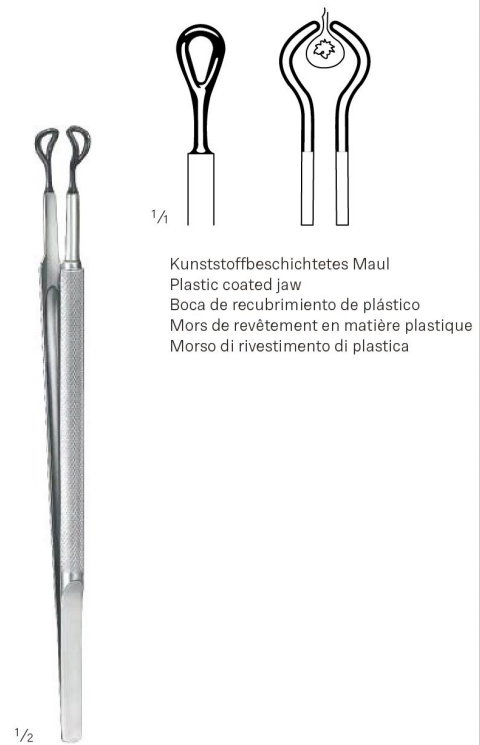

Hepp-Scheidel
B03-217-18
18 cm / 7 1/8"
Tubenfasspinzette
Tubal forceps
Pinza para tubos
Pince pour saisir les trompes
pinza oer afferare tubi

Kunststoffbeschichtetes Maul
Plastic coated jaw
Boca de recubrimiento de plástico
Mors de revêtement en matière plastique
Morso di rivestimento di plastica



Dissecting Forceps, Tissue Forceps
 Anatomische Pinzetten, Chirurgische Pinzetten
 Pinzas de disección, Pinzas de disección con diente
 Pincas à dissection, Pincas à dissection à griffes



1/2

B03-218-10
 to
B03-223-09
 fein
 delicate
 fino
 fin
 fino



1/1

B03-218-10
 10 cm / 3 7/8"



B03-219-10
 10 cm / 3 7/8"



B03-220-09
 9,5 cm / 3 5/8"



B03-221-10
 10 cm / 3 7/8"



1:2



B03-222-10
 10 cm / 3 7/8"



1:2



B03-223-09
 9,5 cm / 3 5/8"



1:2

Short Micro Forceps
 Kurze Mikropinzetten
 Micro Pinzas, corto
 Micro-Pinces, court
 Micro-Pinze, corto



1/2
B03-224-01
 to
B03-225-03
 11 cm / 4 3/8"



1/2
B03-224-07
 to
B03-225-06
 11 cm / 4 3/8"

1/4			
Ø	0.15 mm	0.20 mm	0.30 mm
St	B03-224-01	B03-224-02	B03-224-03
1/4			
Ø	0.50 mm	1.2 mm	
St	B03-225-01	B03-225-02	B03-225-03
1/4			
	VD	VD	VD
Ø	0.10 mm	0.20 mm	0.30 mm
gewinkelt/angled/ acodada/angulée/ angolata	10°	10°	10°
St	B03-224-04	B03-224-05	B03-224-06
1/4			
Ø	0.15 mm	0.20 mm	0.30 mm
St	B03-224-07	B03-224-08	B03-224-09
1/4			
Ø	0.50 mm	1.2 mm	
St	B03-225-04	B03-225-05	B03-225-06
1/4			
	VD	VD	VD
Ø	0.10 mm	0.20 mm	0.30 mm
gewinkelt/angled/ acodada/angulée/ angolata	10°	10°	10°
St	B03-224-10	B03-224-11	B03-224-12



Micro Forceps, Micro dilating forceps
 Mikropinzetten, Gefäß-Dilatationspinzetten
 Micro Pinzas, Micro pinza de dilatación
 Micro-Pinces, Micro pince à dilater
 Micro-Pinze, Micro pinze per dilatazione



1/2

Jeweler mod.
B03-226-11
 to
B03-231-13

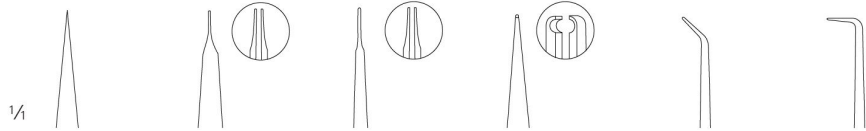

			VD	VD	Pierse	45°	90°
11 cm / 4 3/8"	Ø	0.30 mm	0.20 mm	0.30 mm	0.30 mm	0.30 mm	0.30 mm
	St	B03-226-11	B03-227-11	B03-228-11	B03-229-11	B03-230-11	B03-231-11
13,5 cm / 5 3/8"	St	B03-226-13	B03-227-13	B03-228-13	B03-229-13	B03-230-13	B03-231-13



1/2

B03-232-15
 to
B03-237-18



				45°		VD	Pierse
15 cm / 5 7/8"	Ø	0.30 mm	0.30 mm	0.30 mm	1.0 x 0.5 mm	0.30 mm	0.30 mm
	St	B03-232-15	B03-233-15	B03-234-15	B03-235-15	B03-236-15	B03-237-15
18 cm / 7 1/8"	St	B03-232-18	B03-233-18	B03-234-18	B03-235-18	B03-236-18	B03-237-18

Micro Forceps, Micro dilating forceps
 Mikropinzetten, Gefäß-Dilatationspinzetten
 Micro Pinzas, Micro pinza de dilatación
 Micro-Pinces, Micro pince à dilater
 Micro-Pinze, Micro pinze per dilatazione



1/2

B03-238-15
to
B03-245-25



	Ø	0.40 mm	0.40 mm	0.70 mm	0.70 mm	0.80 mm	0.80 mm
15 cm / 5 7/8"	St	B03-238-15	B03-298-15	B03-240-15	B03-241-15		
15 cm / 5 7/8"	Ti	B03-242-15	B03-243-15			B03-244-15	B03-245-15
18 cm / 7 1/8"	St	B03-238-18	B03-298-18	B03-240-18	B03-241-18		
18 cm / 7 1/8"	Ti	B03-242-18	B03-243-18			B03-244-18	B03-245-18
21 cm / 8 2/8"	St			B03-240-21	B03-241-21		
21 cm / 8 2/8"	Ti					B03-244-21	B03-245-21
23 cm / 9"	St			B03-240-23	B03-241-23		
23 cm / 9"	Ti					B03-244-23	B03-245-23
25 cm / 9 7/8"	St			B03-240-25	B03-241-25		
25 cm / 9 7/8"	Ti					B03-244-25	B03-245-25



1/2

B03-246-15
to
B03-251-18



	Ø	0.30 mm	0.30 mm	45°	1.0 x 0.5 mm	VD	Pliers
15 cm / 5 7/8"	St	B03-246-15	B03-247-15	B03-248-15	B03-249-15	B03-250-15	B03-251-15
18 cm / 7 1/8"	St	B03-246-18	B03-247-18	B03-248-18	B03-249-18	B03-250-18	B03-251-18

Micro Forceps
 Mikropinzetten
 Micro Pinzas
 Micro-Pinces
 Micro-Pinze



1/2

B03-252-18
 to
B03-255-25



1/1



	Ø	0.40 mm	0.40 mm	0.70 mm	0.70 mm
18 cm / 7 1/8"	St	B03-252-18	B03-253-18	B03-254-18	B03-255-18
21 cm / 8 2/8"	St			B03-254-21	B03-255-21
23 cm / 9"	St			B03-254-23	B03-255-23
25 cm / 9 7/8"	St			B03-254-25	B03-255-25



1/2

B03-256-18
 to
B03-261-25



1/1

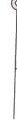

	Ø	1.0 x 0.5 mm	1.0 x 0.5 mm	1.0 x 0.5 mm	2.0 x 1.0 mm	2.0 x 1.0 mm	Atrauma
18 cm / 7 1/8"	St	B03-256-18	B03-257-18	B03-258-18	B03-259-18	B03-260-18	B03-261-18
21 cm / 8 2/8"	St	B03-256-21	B03-257-21	B03-258-21	B03-259-21	B03-260-21	B03-261-21
23 cm / 9"	St	B03-256-23	B03-257-23	B03-258-23	B03-259-23	B03-260-23	B03-261-23
25 cm / 9 7/8"	St	B03-256-25	B03-257-25	B03-258-25	B03-259-25	B03-260-25	B03-261-25

Micro Forceps
Mikropinzetten
Micro Pinzas
Micro-Pinces
Micro-Pinze



1/2

B03-262-15
to
B03-269-21



	Ø	1:2	1:2	1:2	1:2	1:2	1:2
15 cm / 5 7/8"	St	B03-262-15	B03-263-15	B03-264-15	B03-265-15		
15 cm / 5 7/8"	Ti	B03-266-15	B03-267-15			B03-268-15	B03-269-15
18 cm / 7 1/8"	St	B03-262-18	B03-263-18	B03-264-18	B03-265-18		
18 cm / 7 1/8"	Ti	B03-266-18	B03-267-18			B03-268-18	B03-269-18
21 cm / 8 2/8"	St			B03-264-21	B03-265-21		
21 cm / 8 2/8"	Ti					B03-268-21	B03-269-21
23 cm / 9"	St			B03-264-23	B03-265-23		



1/2

B03-266-15
to
B03-277-25



	Ø	1.0 x 0.5 mm	1.0 x 0.5 mm	1.0 x 0.5 mm	2.0 x 1.0 mm	2.0 x 1.0 mm	Atrauma
15 cm / 5 7/8"	St	B03-266-15	B03-267-15	B03-268-15	B03-269-15	B03-270-15	B03-271-15
15 cm / 5 7/8"	Ti	B03-272-15	B03-273-15	B03-274-15	B03-275-15	B03-276-15	B03-277-15
18 cm / 7 1/8"	St	B03-266-18	B03-267-18	B03-268-18	B03-269-18	B03-270-18	B03-271-18
18 cm / 7 1/8"	Ti	B03-272-18	B03-273-18	B03-274-18	B03-275-18	B03-276-18	B03-277-18
21 cm / 8 2/8"	St	B03-266-21	B03-267-21	B03-268-21	B03-269-21	B03-270-21	B03-271-21
21 cm / 8 2/8"	Ti	B03-272-21	B03-273-21	B03-274-21	B03-275-21	B03-276-21	B03-277-21
23 cm / 9"	St	B03-266-23	B03-267-23	B03-268-23	B03-269-23	B03-270-23	B03-271-23
23 cm / 9"	Ti	B03-272-23	B03-273-23	B03-274-23	B03-275-23	B03-276-23	B03-277-23
25 cm / 9 7/8"	St	B03-266-25	B03-267-25	B03-268-25	B03-269-25	B03-270-25	B03-271-25
25 cm / 9 7/8"	Ti	B03-272-25	B03-273-25	B03-274-25	B03-275-25	B03-276-25	B03-277-25



Splinter Forceps

Splitterpinzetten
Pinzas para espinas
Pincas à échardes
Pinze per scheggie

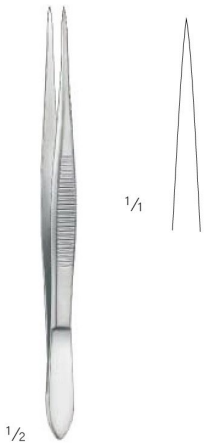

B03-278-12

12,5 cm / 4 7/8"
glattes Maul
smooth jaw
boca lisa
mors lisse
morso liscio

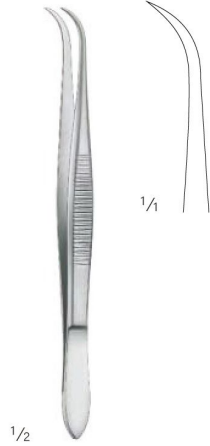

B03-279-12

12,5 cm / 4 7/8"
glattes Maul
smooth jaw
boca lisa
mors lisse
morso liscio



B03-280-09
9 cm / 3 4/8"



B03-280-10
10,5 cm / 4 1/8"



B03-280-12
12,5 cm / 4 7/8"



B03-281-09
9 cm / 3 4/8"

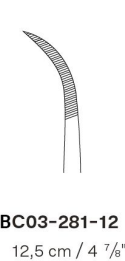

BC03-281-12
12,5 cm / 4 7/8"

B03-280-09
to
B03-280-12
gerieftes Maul
serrated jaw
boca estriada
mors strié
morso striato

B03-281-09
B03-281-12
gerieftes Maul
serrated jaw
boca estriada
mors strié
morso striato

Splinter Forceps

Splinterpinzetten
Pinzas para espinas
Pinces à échardes
Pinze per scheggie



B03-282-15

15,5 cm / 6 1/8"

Mikro-Knüpfpinzette, glattes Maul
Micro Tying Forceps, smooth jaw
Micro Pinza para anudar, boca lisa
Micro-Pince à poser des ligatures, mors lisse
Micro-Pinza per legature, morso liscio



1/1

B03-283-15
0,5 mm



B03-284-15
0,8 mm



1/1

0,3 mm



1/1

0,8 mm

Austin

B03-286-14

14 cm / 5 4/8"



1/1

B03-287-07
7,5 cm / 3"

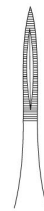

B03-287-09
9 cm / 3 4/8"

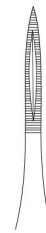

B03-287-11
11,5 cm / 4 4/8"

Feilchenfeld

B03-287-07

to

B03-287-11

Splinter Forceps, Microscopic Forceps
 Splitterpinzetten, Mikroskopierpinzetten
 Pinzas para espinas, Pinzas para microscopías
 Pincès à échardes, Pincès à microscopies
 Pinze per scheggie, Pinze per microscopia

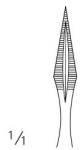

B03-288-10
 10,5 cm / 4 1/8"



B03-289-10
 10,5 cm / 4 1/8"



B03-290-10
 10 cm / 3 7/8"



B03-291-10
 10 cm / 3 7/8"

Hunter

B03-288-10
B03-289-10

B03-290-10
 10 cm / 3 7/8"

B03-291-10
 10 cm / 3 7/8"



B03-292-10
 10 cm / 3 7/8"

Mikroskopierpinzette, superleicht, stumpf
 Microscopic Forceps, super light, blunt
 Pinza para microscopia, super ligero, roma
 Pince à microscopie, très légère, mousse
 Pinza per microscopia, molto leggera, smussa

B03-293-10
 10 cm / 3 7/8"

Mikroskopierpinzette, superleicht, spitz
 Microscopic Forceps, super light, sharp
 Pinza para microscopia, super ligero, puntiaguda
 Pince à microscopie, très légère, pointue
 Pinza per microscopia, molto leggera, appuntata

Shaaf
B03-294-09
 9,5 cm / 3 6/8"

Cilia Forceps

Cilienpinzetten
Pinzas depilatorias
Pinces à épiler les cils
Pinze depilatoria

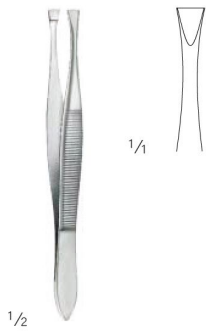

Littauer
B03-295-08

8,5 cm / 3 3/8"
glattes Maul
smooth jaw
boca lisa
mors lisse
morso liscio

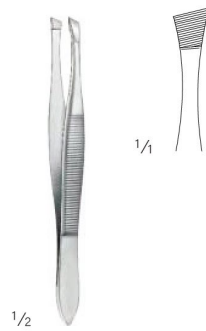

B03-296-09

9 cm / 3 4/8"

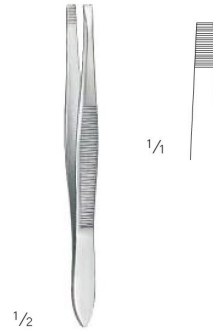

Douglas
B03-297-09

9 cm / 3 4/8"

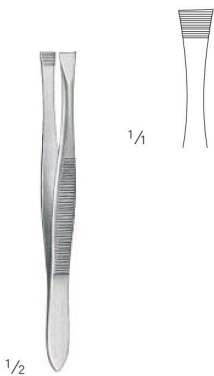

Douglas
B03-298-09

9 cm / 3 4/8"

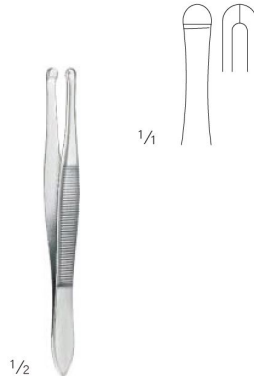

Beer
B03-299-09

9 cm / 3 4/8"
glattes Maul
smooth jaw
boca lisa
mors lisse
morso liscio

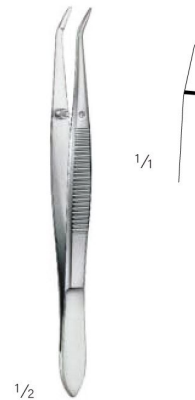

Barraquer
B03-300-11

11 cm / 4 3/8"
glattes Maul
smooth jaw
boca lisa
mors lisse
morso liscio



Splinter Forceps
Splitterpinzetten
Pinzas para espinas
Pincas à échardes
Pinze per scheggie



1/1

B03-301-14
14 cm / 5 4/8"

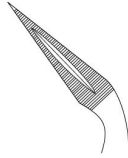

B03-301-13
13,5 cm / 5 3/8"



1/1

Peet
B03-302-12
12,5 cm / 4 7/8"

1/2

Stieglitz
B03-301-14
B03-301-13

1/2



1/1

B03-303-15
15 cm / 5 7/8"

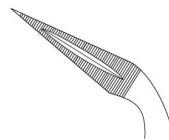

B03-303-14
14 cm / 5 4/8"

1/2

Ralk
B03-303-15
B03-303-14

no one does it BETTER



Cell: 0092 323 9300123

Tel: 0092 52 3563378

URL: <https://bona-dent.com>

Email: info@bona-dent.com

Email: bonadent.mfg@gmail.com

Address:

Kacha Shahab Pura Road

Jeewan Pura, Sialkot (51310)

Pakistan.

