

INCREDIBLY REUSABLE

• FLEXIBLE
USE SURGERY
ASSISTANT



ARTERY +
FORCEPS



An Era Of **evolution**

Bonadent

HAS THE REPUTATION OF BEING THE ONLY IN PAKISTAN THAT MANUFACTURES ITS OWN TOOLS FOR THE PRODUCTION OF ITS INSTRUMENTS.

Bonadent is a privately owned company providing personalized services and the finest in Surgical Instruments for over 25 years. Established in 1999, Our Company manufactures a wide range of Surgical, Dental and Veterinary Instruments.

All Instruments and devices of our product range are manufactured by well-trained and experienced skilled workers with special craftsmanship and by use of most modern machines and equipment. On this occasion we only use materials which meet our high standards. The CEO of Bonadent Manufacturing co, Mr. Muhammad Ibrahim brings with him a lifetime of knowledge about the world of surgical instruments.

This insight allows us to understand the needs of our customers in a way most other instrument companies are unable to do.

After becoming a competent oem service provider, cardiac has decided to introduce itself as the original source of high quality instrumentation to directly interact with some of the well-known brands around the world.

Clip Applying Forceps, Vessel Clips

Clip-Anlegepinzette, Gefäßclips
 Pinzas para aplicar clips,
 Pincas pour poser les clips vasculaires, Clips vasculaires
 Pinze per applicazione clips vascolari,



Biemer
B04-100-16
 16 cm / 6 3/8"
 Gefäßspreizer
 Vascular spreader
 Dilatador de vasos
 Ecarteur vasculaire
 Dilatatore vascolare



B04-101-14
 14,5 cm / 5 7/8"
 ohne Sperre
 w/o ratchet
 sin cremallera
 sans crémaillère
 senza cremagliera



B04-102-14
 14,5 cm / 5 7/8"
 mit Sperre
 with ratchet
 con cremallera
 avec crémaillère
 con cremagliera

➔ **B04-103-04**
B04-110-04

➔ **B04-103-04**
B04-110-04



Biemer
B04-103-04
B04-104-05

1/4



St	C04-103-04	C04-103-05	C04-104-05
	14 mm	17 mm	17 mm
	6 mm	9 mm	9 mm
	4 mm	7 mm	7 mm
P	30 - 40 g	30 - 40 g	20 - 25 g



Vessel Clips, Approximators
 Gefäßclips, Approximatoren
 Clips vasculares, Aproximadores
 Clips vasculaires, Approximateurs
 Clip vascolari, Approssimatori



Biemer-Müller
B04-105-05
B04-109-05



	gerade, breit straight, wide recto, ancho droit, large retto, largo	gewinkelt, breit angled, wide angulado, ancho coudé, large angulato, largo	gerade, schmal straight, narrow recto, estrecho droit, étroit retto, stretto	gerade, schmal straight, narrow recto, estrecho droit, étroit retto, stretto	gewinkelt, schmal angled, narrow angulado, estrecho coudé, étroit angulato, stretto
St	B04-105-05	B04-106-05	B04-107-03	B04-108-05	B04-109-05
	17 mm	17 mm	13 mm	17 mm	17 mm
	9 mm	9 mm	6 mm	9 mm	9 mm
	7 mm	7 mm	4 mm	7 mm	7 mm
P	30 - 40 g	30 - 40 g	30 - 40 g	30 - 40 g	25 - 30 g



Müller
B04-110-01
B04-110-04



Ø	1,5 mm	2,5 mm	3,0 mm	3,5 mm
St	B04-110-01	B04-110-02	B04-110-03	B04-110-04
	17 mm	17 mm	17 mm	17 mm
	9 mm	9 mm	9 mm	9 mm
	7 mm	7 mm	7 mm	7 mm
P	30 - 40 g	30 - 40 g	30 - 40 g	30 - 40 g



Approximators, Nerve Approximators
 Approximatoren, Nerv-Approximatoren
 Aproximadores, Aproximadores para nervios
 Approximateurs, Approximateurs pour nerfs
 Approssimatori, Approssimatori per nervi

für Mikro-Gefäßanastomosen in der Tiefe
 for Micro vessel anastomosis in the depth
 para micro anastomosis en la profundidad
 pour micro-anastomoses vasculaires en profondeur
 per micro-anastomosi vascolari nella profondità

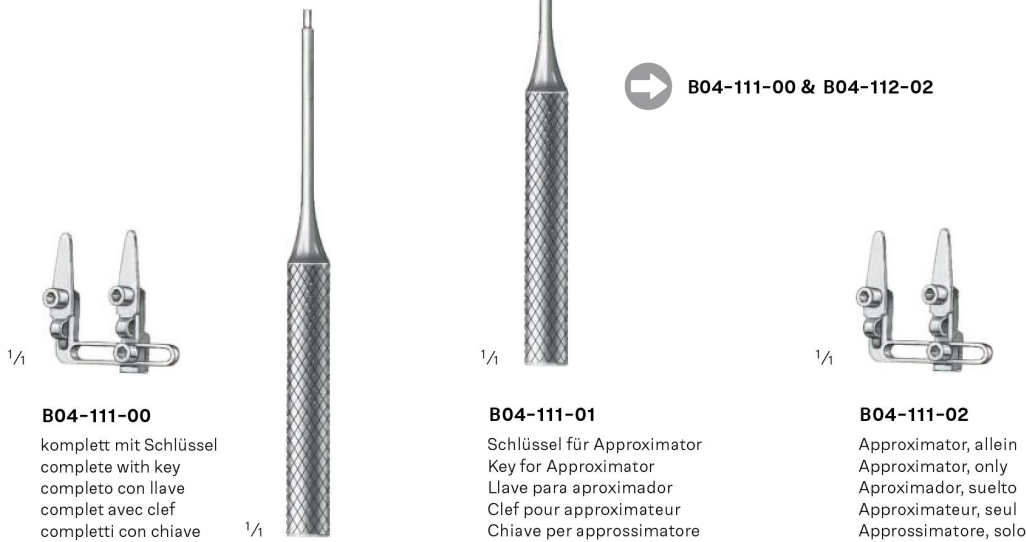

B04-111-00
 komplett mit Schlüssel
 complete with key
 completo con llave
 complet avec clef
 completti con chiave

B04-111-01
 Schlüssel für Approximator
 Key for Approximator
 Llave para aproximador
 Clef pour approximateur
 Chiave per approssimatore

B04-111-02
 Approximator, allein
 Approximator, only
 Aproximador, suelto
 Approximateur, seul
 Approssimatore, solo

Nadeln mit Schlüssel auswechselbar
 needles exchangeable by means of key
 agujas cambiables con llave
 aiguilles échangeable avec la clé
 aghi intercambiabili con una chiave



B04-112-00
 komplett mit Schlüssel
 complete with key
 completo con llave
 complet avec clef
 completti con chiave

B04-112-02
 Approximator mit Nadeln, allein
 Approximator with needles, only
 Aproximador con agujas, suelto
 Approximateur avec aiguille, seul
 Approssimatore con aghi, solo

B04-112-04
 Ersatznadeln, allein
 Spare Needles, only
 Agujas de repuesto, suelto
 Aiguilles de rechange, seul
 Aghi di ricambio, solo

 Paar
 pair
 par
 paire
 paio

B04-112-02

Mini Vessel Clips, Clip Applying Forceps

Mini-Gefäßclips, Clip-Anlegezangen, Bulldogklemmen
 Mini Clips vasculares, Pinzas para aplicar clips
 Micro-clips vasculaires, Pincettes pour poser micro-clips
 Mini-clip vascolari, Pinze per applicare clips vascolari



1/2

➔ B04-115-04
 B04-115-10

B04-113-14

14,5 cm / 5 5/8"

mit Sperre
 with ratchet
 con cremallera
 avec cremailière
 con cremagliera



1/2

➔ B04-115-04
 B04-115-10

B04-114-18

18,5 cm / 7 2/8"

mit Sperre
 with ratchet
 con cremallera
 avec cremailière
 con cremagliera



1/4

**B04-115-04
 B04-115-10**

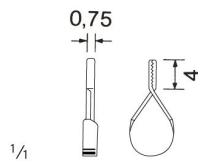

1/4

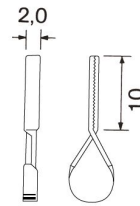
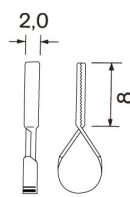
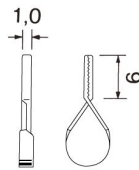

St	B04-115-04	B04-115-06	B04-115-08	B04-115-10
	13 mm	15 mm	17 mm	20 mm
	4 mm	6 mm	8 mm	10 mm
	4 mm	5 mm	6 mm	7 mm
P	60 g	85 g	100 g	125 g



Bulldog Clamps
 Bulldogklemmen
 Clamps Bulldog
 Clamps Bulldog
 Pinze Bulldog

1/2



B04-116-10
B04-117-18

1/4

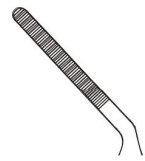

St	B04-116-10	B04-116-14	B04-116-18	B04-117-10	B04-117-14	B04-117-18
	31 mm	35 mm	39 mm	30 mm	33 mm	36 mm
	10 mm	14 mm	18 mm	10 mm	14 mm	18 mm
P	30 g	30 g	30 g	30 g	30 g	30 g

1/2



Dieffenbach
B04-118-06
B04-123-05

1/4



St	B04-118-06	B04-119-06	B04-120-03	B04-121-05	B04-122-03	B04-123-05
	6 cm / 2 3/8"	6 cm / 2 3/8"	3,5 cm / 1 3/8"	5 cm / 2"	3,5 cm / 1 3/8"	5 cm / 2"
	17 mm	17 mm	11 mm	15 mm	11 mm	15 mm

Bulldog Clamps
 Bulldogklemmen
 Clamps Bulldog
 Clamps Bulldog
 Pinze Bulldog



1/2

Johns-Hopkins
B04-124-38
B04-124-90

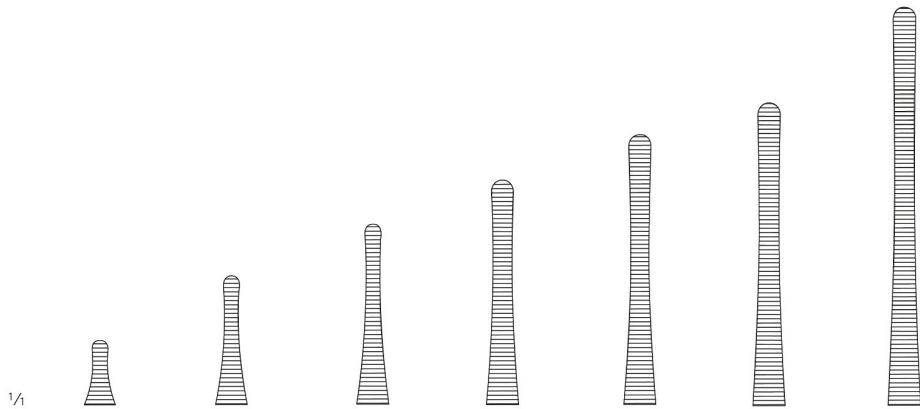

St	B04-124-38	B04-124-45	B04-124-55	B04-124-65	B04-124-70	B04-124-75	B04-124-90
	3,8 cm / 1 3/8"	4,5 cm / 1 5/8"	5,5 cm / 2 1/8"	6,5 cm / 2 4/8"	7 cm / 2 4/8"	7,5 cm / 3"	9 cm / 3 1/8"
	12 mm	17 mm	25 mm	30 mm	35 mm	40 mm	50 mm
P	300 g	300 g	300 g	300 g	300 g	300 g	300 g



1/2

Johns-Hopkins
B04-125-38
B04-125-90

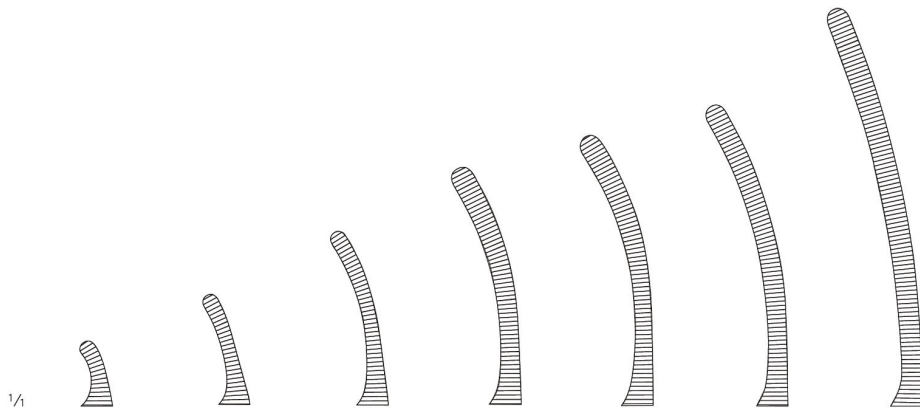

St	B04-125-38	B04-125-45	B04-125-55	B04-125-65	B04-125-70	B04-125-75	B04-125-90
	3,8 cm / 1 3/8"	4,5 cm / 1 5/8"	5,5 cm / 2 1/8"	6,5 cm / 2 4/8"	7 cm / 2 4/8"	7,5 cm / 3"	9 cm / 3 1/8"
	12 mm	17 mm	25 mm	30 mm	35 mm	40 mm	50 mm
P	300 g	300 g	300 g	300 g	300 g	300 g	300 g



Bulldog Clamps
 Bulldogklemmen
 Clamps Bulldog
 Clamps Bulldog
 Pinze Bulldog



1/2

Diethrich
 B04-126-08
 B04-127-12

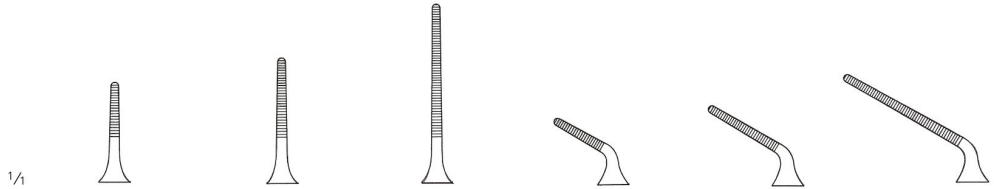

1/4

St	B04-126-08	B04-126-10	B04-126-12	B04-127-08	B04-127-10	B04-127-12
	45 mm	50 mm	60 mm	40 mm	45 mm	50 mm
	8 mm	12 mm	20 mm	8 mm	12 mm	20 mm
	50 g	50 g	50 g	50 g	50 g	50 g

Atrauma



1/4

St	B04-128-10	B04-128-14	B04-128-20	B04-130-10	B04-130-14	B04-130-20
	45 mm	50 mm	60 mm	35 mm	45 mm	50 mm
	10 mm	14 mm	20 mm	10 mm	14 mm	20 mm
	100 g	100 g	100 g	100 g	100 g	100 g



1/2

DeBakey-Diethrich
 B04-128-10
 B04-134-20

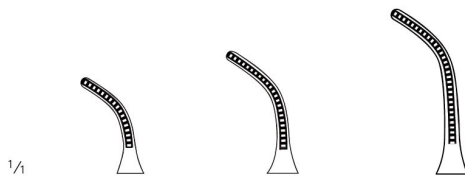

1/4

St	B04-132-10	B04-132-14	B04-133-20
	35 mm	45 mm	50 mm
	10 mm	14 mm	20 mm
	100 g	100 g	100 g



Bulldog Clamps
 Bulldogklemmen
 Clamps Bulldog
 Clamps Bulldog
 Pinze Bulldog



1/4

Müller
 B04-135-13
 B04-144-12

St	B04-135-13	B04-136-13	B04-137-17	B04-138-13	B04-139-12
	40 mm	40 mm	40 mm	40 mm	40 mm
	13 mm	13 mm	17 mm	13 mm	12 mm
	13 mm	13 mm	14 mm	13 mm	12 mm
	50 g	50 g	50 g	50 g	50 g

St	B04-140-13	B04-141-13	B04-142-17	B04-143-13	B04-144-12
	40 mm	40 mm	40 mm	40 mm	40 mm
	13 mm	13 mm	17 mm	13 mm	12 mm
	13 mm	13 mm	14 mm	13 mm	12 mm
	80 g	80 g	80 g	80 g	80 g

* kniegebogen
 knee-bent
 acodado tipo rodilla
 genouillé
 a ginocchiera

Atrauma



1/2

B04-145-38
B04-146-50

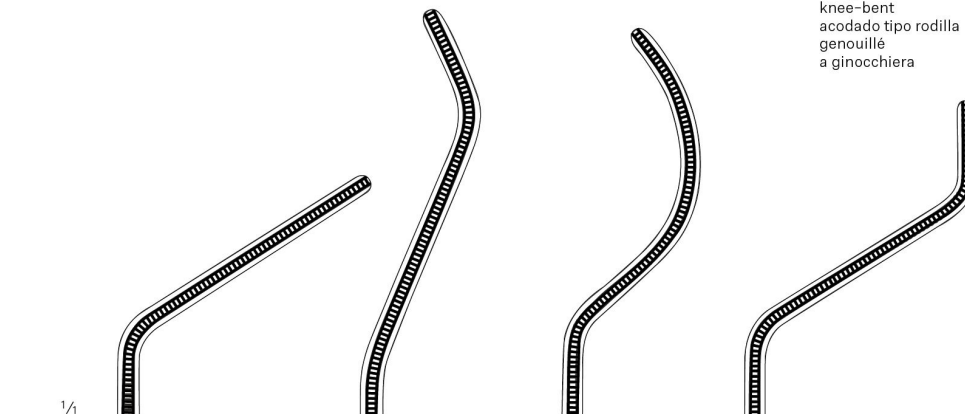

St	B04-145-38	B04-145-65	B04-145-60	B04-145 B50
	95 mm	120 mm	110 mm	105 mm
	38 mm	65 mm	60 mm	50 mm
	250 g	250 g	250 g	250 g

St	B04-146-38	B04-146-65	B04-146-60	B04-146-50
	95 mm	120 mm	110 mm	105 mm
	38 mm	65 mm	60 mm	50 mm
	350 g	350 g	350 g	350 g



Atrauma



1/1

Mini-Glover
 B04-147-30
 B04-148-50

1/1



Vena				
Ti	B04-147-30	B04-147-35	B04-147-40	B04-147-50
	30 mm	35 mm	40 mm	50 mm
	9 mm	13 mm	14 mm	23 mm
P	110 +/- 10 g	110 +/- 10 g	110 +/- 10 g	110 +/- 10 g

Arteria				
Ti	B04-148-30	B04-148-35	B04-148-40	B04-148-50
	30 mm	35 mm	40 mm	50 mm
	9 mm	13 mm	14 mm	23 mm
P	220 +/- 10 g	220 +/- 10 g	220 +/- 10 g	220 +/- 10 g

Atrauma



1/1

Mini-Glover
 B04-149-30
 B04-150-50

1/1



Vena				
Ti	B04-149-30	B04-149-35	B04-149-40	B04-149-50
	30 mm	35 mm	40 mm	50 mm
	9 mm	13 mm	14 mm	23 mm
P	110 +/- 10 g	110 +/- 10 g	110 +/- 10 g	110 +/- 10 g

Arteria				
Ti	B04-150-30	B04-150-35	B04-150-40	B04-150-50
	30 mm	35 mm	40 mm	50 mm
	9 mm	13 mm	14 mm	23 mm
P	220 +/- 10 g	220 +/- 10 g	220 +/- 10 g	220 +/- 10 g

Bulldog Clamps
 Bulldogklemmen
 Clamps Bulldog
 Clamps Bulldog
 Pinze Bulldog

Atrauma

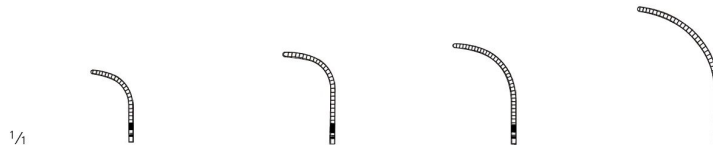

Mini-Glover
 B04-152-30
 B04-153-50

Vena				
Ti	B04-152-30	B04-152-35	B04-152-40	B04-152-50
	30 mm	35 mm	40 mm	50 mm
	9 mm	13 mm	14 mm	23 mm
P	110 +/- 10 g	110 +/- 10 g	110 +/- 10 g	110 +/- 10 g

Arteria				
Ti	B04-153-30	B04-153-35	B04-153-40	B04-153-50
	30 mm	35 mm	40 mm	50 mm
	9 mm	13 mm	14 mm	23 mm
P	220 +/- 10 g	220 +/- 10 g	220 +/- 10 g	220 +/- 10 g



1/2

Mini-Glover
C04-154-24

24 cm / 9 4/8"

Anlegezange für Bulldogklemmen, Mini-Glover
 Applying Forceps for Bulldog clamps, Mini-Glover
 Pinza applicadora para clamps bulldog, Mini-Glover
 Pince pour poser les clamps Bulldog, Mini-Glover
 Pinza per posizionare le pinze Bulldog, Mini-Glover

C04-152-30
 C04-153-50





1/2

Pean
 B04-155-14
 B04-155-16



1/4

B04-155-14
 14,5 cm / 5 9/16"



B04-155-16
 16 cm / 6 2/8"



1/2

Spencer-Wells
 B04-156-13
 B04-157-20

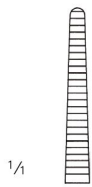

1/4

B04-156-13
 13 cm / 5 1/8"



B04-156-14
 14,5 cm / 5 9/16"



B04-156-15
 15,5 cm / 6 1/8"



B04-156-18
 18,5 cm / 7 3/8"



B04-156-20
 20 cm / 7 7/8"



1/4

B04-157-13
 13 cm / 5 1/8"



B04-157-14
 14 cm / 5 5/16"



B04-157-15
 15 cm / 5 7/8"



B04-157-18
 18 cm / 7 1/8"



B04-157-20
 20 cm / 7 7/8"

Haemostatic Forceps, Organ Grasping Forceps
 Arterienklemmen, Organfasszangen
 Pinzas hemostáticas, Pinzas para sacar órganos
 Pinces hémostatiques, Pinces pour saisir organes
 Pinze emostatiche, Pinze per afferrare organi



Chaput
B04-158-12
 12,5 cm / 4 7/8"



Tuffier
B04-159-12
 12,5 cm / 4 7/8"

Atrauma



B04-160-25
B04-160-26



B04-160-25
 25 cm / 9 7/8"

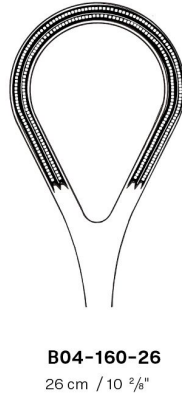

B04-160-26
 26 cm / 10 2/8"



Organ Grasping Forceps
 Organfasszangen
 Pinzas para sacar órganos
 Pincas pour saisir organes
 Pinze per afferrare organi



Collin
B04-161-14
 14 cm / 5 4/8"

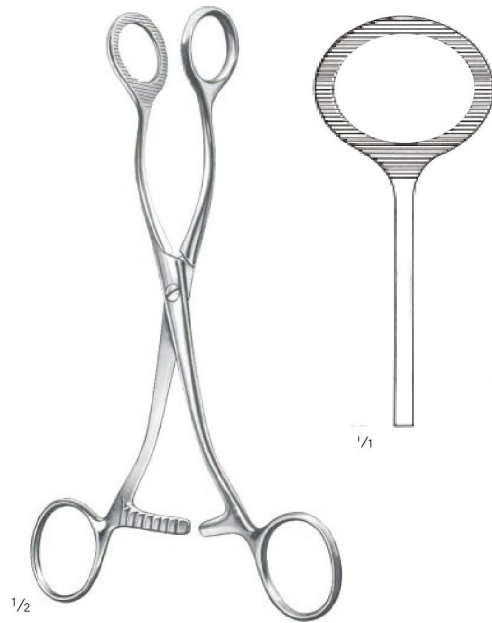

Collin
B04-162-17
 17 cm / 6 5/8"
 Tumorfasszange
 Tumor Grasping Forceps
 Pinzas para sacar órganos
 Pincas à tumeurs à vis
 Pinze per afferrare tumori

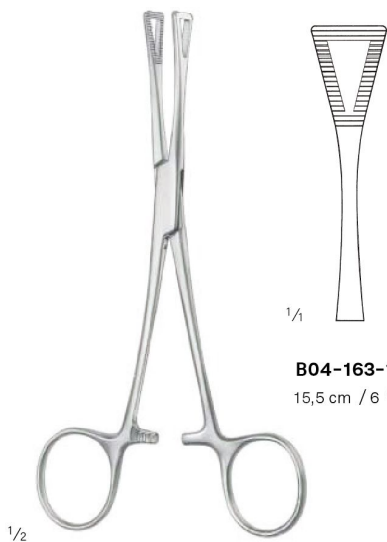

Pennington
B04-163-15
B04-163-21

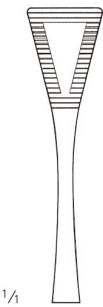

B04-163-15
 15,5 cm / 6 1/8"

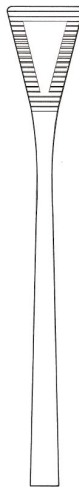

B04-163-21
 21 cm / 8 3/8"



Pratt
B04-164-15
 15 cm / 5 7/8"

Haemostatic Forceps, Dissecting and Ligature Forceps
 Arterienklemmen, Präparierklemmen
 Pinzas hemostáticas, Pinzas para preparación y ligadura
 Pinces hémostatiques, Pinces à dissecquer et à ligatures
 Pinze emostatiche, Pinze per preparazioni e legature

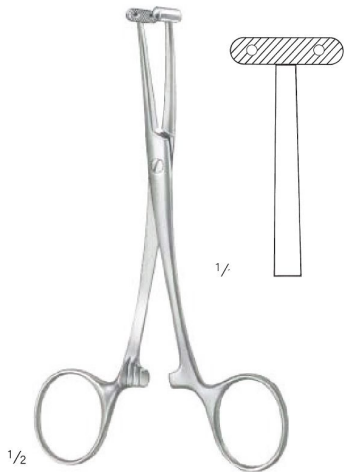

Martel-Rees

B04-165-13

13,5 cm / 5 3/8"
 Face-lift-Klemme
 Face-lift Forceps
 Pinza para Face-lift
 Pinces pour Face-lift
 Pinze per Face-lift



B04-166-12

12,5 cm / 4 7/8"
 Fadenklemme, glattes Maul
 Ligature Forceps, smooth jaw
 Pinza para hilos, boca lisa
 Pince à ligatures, mors lisse
 Pinza per legature, morso liscio



Mixer-Baby

B04-167-13

B04-168-13

13,5 cm / 5 3/8"

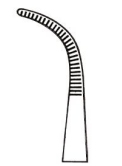

13 cm / 5 1/8"



Mikro-Adson

B04-169-14

14 cm / 5 1/2"

1/2

Baby-Adson

B04-170-18

18 cm / 7 1/8"



Haemostatic Forceps
 Arterienklemmen
 Pinzas hemostáticas
 Pincès hémostatiques
 Pinze emostatiche

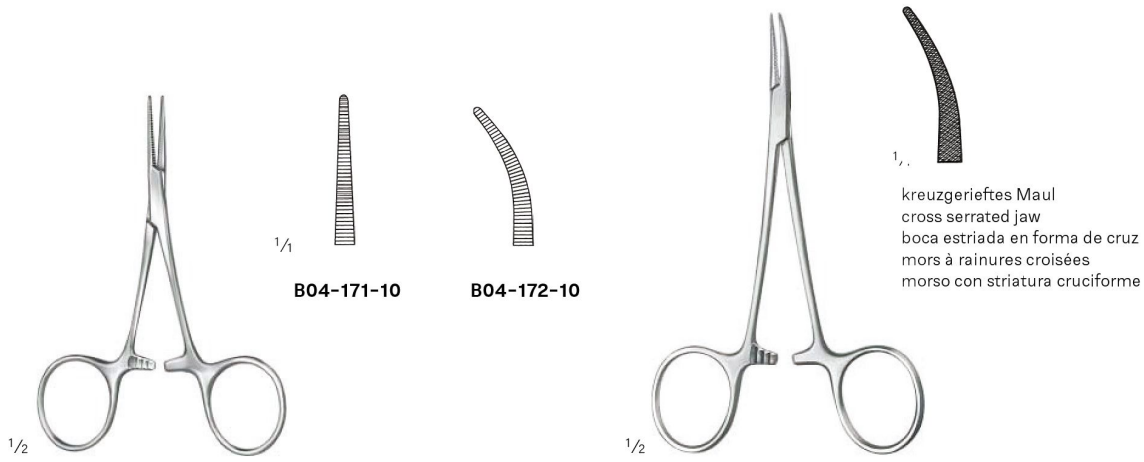

Hartmann
B04-171-10
B04-172-10
 10 cm / 3 7/8"

B04-173-12
 12 cm / 4 9/8"
 Fadenklemme
 Ligature Forceps
 Pinza para hilos
 Pince à ligatures
 Pinza per legature

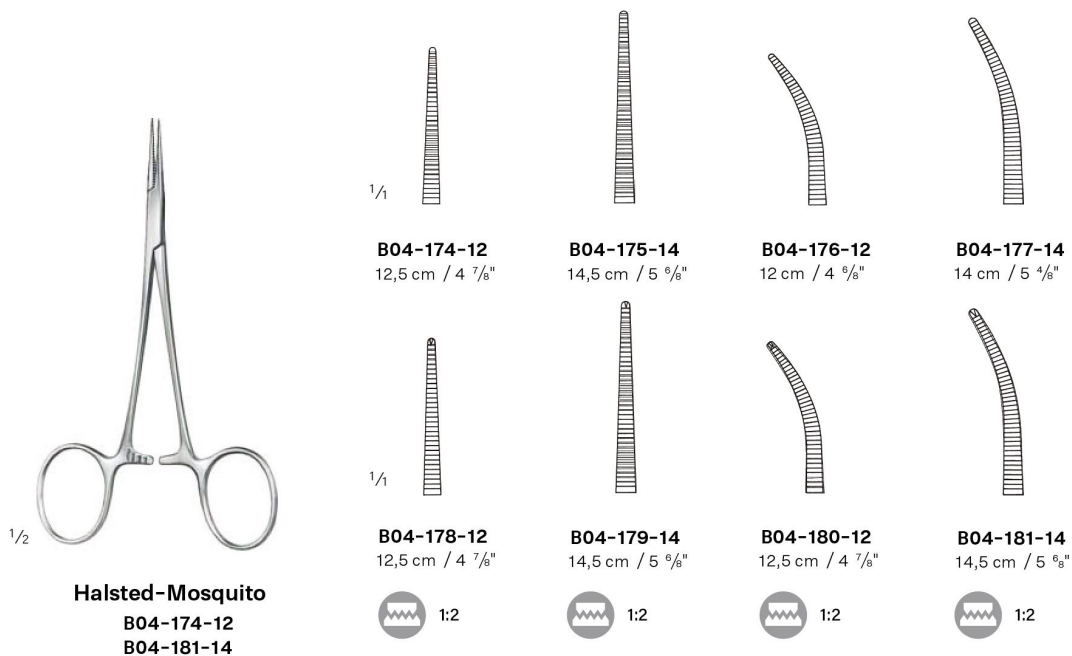

Halsted-Mosquito
B04-174-12
B04-181-14

B04-174-12
 12,5 cm / 4 7/8"

B04-175-14
 14,5 cm / 5 9/8"

B04-176-12
 12 cm / 4 9/8"

B04-177-14
 14 cm / 5 5/8"

B04-178-12
 12,5 cm / 4 7/8"

B04-179-14
 14,5 cm / 5 9/8"

B04-180-12
 12,5 cm / 4 7/8"

B04-181-14
 14,5 cm / 5 9/8"

Haemostatic Forceps
 Arterienklemmen
 Pinzas hemostáticas
 Pinces hémostatiques
 Pinze emostatiche



1/2

Halsted-Mosquito

B04-182-12
B04-185-12

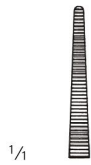

1/4

B04-182-12
 12,5 cm / 4 7/8"



B04-183-12
 12 cm / 4 5/8"



B04-184-12
 12 cm / 4 5/8"



B04-185-12
 12 cm / 4 5/8"



1/2

Halsted-Mosquito

B04-186-18
B04-193-20

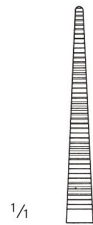

1/4

B04-186-18
 18,5 cm / 7 2/8"



B04-187-21
 21 cm / 8 2/8"



B04-188-18
 18 cm / 7 1/8"

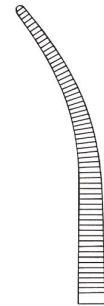

B04-189-20
 20,5 cm / 8 1/8"



1/4

B04-190-18
 18,5 cm / 7 2/8"



B04-191-21
 21 cm / 8 2/8"



B04-192-18
 18 cm / 7 1/8"

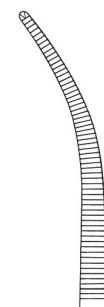

B04-193-20
 20,5 cm / 8 1/8"

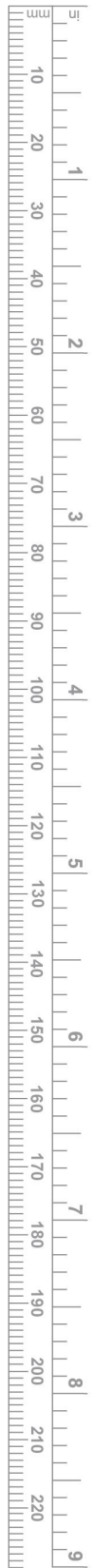

Haemostatic Forceps
 Arterienklemmen
 Pinzas hemostáticas
 Pincas hémostatiques
 Pinze emostatiche

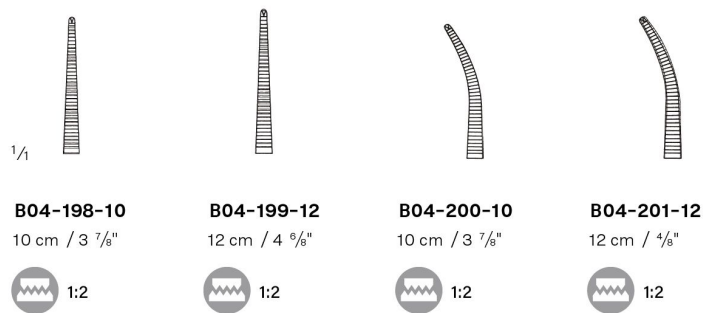
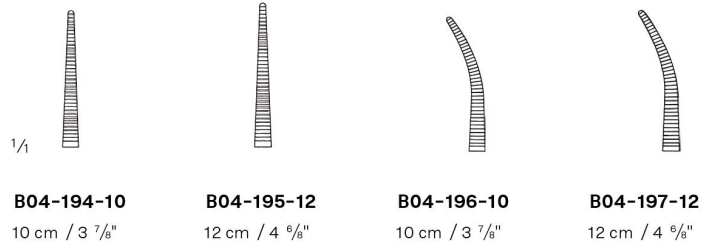

Mikro-Mosquito
 B04-194-10
 B04-201-12



Providence-Hospital
 B04-202-14
 B04-202-13

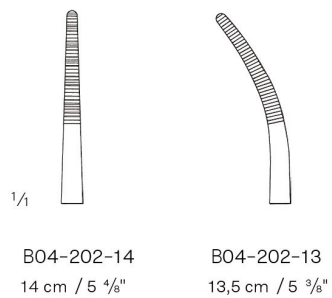

Leriche
 B04-203-15
 B04-206-15

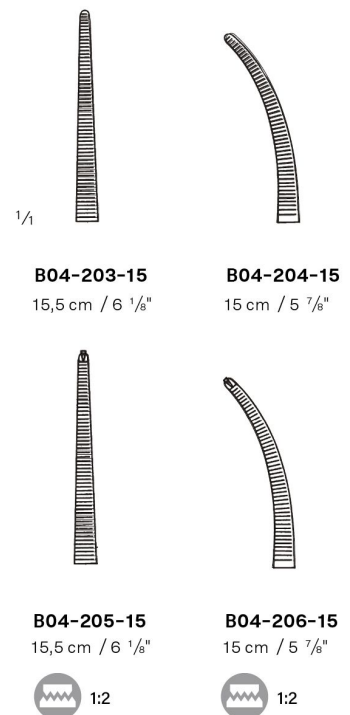

Haemostatic Forceps
 Arterienklemmen
 Pinzas hemostáticas
 Pinces hémostatiques
 Pinze emostatiche



Kelly
 B04-207-14
 B04-210-14

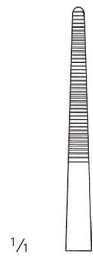

B04-207-14
 14,5 cm / 5 9/16"



B04-208-14
 14,5 cm / 5 9/16"



B04-209-14
 14 cm / 5 4/8"



B04-210-14
 14 cm / 5 4/8"



Dunhill
 B04-211-12
 12,5 cm / 4 7/8"

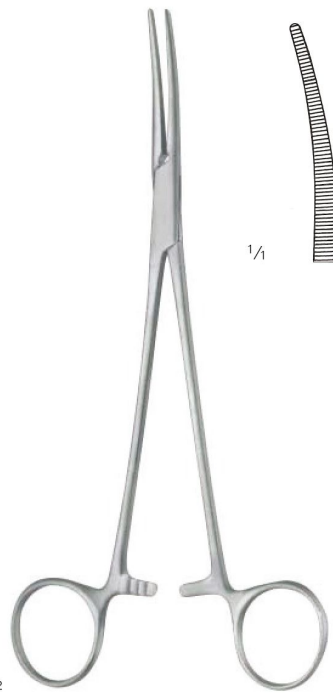

Dunhill
 B04-212-18
 18,5 cm / 7 3/8"



Haemostatic Forceps, Dissecting and Ligature Forceps
 Arterienklemmen, Präparierklemmen
 Pinzas hemostáticas, Pinzas para preparación y ligadura
 Pinces hémostatiques, Pinces à dissecquer et à ligatures
 Pinze emostatiche, Pinze per preparazioni e legature



Kelly-Rankin

B04-213-16
 B04-214-16

16 cm / 6 2/8"

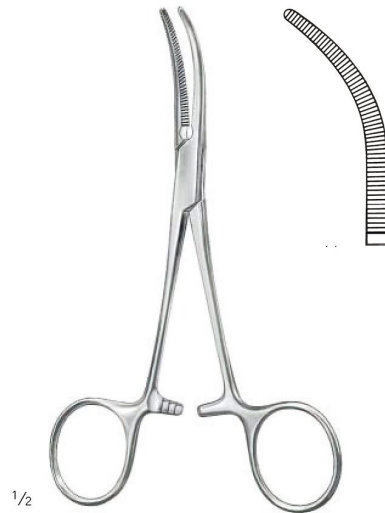

Overholt-Baby

B04-215-13
 13,5 cm / 5 3/8"

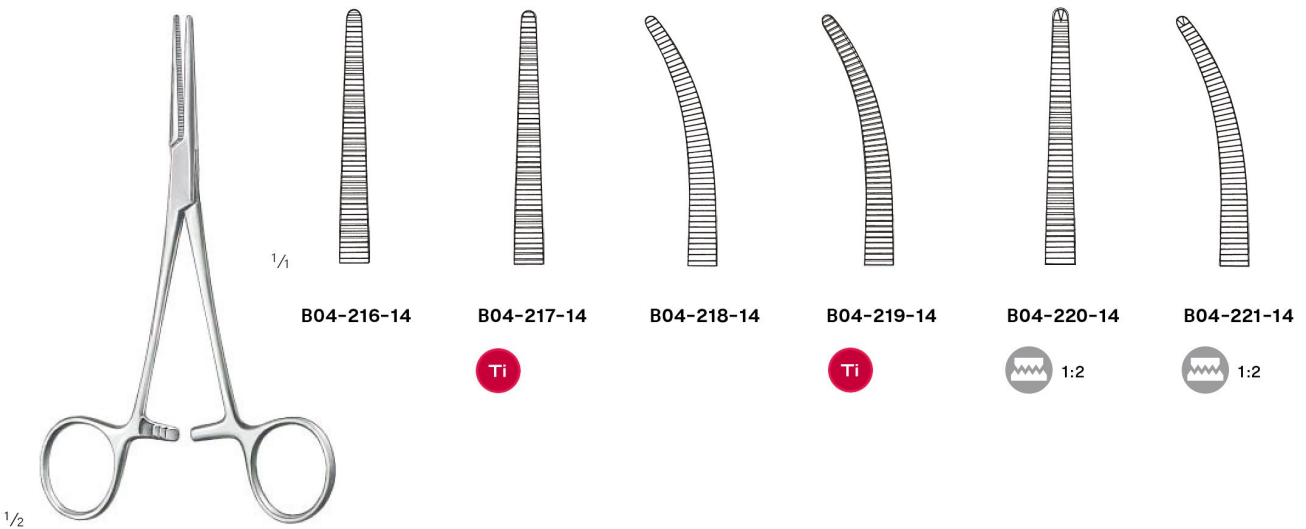

Crile

B04-216-14
 B04-221-14

14,5 cm / 5 9/16"





Crile-Rankin

B04-222-16
B04-223-16
 16 cm / 6 3/8"

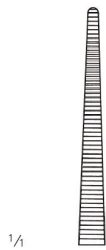

B04-222-16

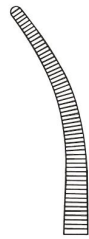

B04-223-16



Lovelace

B04-224-16
B04-225-16
 16 cm / 6 3/8"

kreuzgerieftes Maul
 cross serrated jaw
 boca estriada en forma de cruz
 mors à rainures croisées
 morso con striatura cruciforme



B04-224-16



B04-225-16



Dandy-Mosquito

B04-226-12
 12 cm / 4 3/8"
 seitlich gebogen
 laterally curved
 curva lateralmente
 courbe lateralement
 curva laterale

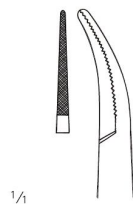

Dandy

B04-227-14
B04-228-14
 14 cm / 5 1/2"
 seitlich gebogen
 laterally curved
 curva lateralmente
 courbe lateralement
 curva laterale

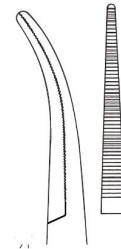

B04-227-14
 14,5 cm / 5 3/8"

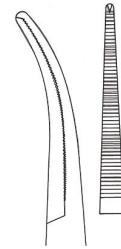

B04-228-14
 14 cm / 5 1/2"



Haemostatic Forceps, Dissecting and Ligature Forceps
 Arterienklemmen, Präparierklemmen
 Pinzas hemostáticas, Pinzas para preparación y ligadura
 Pinces hémostatiques, Pinces à dissequer et à ligatures
 Pinze emostatiche, Pinze per preparazioni e legature



B04-229-18
 18,5 cm / 7 2/8"



B04-229-19
 19 cm / 7 4/8"



1/1

B04-230-19
 19 cm / 7 4/8"



B04-230-18
 18,5 cm / 7 2/8"

Schnidt
B04-229-18
B04-229-19

Adson
B04-230-19
B04-230-18



Martin-Fuchsig
B04-231-20
 20,5 cm / 8 1/8"



Rochester-Carmalt
B04-232-17
B04-235-20

1/1

B04-232-17
 17 cm / 6 5/8"



B04-233-20
 20,5 cm / 8 1/8"



B04-234-16
 16,5 cm / 6 4/8"



B04-235-20
 20 cm / 7 7/8"

Haemostatic Forceps
 Arterienklemmen
 Pinzas hemostáticas
 Pinces hémostatiques
 Pinze emostatiche



Pean
 B04-236-13
 B04-241-16



B04-236-13
 13,5 cm / 5 3/8"



B04-237-14
 14,5 cm / 5 9/16"



B04-238-17
 17 cm / 6 5/8"



B04-239-13
 13 cm / 5 1/8"



B04-240-14
 14 cm / 5 4/8"



B04-241-16
 16,5 cm / 6 4/8"



Pean-Nippon
 B04-242-14
 B04-247-18

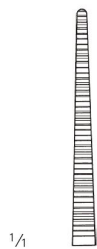

B04-242-14
 14,5 cm / 5 9/16"



B04-243-16
 16,5 cm / 6 4/8"



B04-244-18
 18,5 cm / 7 3/8"



B04-245-14
 14 cm / 5 4/8"



B04-246-16
 16 cm / 6 3/8"

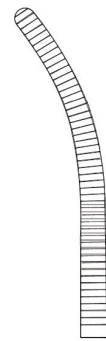

B04-247-18
 18 cm / 7 1/8"

Haemostatic Forceps
 Arterienklemmen
 Pinzas hemostáticas
 Pinces hémostatiques
 Pinze emostatiche

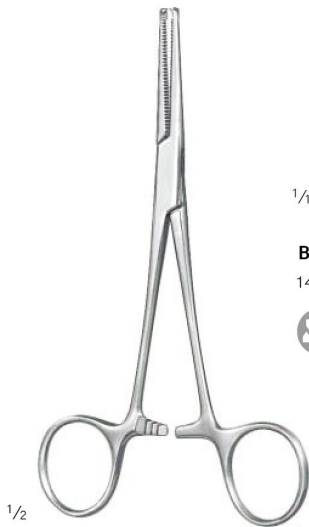

Kocher-Nippon
 B04-248-14
 B04-253-18

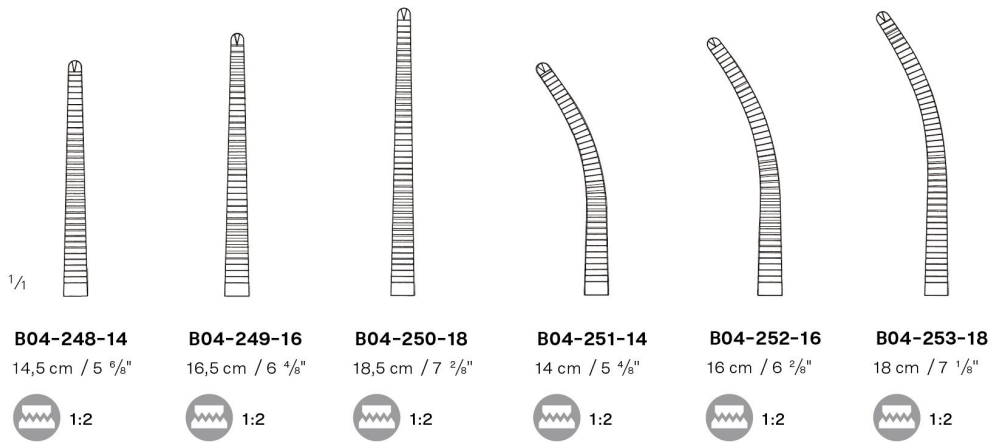

Kocher
 B04-254-13
 B04-259-16

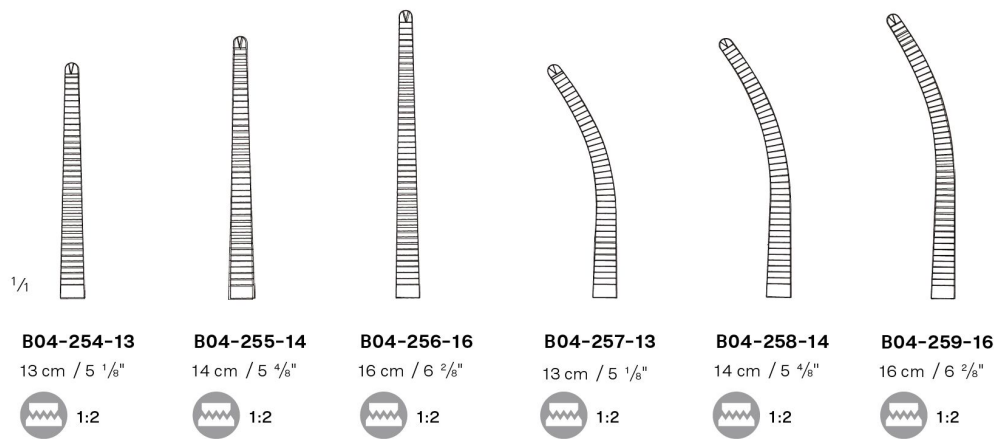

Haemostatic Forceps
 Arterienklemmen
 Pinzas hemostáticas
 Pinces hémostatiques
 Pinze emostatiche



1/1

B04-260-21
 21,5 cm / 8 4/8"



B04-261-26
 26 cm / 10 2/8"



B04-262-21
 21,5 cm / 8 4/8"



B04-263-26
 26 cm / 10 2/8"

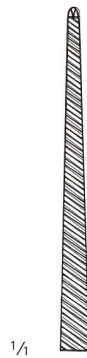

1/1

B04-264-21
 21,5 cm / 8 4/8"



B04-265-26
 26 cm / 10 2/8"



B04-266-21
 21,5 cm / 8 4/8"



B04-267-26
 26 cm / 10 2/8"



1/2

Bengolea
B04-260-21
B04-267-26

Haemostatic Forceps
 Arterienklemmen
 Pinzas hemostáticas
 Pinces hémostatiques
 Pinze emostatiche

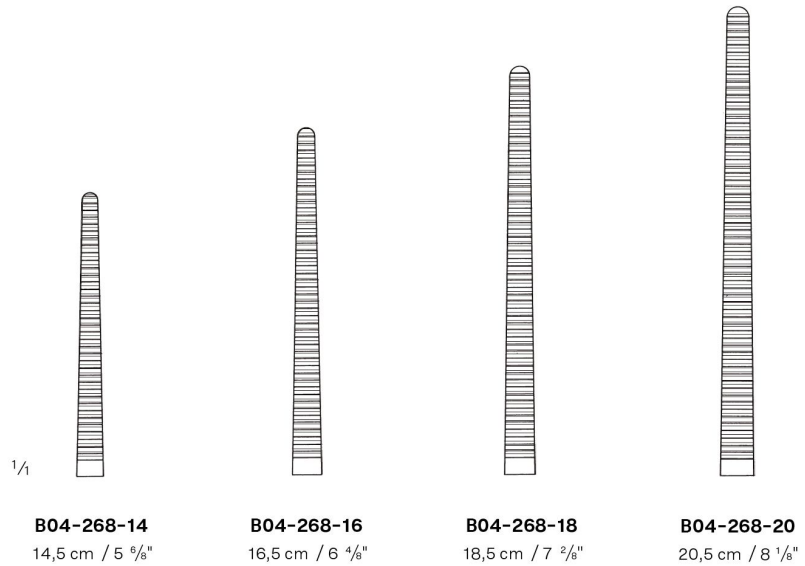

Pean (Rochester)
 B04-268-14
 B04-268-31

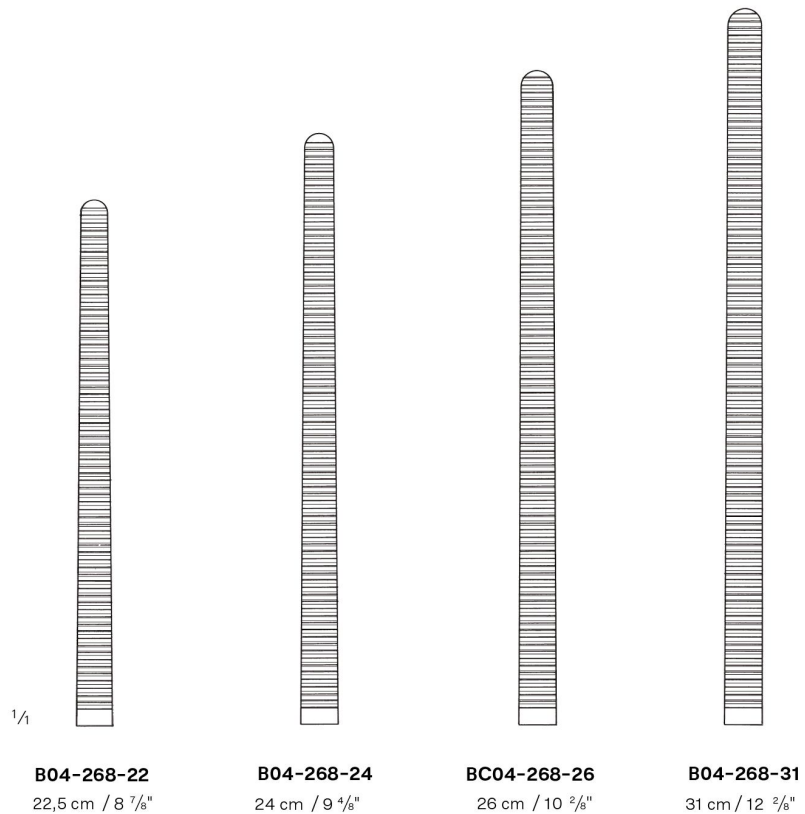

Haemostatic Forceps
 Arterienklemmen
 Pinzas hemostáticas
 Pinces hémostatiques
 Pinze emostatiche

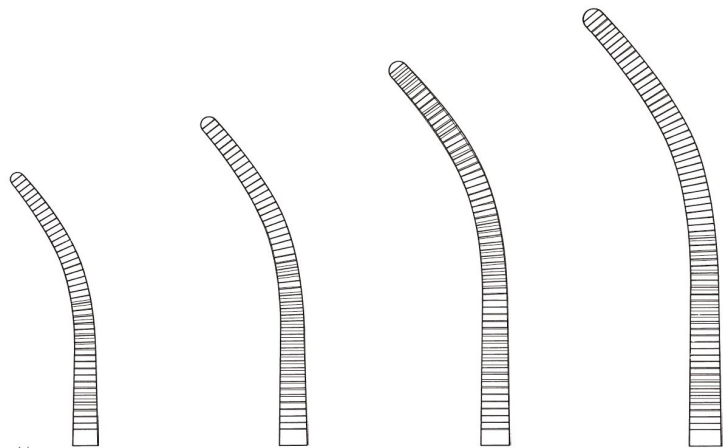

B04-269-14
 14 cm / 5 4/8"

B04-269-16
 16,5 cm / 6 4/8"

B04-269-18
 18,5 cm / 7 2/8"

B04-269-20
 20,5 cm / 8 1/8"



1/2

Pean (Rochester)

B04-269-14
B04-269-30

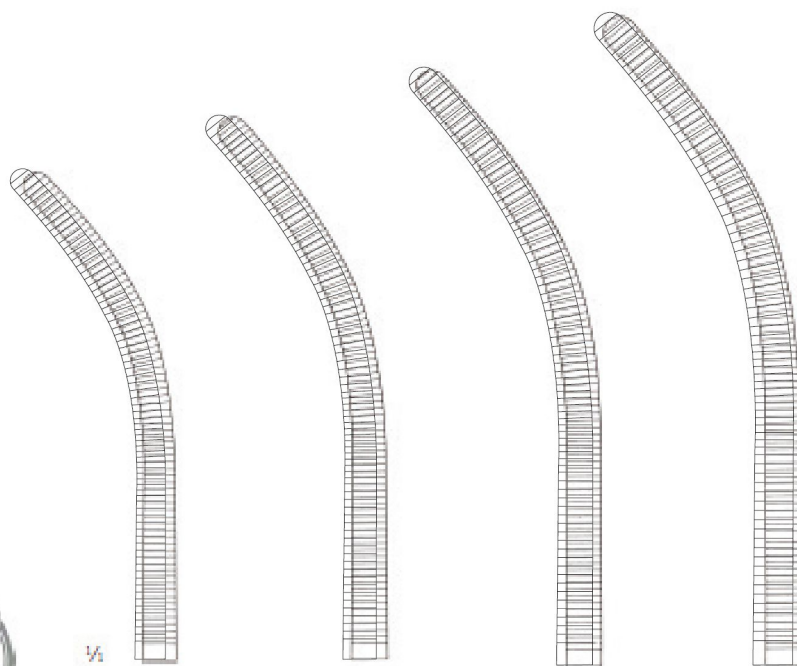

B04-269-22
 22 cm / 8 5/8"

B04-269-24
 24 cm / 9 4/8"

B04-269-26
 26 cm / 10 2/8"

B04-269-30
 30,5 cm / 12"



Haemostatic Forceps
 Arterienklemmen
 Pinzas hemostáticas
 Pinces hémostatiques
 Pinze emostatiche

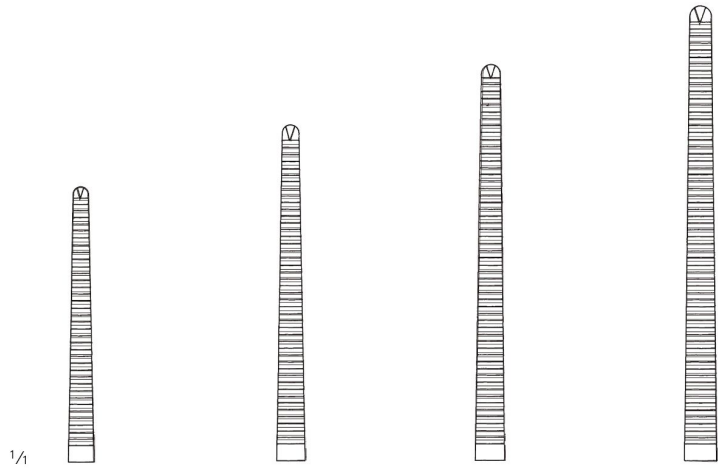

B04-270-14
 14,5 cm / 5 7/8"



B04-270-16
 16,5 cm / 6 4/8"



B04-270-18
 18,5 cm / 7 3/8"



B04-270-20
 20,5 cm / 8 1/8"



1/2

Kocher (Ochsner)
 B04-270-14
 B04-270-31

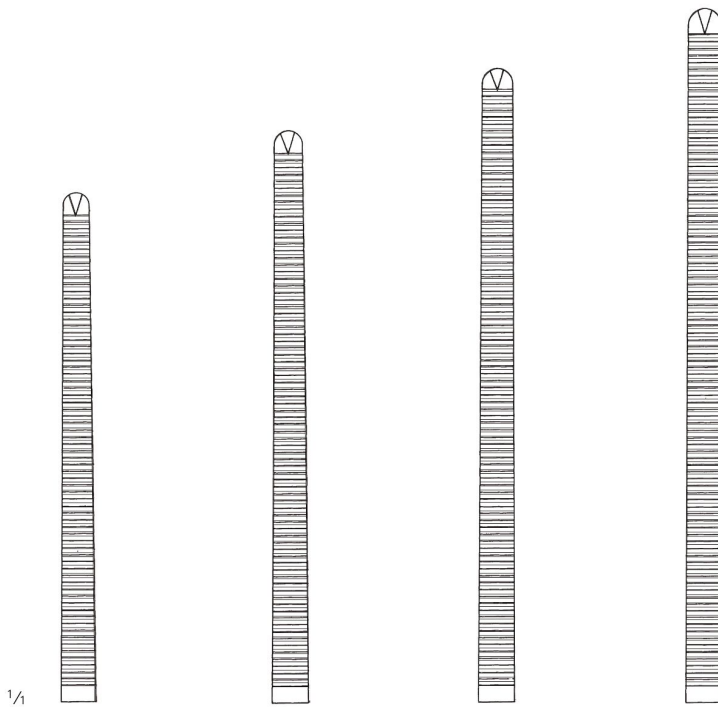

B04-270-22
 22,5 cm / 8 7/8"



B04-270-24
 24 cm / 9 4/8"



B04-270-26
 26 cm / 10 2/8"



B04-270-31
 31 cm / 12 2/8"



Haemostatic Forceps
 Arterienklemmen
 Pinzas hemostáticas
 Pinces hémostatiques
 Pinze emostatiche

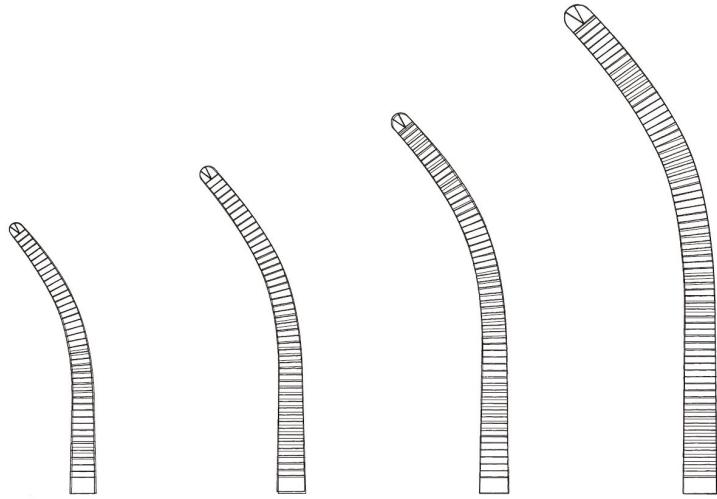

B04-271-14
 14 cm / 5 5/8"



B04-271-16
 16,5 cm / 6 4/8"



B04-271-18
 18,5 cm / 7 2/8"



B04-271-20
 20 cm / 7 7/8"



1/2

Kocher (Ochsner)

B04-271-14
B04-271-31

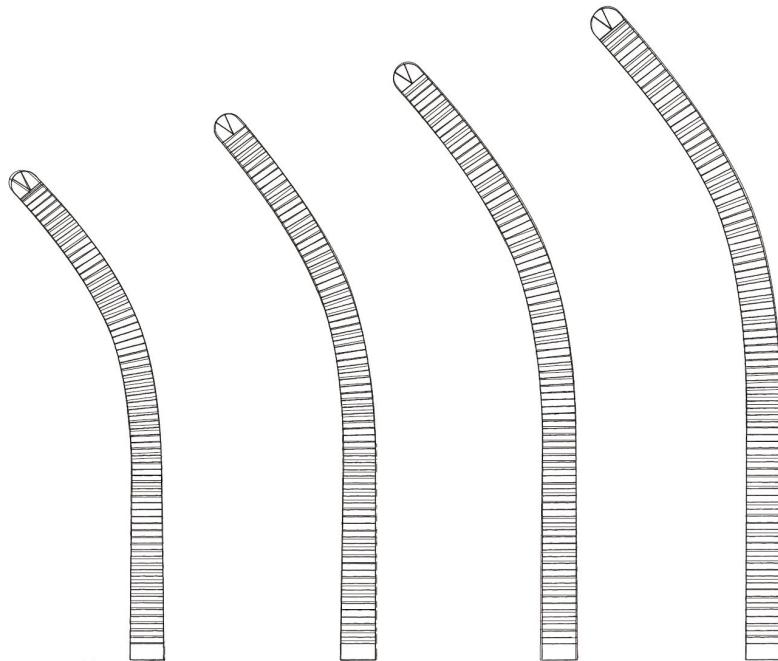

B04-271-22
 22,5 cm / 8 7/8"



B04-271-24
 24 cm / 9 4/8"



B04-271-26
 26 cm / 10 2/8"



B04-271-30
 30,5 cm / 12"



Dissecting and Ligature Forceps
 Präparierklemmen
 Pinzas para preparación y ligadura
 Pincès à disséquer et à ligatures
 Pinze per preparazioni e legature



Fig. 1
B04-272-18
 18,5 cm / 7 2/8"

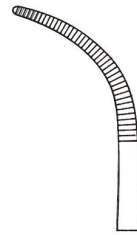

Fig. 2
B04-273-20
 20,5 cm / 8 1/8"

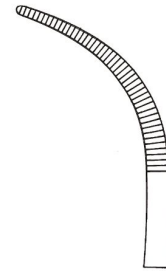

Fig. 3
B04-274-21
 21 cm / 8 2/8"



Overholt-Martin
B04-272-18
B04-276-24

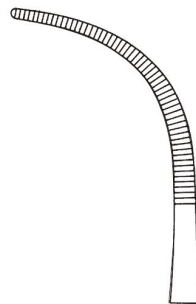

Fig. 4
B04-275-21
 21,5 cm / 8 2/8"

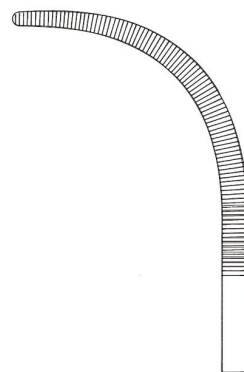

Fig. 5
B04-276-24
 24,5 cm / 9 5/8"

1/2

Dissecting and Ligature Forceps

Präparierklemmen
 Pinzas para preparación y ligadura
 Pinces à disséquer et à ligatures
 Pinze per preparazioni e legature



1/2

Mixer-Baby
B04-277-18
 18,5 cm / 7 2/8"



1/2

Adson-Baby
B04-278-14
B04-278-18



B04-278-14
 14,5 cm / 5 6/8"

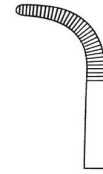

B04-278-18
 18 cm / 7 1/8"



1/2

Heiss
B04-279-21
B04-281-21

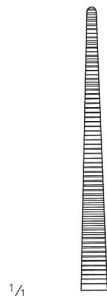

1/1

B04-279-21
 21 cm / 8 2/8"

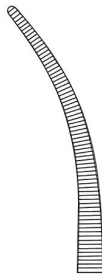

B04-280-20
 20,5 cm / 8 1/8"



B04-281-21
 21 cm / 8 2/8"



1/2

Overholt-Mixer
B04-282-22
 22 cm / 8 5/8"

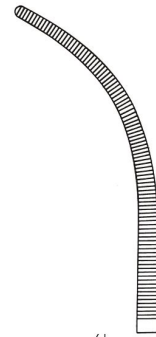

1/1



Dissecting and Ligature Forceps
 Präparierklemmen
 Pinzas para preparación y ligadura
 Pincès à disséquer et à ligatures
 Pinze per preparazioni e legature



1/1

B04-283-22
 22,5 cm / 8 7/8"

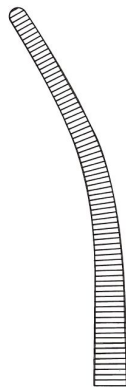

B04-284-22
 22 cm / 8 5/8"



1/1

B04-285-25
 25 cm / 9 7/8"

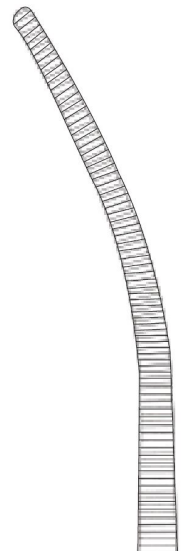

B04-285-24
 24,5 cm / 9 5/8"

Roberts
 B04-283-22
 B04-284-22

Sarot
 B04-285-25
 B04-285-24

Dissecting and Ligature Forceps
 Präparierklemmen
 Pinzas para preparación y ligadura
 Pinces à disséquer et à ligatures
 Pinze per preparazioni e legature



Crafoord
 B04-286-18
 B04-286-24

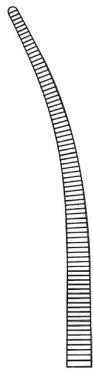

B04-286-18
 18,5 cm / 7 3/8"



B04-286-24
 24,5 cm / 9 5/8"



Crafoord-Sellors
 B04-287-22
 B04-287-24

Gefäßklemme
 Vascular clamp
 Pinza para vasos
 Pince vasculaires
 Pinza vascolari

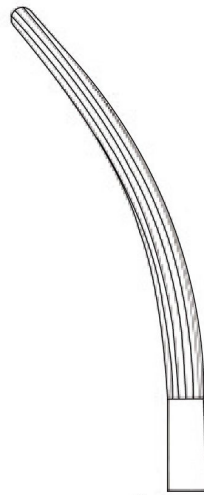

B04-287-24
 24,5 cm / 9 5/8"

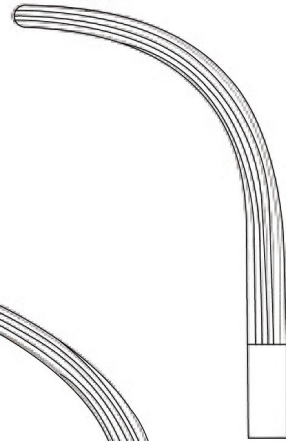

2

Dissecting and Ligature Forceps
 Präparierklemmen
 Pinzas para preparación y ligadura
 Pinces à disséquer et à ligatures
 Pinze per preparazioni e legature

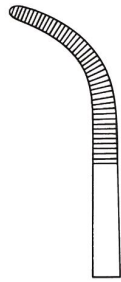

Fig. 1
B04-288-20
 20,5 cm / 8 1/8"

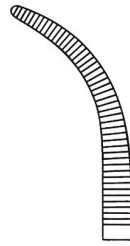

Fig. 2
B04-289-20
 20 cm / 7 7/8"



Fig. 3
B04-290-21
 21,5 cm / 8 4/8"

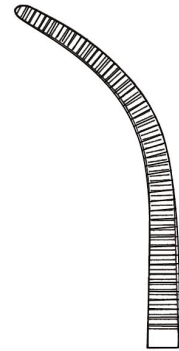

Fig. 4
B04-291-22
 22 cm / 8 5/8"

B04-288-27
 27 cm / 10 5/8"

B04-289-26
 26,5 cm / 10 3/8"

B04-290-27
 27,5 cm / 10 7/8"

B04-291-28
 28 cm / 11"



1/2

Overholt-Geissendörfer
B04-288-20
B04-294-27

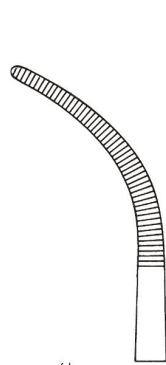

Fig. 5
B04-292-21
 21,5 cm / 8 4/8"

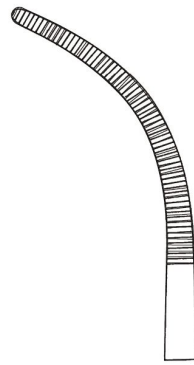

Fig. 6
B04-293-21
 21,5 cm / 8 3/8"



Fig. 7
B04-294-22
 22 cm / 8 5/8"

B04-292-27
 27,5 cm / 10 7/8"

B04-293-28
 28 cm / 11"

B04-294-27
 27,5 cm / 10 7/8"

Dissecting and Ligature Forceps
 Präparierklemmen
 Pinzas para preparación y ligadura
 Pincès à disséquer et à ligatures
 Pinze per preparazioni e legature

finoLine



1/2

Overholt-Fino
 B04-295-21
 B04-299-22



B04-295-21
 21,5 cm / 8 1/2"

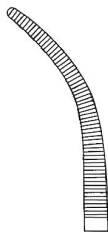

B04-296-22
 22 cm / 8 5/8"

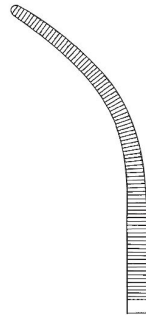

B04-297-22
 22,5 cm / 8 7/8"

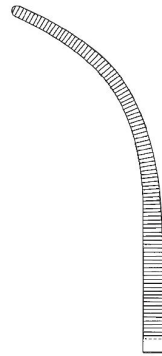

B04-298-23
 23 cm / 9"

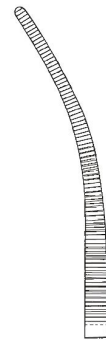

B04-299-22
 22,5 cm / 8 7/8"



Dissecting and Ligature Forceps
 Präparierklemmen
 Pinzas para preparación y ligadura
 Pincès à disséquer et à ligatures
 Pinze per preparazioni e legature

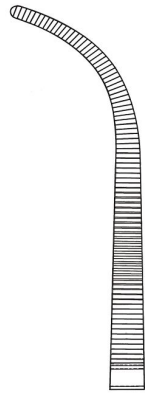

B04-300-29
 29,5 cm / 11 5/8"

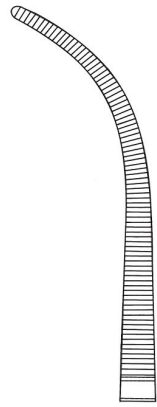

B04-301-29
 29,5 cm / 11 5/8"

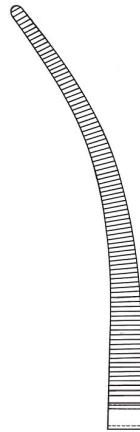

B04-302-30
 30 cm / 11 7/8"



1/2

Overholt
B04-300-29
B04-302-30

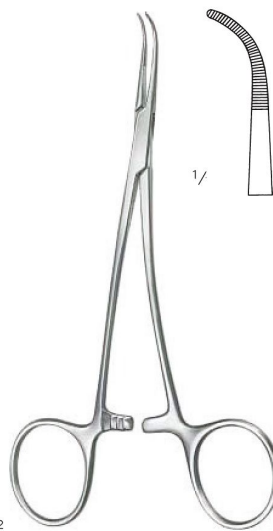

1/2

Overholt-Mini
B04-303-15
 15 cm / 5 7/8"



1/2

Overholt-Mini
B04-304-20
 20 cm / 7 7/8"

Dissecting and Ligature Forceps
 Präparierklemmen
 Pinzas para preparación y ligadura
 Pincès à disséquer et à ligatures
 Pinze per preparazioni e legature



1/2

Gemini
 B04-305-13
 B04-305-28



1/2

Mini-Gemini
 B04-306-18
 B04-306-28

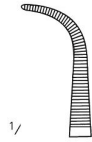

1/1

B04-305-13
 13 cm / 5 1/8"

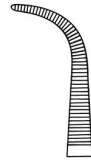

B04-305-16
 16 cm / 6 2/8"



B04-305-18
 18 cm / 7 1/8"



B04-305-21
 21 cm / 8 2/8"



B04-305-23
 23 cm / 9"



B04-305-25
 25 cm / 9 7/8"



B04-305-28
 28 cm / 11"



1/1

B04-306-18
 18 cm / 7 1/8"



B04-306-23
 23 cm / 9"



B04-306-25
 25 cm / 9 7/8"



B04-306-28
 28,5 cm / 11 2/8"





1/2

Rumel
B04-307-24
B04-311-24

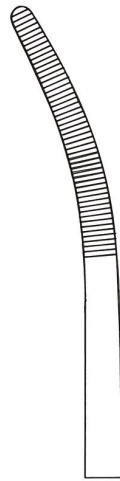

Fig. 1
B04-307-24
 24 cm / 9 4/8"

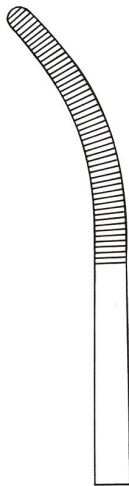

Fig. 2
B04-308-24
 24 cm / 9 4/8"

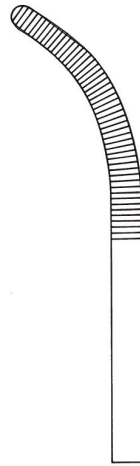

Fig. 3
B04-309-23
 23,5 cm / 9 2/8"

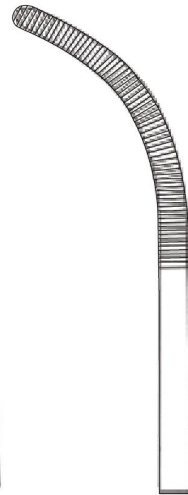

Fig. 4
B04-310-24
 24 cm / 9 4/8"

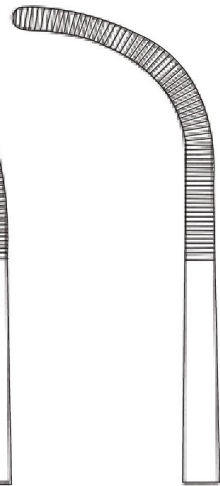
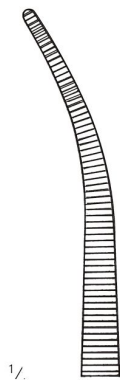

Fig. 5
B04-311-24
 24 cm / 9 4/8"

Dissecting and Ligature Forceps
 Präparierklemmen
 Pinzas para preparación y ligadura
 Pincès à disséquer et à ligatures
 Pinze per preparazioni e legature



1/2

B04-312-29
 29,5 cm / 11 5/8"

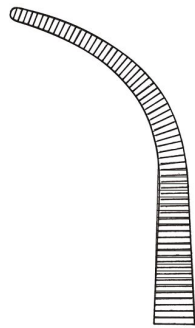

B04-312-28
 28,5 cm / 11 2/8"



1/2

Zenker
 B04-312-29
 B04-312-28



1/2

Mixer-Baby
 B04-313-13
 13 cm / 5 1/8"

Dissecting and Ligature Forceps
 Präparierklemmen
 Pinzas para preparación y ligadura
 Pincès à disséquer et à ligatures
 Pinze per preparazioni e legature

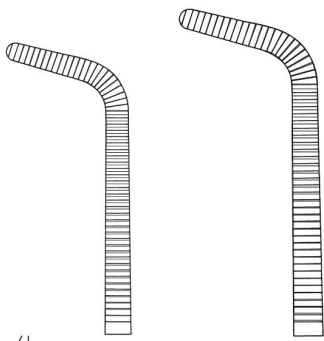

B04-314-16
 16 cm / 6 2/8"

B04-314-17
 17,5 cm / 6 7/8"



Mixer
 B04-314-16
 B04-314-17



O'Shaughnessy
 B04-315-15
 B04-320-26

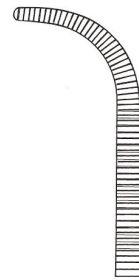

B04-315-15
 15 cm / 5 7/8"

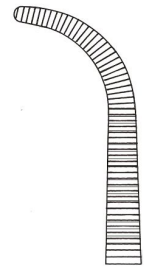

B04-316-18
 18 cm / 7 1/8"



B04-317-18
 18,5 cm / 7 2/8"



B04-318-20
 20 cm / 7 7/8"

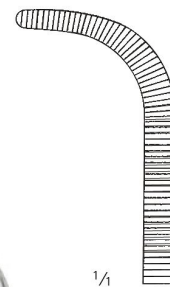

B04-319-23
 23 cm / 9"

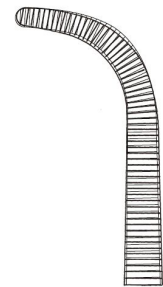

BC04-320-26
 26 cm / 10 2/8"

Dissecting and Ligature Forceps
 Präparierklemmen
 Pinzas para preparación y ligadura
 Pincas à disséquer et à ligatures
 Pinze per preparazioni e legature



Mixer
B04-321-22
 22,5 cm / 8 ⁷/₈"



Mixer
B04-322-23
 23 cm / 9"



B04-323-21
 21 cm / 8 ²/₈"

B04-323-24
 24,5 cm / 9 ⁵/₈"



Dissecting and Ligature Forceps
Präparierklemmen
Pinzas para preparación y ligadura
Pincès à disséquer et à ligatures
Pinze per preparazioni e legature



Mixer
B04-324-22
B04-324-28

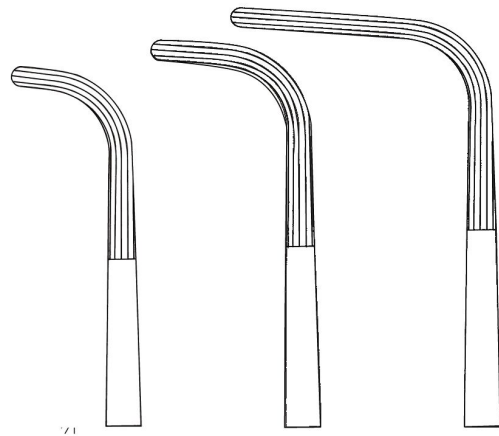

B04-324-22
22,5 cm / 8 5/8"

B04-324-26
26 cm / 10 1/8"

B04-324-28
28 cm / 11"

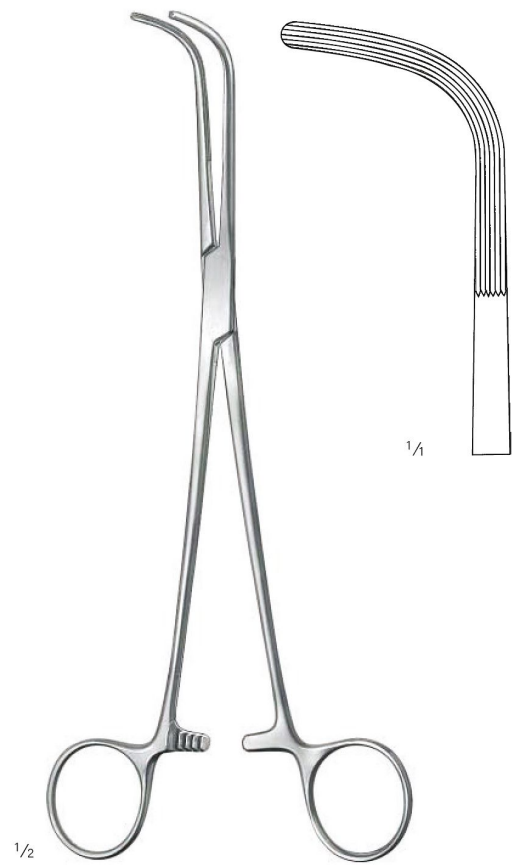

McQuigg-Mixer
B04-325-23
23,5 cm / 9 1/8"

Bile Duct Clamps, Dissecting and Ligature Forceps

Gallenkanalklemmen, Präparierklemmen

Pinzas para conducto biliar, Pinzas para preparación y ligadura

Pinces pour les voies biliaires, Pinces à disséquer et à ligatures

Pinze per vie biliari, Pinze per preparazioni e legature

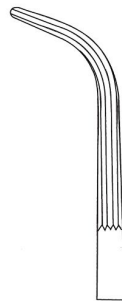

B04-327-19
19,5 cm / 7 5/8"

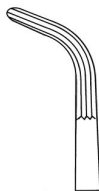

1/2

Lower
B04-326-18
18,5 cm / 7 1/4"

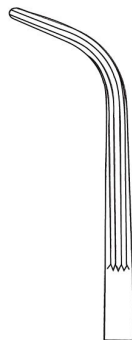

1/2

Lahey
B04-327-19
B04-327-22

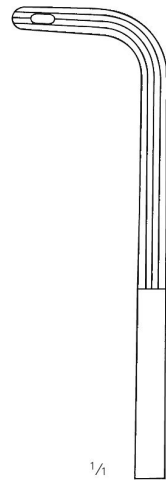

1/2

Finochietto
B04-328-24
24,5 cm / 9 5/8"



Tangential Forceps, Kidney Pedicle Clamps

Tangentialklemmen, Nierenstiellklemmen
Pinzas tangenciales, Pinzas para pedículo renal
Pincés tangentièlles, Pince-clamps pour pédicules rénaux
Pinze tangenziali, Pinze per peduncoli renali



Atrauma

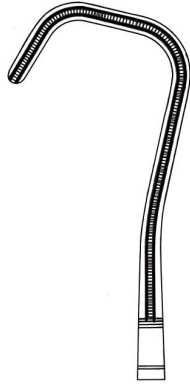
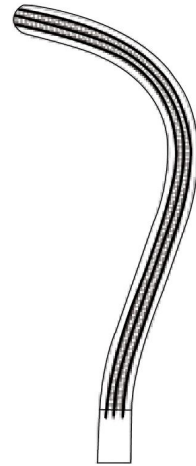

Fig. 1
B04-329-25
25 cm / 9 7/8"



B04-330-23
23 cm / 9"

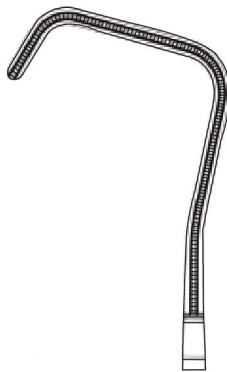
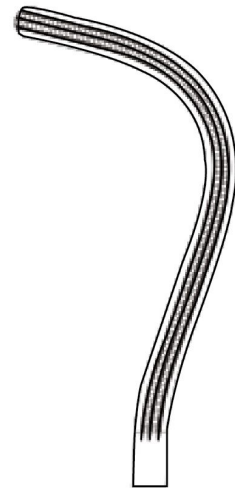

Fig. 2
B04-329-26
26 cm / 10 2/8"



B04-330-24
24 cm / 9 4/8"



1/2

Uro-Tangential
B04-329-25
B04-329-26



1/2

Guyon
B04-330-23
B04-330-24

Kidney Pedicle Clamps

Nierenstielklemmen
Pinzas para pedículo renal
Pince-clamps pour pédicules rénaux
Pinze per peduncoli renali

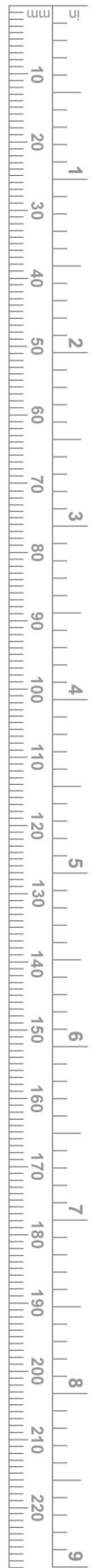

1/2

Guyon
B04-331-19
B04-331-24

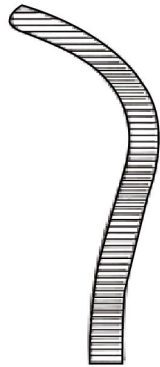

B04-331-19
19,5 cm / 7 5/8"

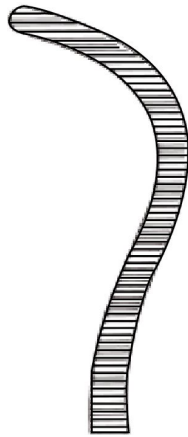

B04-331-21
21,5 cm / 8 1/2"

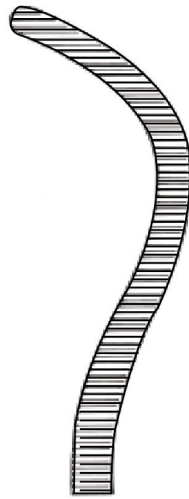

B04-331-24
24,5 cm / 9 5/8"



1/2

Guyon
B04-332-24
24 cm / 9 1/2"

1/2

Bile Duct Clamps

Gallenkanalklemmen
Pinzas para conducto biliar
Pincas pour les voies biliaires
Pinze per vie biliari



Desjardins

B04-333-21

21 cm / 8 2/6"

Dissecting and Ligature Forceps
 Präparierklemmen
 Pinzas para preparación y ligadura
 Pincès à disséquer et à ligatures
 Pinze per preparazioni e legature

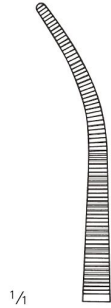

Fig. 1
B04-334-19
 19 cm / 7 4/8"



Fig. 1
B04-334-22
 22,5 cm / 8 7/8"



Fig. 1
B04-334-23
 23 cm / 9"

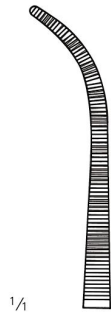

Fig. 2
B04-335-19
 19 cm / 7 4/8"



Fig. 2
B04-335-22
 22 cm / 8 5/8"



Fig. 2
B04-335-23
 23,5 cm / 9 2/8"

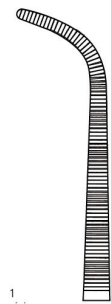

Fig. 3
B04-336-18
 18,5 cm / 7 3/8"



Fig. 3
B04-336-21
 21,5 cm / 8 4/8"



Fig. 3
B04-336-23
 23 cm / 9"



1/2

Kelly
B04-334-19
B04-336-23



Dissecting and Ligature Forceps, Haemostatic Forceps
 Präparierklemmen, Arterienklemmen
 Pinzas para preparación y ligadura, Pinzas hemostáticas
 Pinces à disséquer et à ligatures, Pinces hémostatiques
 Pinze per preparazioni e legature, Pinze emostatiche



1/2

Lawrence
B04-337-28
 28 cm / 11"



1/2

Meeker
B04-338-28
 28 cm / 11"



1/2

Negus
B04-339-19
B04-339-20

Fig. 1

B04-339-19
 19,5 cm / 7 5/8"

Fig. 2

B04-339-20
 20 cm / 7 7/8"



B04-340-20
 20,5 cm / 8 1/8"

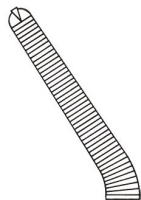

B04-341-20
 20 cm / 7 7/8"



Phaneuf
 B04-340-20
 B04-341-20



Heaney
 B04-342-19
 B04-343-24



Fig. 1
B04-342-19
 19,5 cm / 7 5/8"



Fig. 1
B04-342-21
 21,5 cm / 8 4/8"



Fig. 1
B04-342-24
 24 cm / 9 4/8"



Fig. 2
B04-343-19
 19,5 cm / 7 5/8"



Fig. 2
B04-343-21
 21,5 cm / 8 4/8"



Fig. 2
B04-343-24
 24 cm / 9 4/8"

Vaginal Clamp
Vaginalklemmen
Pinzas vaginal
Pinces vaginales
Pinza vaginale



1/2

Wertheim-Cullen

B04-344-21

21 cm / 8 2/8"



Hysterectomy Forceps
 Hysterektomieklemmen
 Pinzas para histerectomía
 Pincas à hystérectomie
 Pinze per isterectomia

Atrauma

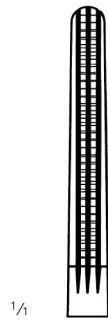

1/4

Fig. 1
B04-345-21
 21,5 cm / 8 4/8"



Fig. 2
B04-346-21
 21 cm / 8 2/8"



Fig. 3
B04-347-21
 21 cm / 8 2/8"

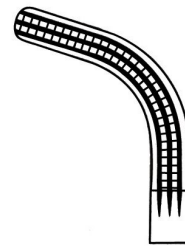
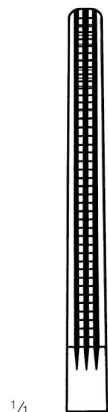

Fig. 4
B04-348-20
 20,5 cm / 8 1/8"



1/4

Fig. 1
B04-349-25
 25,5 cm / 10"

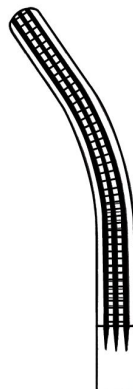

Fig. 2
B04-350-25
 25 cm / 9 7/8"

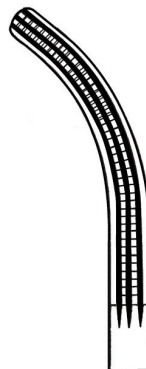

Fig. 3
B04-351-24
 24,5 cm / 9 4/8"

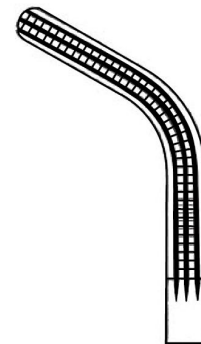
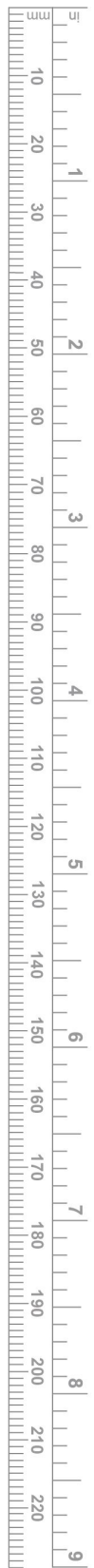

Fig. 4
B04-352-24
 24,5 cm / 9 4/8"



1/2

Rogers
B04-345-21
B04-352-24



Bile Duct Clamps

Gallenkanalklemmen
Pinzas para conducto biliar
Pinces pour les voies biliaires
Pinze per vie biliari



Moynihan
B04-353-23
23 cm / 9"



Moynihan
B04-354-23
23,5 cm / 9 2/8"



Hysterectomy Forceps
 Hysterektomieklemmen
 Pinzas para histerectomía
 Pinces à hystérectomie
 Pinze per isterectomia



Wertheim
B04-355-26
 26 cm / 10 2/8"



Wertheim
B04-356-22
B04-357-22
 22,5 cm / 8 7/8"



B04-356-22



leicht gebogen
 slightly curved
 curva ligera
 courbe légère
 curva leggera



B04-357-22



stärker gebogen
 stronger curved
 curva fuerte
 courbe forte
 curva forte

Peritoneum Forceps
 Peritoneumklemmen
 Pinzas para peritoneo
 Pince pour le péritoine
 Pinze per peritoneo



Mikulicz-Baby
B04-358-14
 14,5 cm / 5 9/16"



Mikulicz
B04-359-18
 18,5 cm / 7 3/8"



Mikulicz
B04-360-20
 20 cm / 7 7/8"

Peritoneum Forceps
 Peritoneumklemmen
 Pinzas para peritoneo
 Pince pour le péritoine
 Pinze per peritoneo

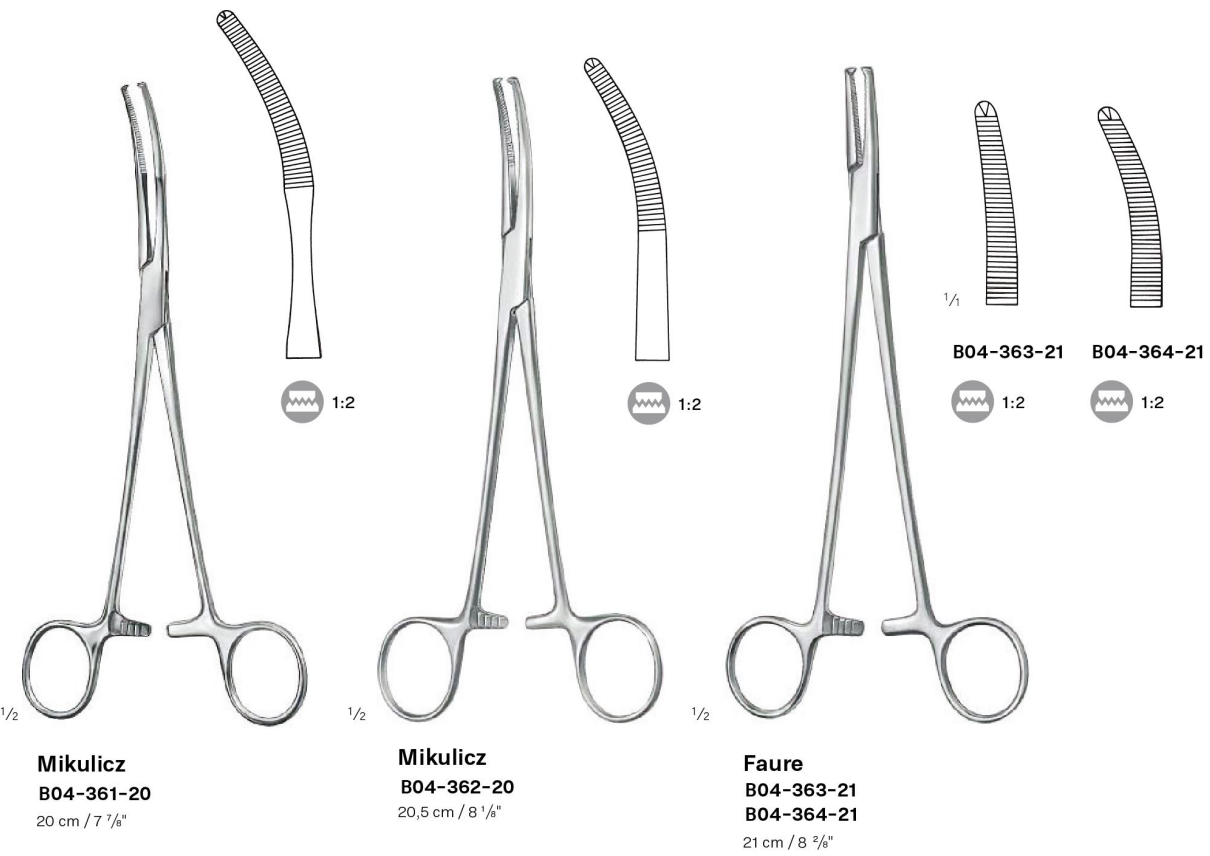

Towel Clamps

Tuchklemmen
Pinzas de campo
Pinces à champs
Pinze fissatele



1/2

Schädel

B04-365-09

9 cm / 3 4/8"

scharf
sharp
agudo
pointu
acuto



1/2

Jones

B04-366-05

B04-366-08

scharf
sharp
agudo
pointu
acuto

B04-366-05

5,5 cm / 2 1/8"

B04-366-08

8,5 cm / 3 3/8"



1/2

Jones-Martin

B04-367-08

8,5 cm / 3 3/8"

scharf, mit Schlauchhalter
sharp, with tube holder
agudo, con porta-tubo
pointu, avec clamp porte-tube
acuto, con porta-tubo



1/2

Backhaus

B04-368-11

B04-368-13

graziles Modell, scharf
delicate model, sharp
modelo delicado, aguda
modèle gracile, aiguë
modello delicato, acuto

B04-368-11

11 cm / 4 3/8"

B04-368-13

13 cm / 5 1/8"



1/2

Backhaus

B04-370-09

B04-370-11

B04-370-13

B04-370-16

scharf
sharp
agudo
pointu
acuto



B04-370-09

9 cm / 3 4/8"

B04-370-11

11 cm / 4 3/8"

B04-370-13

13 cm / 5 1/8"

B04-370-16

16 cm / 6 2/8"

Towel Clamps
Tuchklemmen
Pinzas de campo
Pinces à champs
Pinze fissatele



Peers-Bertram modif.
B04-371-14

14,5 cm / 5 9/16"

weites Maul zur Schlauchfixierung
wide jaw for tube fixation
boca ancha para fijación de tubos
mors large pour fixation de tube
morso spalancato per fissare il tubo



Roeder
B04-372-13

13,5 cm / 5 3/8"



Lorna
B04-373-10
B04-373-13

fein gezahnt, breites Maul
fine serration, wide jaw
delicadamente dentada, boca ancha
avec dents fins, mors large
con denti fini, morso largo

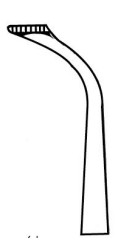

B04-373-10
10 cm / 3 7/8"

B04-373-13
13 cm / 5 1/8"



Bernhard
B04-374-16

16,5 cm / 6 4/8"

scharf
sharp
agudo
pointu
acuto

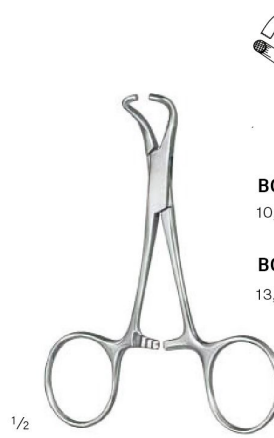

Tohoku
B04-375-10
B04-375-13

stumpf
blunt
romo
mousse



B04-375-10
10,5 cm / 4 1/8"

B04-375-13
13,5 cm / 5 3/8"

Towel Clamps, Tubing Clamps

Tuchklemmen, Schlauchklemmen
Pinzas de campo, Pinzas para tubos
Pincas à champs, Pincas presse-tubes
Pinze fissatele, Pinze serratubi

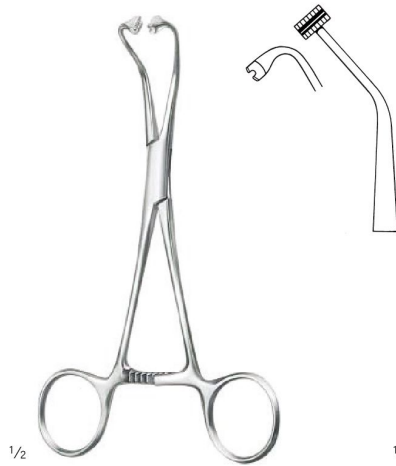

Peers-Bertram

B04-376-14

14,5 cm / 5 5/8"

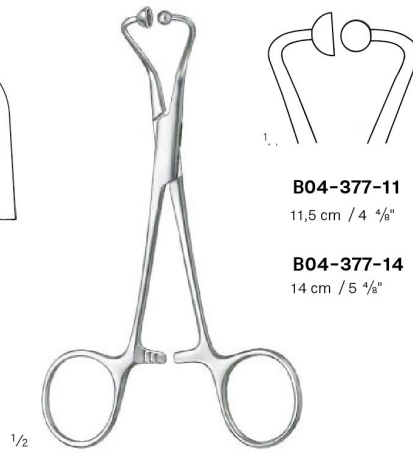

B04-377-11

11,5 cm / 4 5/8"

B04-377-14

14 cm / 5 1/2"



Lane

B04-378-19

19,5 cm / 7 5/8"

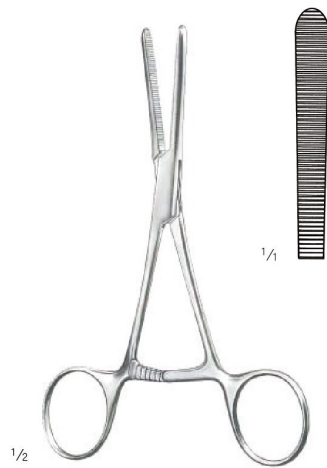

B04-379-14

14 cm / 5 1/2"

extra lange Sperre
extra long ratchet
cremallera extra larga
cremallère extrêmement longue
cremagliera stralunga

B04-377-11
B04-377-14

für Papierabdeckung
for paper drapes
para paños de papel
pour couverture en papier
per copertura di carta

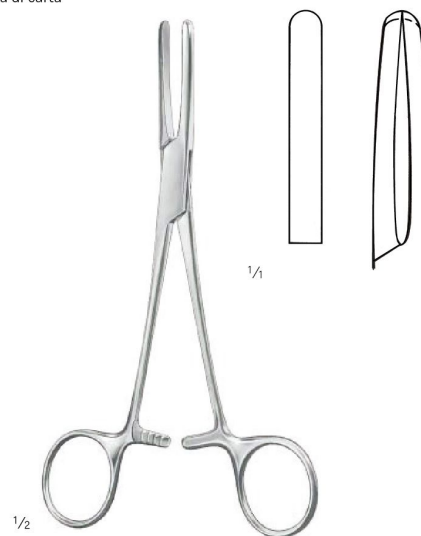

B04-380-16

16,5 cm / 6 1/2"

glattes Maul
smooth jaw
boca lisa
mors lisse
morso liscio

Tubing Clamps

Schlauchklemmen
Pinzas para tubos
Pinces presse-tubes
Pinze serratubi



B04-381-15
B04-381-20

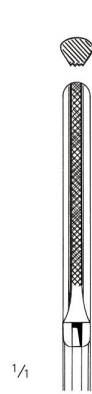

B04-381-15
15,5 cm / 6 1/8"



B04-381-19
19 cm / 7 4/8"



B04-381-20
20,5 cm / 8 1/8"



B04-382-19
B04-382-20
mit Schutzbügel
with safety guard
con sbrido de protección
avec protection
con protezione

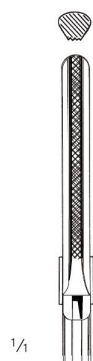

B04-382-15
15,5 cm / 6 1/8"

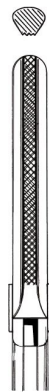

B04-382-19
19 cm / 7 4/8"

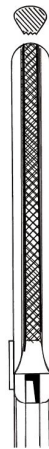

B04-382-20
20,5 cm / 8 1/8"

Tubing Clamps

Schlauchklemmen
Pinzas para tubos
Pincas presse-tubes
Pinze serratubi



1/2

Gunnar-Hey

B04-384-18

18 cm / 7 1/8"



no one does it BETTER



Cell: 0092 323 9300123

Tel: 0092 52 3563378

URL: <https://bona-dent.com>

Email: info@bona-dent.com

Email: bonadent.mfg@gmail.com

Address:

Kacha Shahab Pura Road

Jeewan Pura, Sialkot (51310)

Pakistan.

