

IMPROVED DURABILITY

• HIGH STRENGTH
AND ENHANCED
TECHNOLOGY



CARDIO +
VASCULAR



An Era Of **evolution**

Bonadent

HAS THE REPUTATION OF BEING THE ONLY IN PAKISTAN THAT MANUFACTURES ITS OWN TOOLS FOR THE PRODUCTION OF ITS INSTRUMENTS.

Bonadent is a privately owned company providing personalized services and the finest in Surgical Instruments for over 25 years. Established in 1999, Our Company manufactures a wide range of Surgical, Dental and Veterinary Instruments.

All Instruments and devices of our product range are manufactured by well-trained and experienced skilled workers with special craftsmanship and by use of most modern machines and equipment. On this occasion we only use materials which meet our high standards. The CEO of Bonadent Manufacturing co, Mr. Muhammad Ibrahim brings with him a lifetime of knowledge about the world of surgical instruments.

This insight allows us to understand the needs of our customers in a way most other instrument companies are unable to do.

After becoming a competent oem service provider, cardiac has decided to introduce itself as the original source of high quality instrumentation to directly interact with some of the well-known brands around the world.

Rib Shears
Rippenscheren
Costótomos
Costotomes
Costotomi



13



1/2

B13-100-23
23 cm / 9"
Knochenschere
Bone Shears
Cizallas para hueso
Cisailles à os
Cesoia per ossa



1/2

B13-101-23
23 cm / 9"



1/2

Gluck
B13-102-21
21 cm / 8 3/8"

ziehender Schnitt
drawing cut
corte oblicuo
lame glissante
lama di retroazione



13

Rib Shears
Rippenscheren
Costótomos
Costotomes
Costotomi



1/2

Bethune
B13-103-34
34,5 cm / 13 5/8"



1/2

Sauerbruch
B13-104-26
26 cm / 10 1/8"



1/2

Giertz-Stille
B13-105-24
24,5 cm / 9 5/8"



01



02



Rib Shears, Sternum Chisel
 Rippenscheren, Sternummeißel
 Costotomos, Cincel para esternón
 Costotomes, Ciseau-burin à sternum
 Costotomi, Scalpello per sterno



13

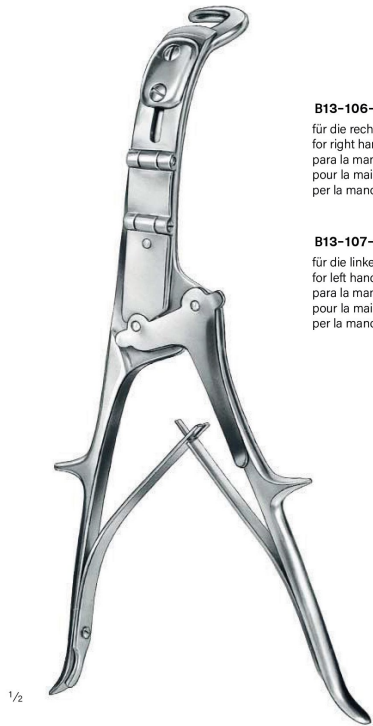

1/2
Brunner
B13-106-32
B13-107-32
 32 cm / 12 5/8"

B13-106-32
 für die rechte Hand
 for right hand
 para la mano derecha
 pour la main droite
 per la mano destra

B13-107-32
 für die linke Hand
 for left hand
 para la mano izquierda
 pour la main gauche
 per la mano sinistra



1/2
Lebsche
B13-108-24
 24,5 cm / 9 5/8"

Aortic Punches, Chest Tube Passer
 Aortenstanzen, Drainagedurchführungen
 Perforadores aórticos, Pinza de drenaje
 Rongeurs pour aorte, Pince de drainage
 Pinze taglianti per aorta, Pinze drenaggio



13



1/2

B13-109-01
B13-109-06
 15 cm / 5 7/8"
 Aortenstanzen
 Aortic punches
 Perforadore aórticos
 Rongeur pour aorte
 Pinza tagliante per aorta



	Ø
B13-109-01	3,0 mm
B13-109-02	3,5 mm
B13-109-03	4,0 mm
B13-109-04	4,5 mm
B13-109-05	5,0 mm
B13-109-06	6,0 mm

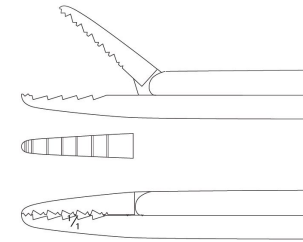

1/2

B13-110-24
B13-111-34

	ohne Sperre w/o ratchet sin trinquete sans cran d'arrêt senza arresto	mit Sperre with ratchet con trinquete avec cran d'arrêt con arresto
24 cm / 9 3/8"	B13-110-24	B13-111-24
34 cm / 13 3/8"	B13-110-34	B13-111-34



Sternum and Rib Retractors
 Sternum- und Rippensperrer
 Separadores esternales y costales
 Écarteurs à sternum et des côtes
 Divaricatori per sterno e costali



13



B13-112-02
9 x 20 mm

B13-112-03
9 x 10 mm



B13-112-01
B13-112-03

Ti			
für Säuglinge for babies para recién nacidos pour nourissons per neonati			
	a x b	c	d
B13-112-02	9 x 20 mm	40 mm	52 mm
B13-112-03	9 x 10 mm		
B13-112-01			
2 Paar Valven (24-159-02-09/-03-09) und Rahmen 2 pairs of blades (24-159-02-09/-03-09) and frame 2 pares de valvas (24-159-02-09/-03-09) y bastidor 2 paires de valves (24-159-02-09/-03-09) et cadre 2 coppie di valve (24-159-02-09/-03-09) e telaio			
B13-112-02			
B13-112-03			



Cooley
B13-113-01
B13-113-02

Al			
für Säuglinge for babies para recién nacidos pour nourissons per neonati			
	a x b	c	d
B13-113-01	12 x 16 mm	60 mm	95 mm
für Kinder for children para niños pour enfants per bambini			
	a x b	c	d
B13-113-02	15 x 30 mm	80 mm	95 mm

Sternum and Rib Retractors
 Sternum- und Rippensperrer
 Separadores esternales y costales
 Écarteurs à sternum et des côtes
 Divaricatori per sterno e costali



13



1/2
Cooley
B13-113-03
B13-113-06

Al St			
für Kinder for children para niños pour enfants per bambini			
	a x b	c	d
B13-113-03	20 x 45 mm	100 mm	150 mm
für Erwachsene for adults para adultos pour adultes per adulti			
	a x b	c	d
B13-113-04	35 x 50 mm	140 mm	180 mm
B13-113-05	30 x 105 mm	160 mm	195 mm
B13-113-06	30 x 105 mm	160 mm	195 mm



1/2
Finochietto
B13-114-01
B13-114-02

Al			
für Säuglinge for babies para recién nacidos pour nourissons per neonati			
	a x b	c	d
B13-114-01	15 x 15 mm	60 mm	75 mm
für Kinder for children para niños pour enfants per bambini			
	a x b	c	d
B13-114-02	31 x 31 mm	80 mm	100 mm



Sternum and Rib Retractors
 Sternum- und Rippensperrer
 Separadores esternales y costales
 Écarteurs à sternum et des côtes
 Divaricatori per sterno e costali



13



AI

für Kinder und Erwachsene
 for children and adults
 para niños y adultos
 pour enfants et adultes
 per bambini e adulti

	a x b	c	d
B13-115-01	40 x 45 mm	105 mm	135 mm
B13-115-02	45 x 60 mm	140 mm	175 mm
B13-115-03	85 x 65 mm	140 mm	175 mm

1/2
 Finochietto
 B13-115-01
 B13-115-03

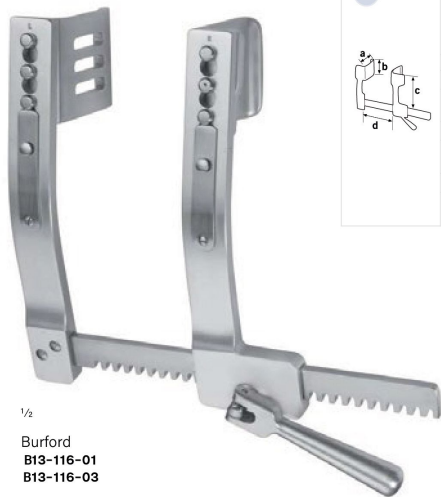

AI

für Erwachsene
 for adults
 para adultos
 pour adultes
 per adulti

	a x b	c	d
B13-116-01	47 x 62 mm 62 x 62 mm	195 mm	165 mm
B13-116-02	47 x 62 mm 62 x 62 mm	195 mm	260 mm
B13-116-03	47 x 62 mm 62 x 62 mm	195 mm	280 mm

1/2
 Burford
 B13-116-01
 B13-116-03



Sternum and Rib Retractors
 Sternum- und Rippensperrer
 Separadores esternales y costales
 Écarteurs à sternum et des côtes
 Divaricatori per sterno e costali



13



1/2
 Castañeda
 B13-117-01
 B13-117-03

AI

für Säuglinge
 for babies
 para recién nacidos
 pour nourissons
 per neonati

	a x b	c	d
B13-117-01	10 x 32 mm	60 mm	65 mm

für Säuglinge und Kinder
 for babies and children
 para recién nacidos y niños
 pour nourissons et enfants
 per neonati e bambini

	a x b	c	d
B13-117-02	12 x 45 mm	80 mm	70 mm

für Kinder
 for children
 para niños
 pour enfants
 per bambini

	a x b	c	d
B13-117-03	15 x 60 mm	120 mm	105 mm



1/2
 Finochietto (modif.)
 B13-118-01

AI

für Kinder und Erwachsene
 for children and adults
 para niños y adultos
 pour enfants et adultes
 per bambini e adulti

	a x b	c	d
B13-118-01	14 x 15 mm	100 mm	100 mm



Sternum and Rib Retractors
 Sternum- und Rippensperrer
 Separadores esternales y costales
 Écarteurs à sternum et des côtes
 Divaricatori per sterno e costali



13



1/2

Haight
 B13-119-90

St		für Kinder und Erwachsene for children and adults para niños y adultos pour enfants et adultes per bambini e adulti			
		a x b	c	d	
		B13-119-90	30 x 30 mm	90 mm	120 mm

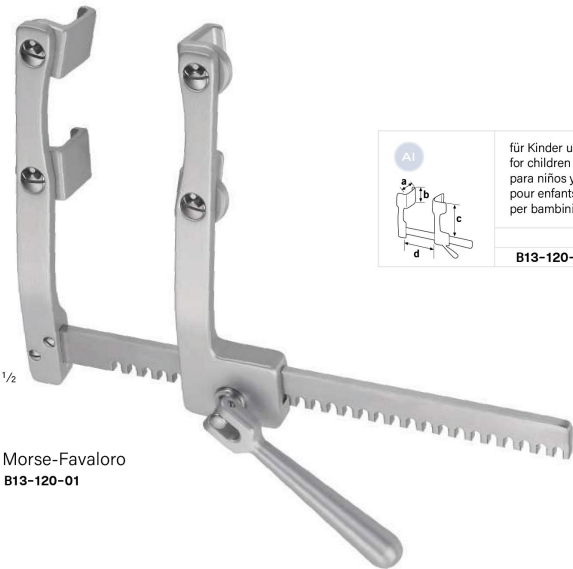

1/2

Morse-Favaloro
 B13-120-01

Al		für Kinder und Erwachsene for children and adults para niños y adultos pour enfants et adultes per bambini e adulti			
		a x b	c	d	
		B13-120-01	17 x 22 mm	120 mm	160 mm

Sternum and Rib Retractors
 Sternum- und Rippensperrer
 Separadores esternales y costales
 Écarteurs à sternum et des côtes
 Divaricatori per sterno e costali



13

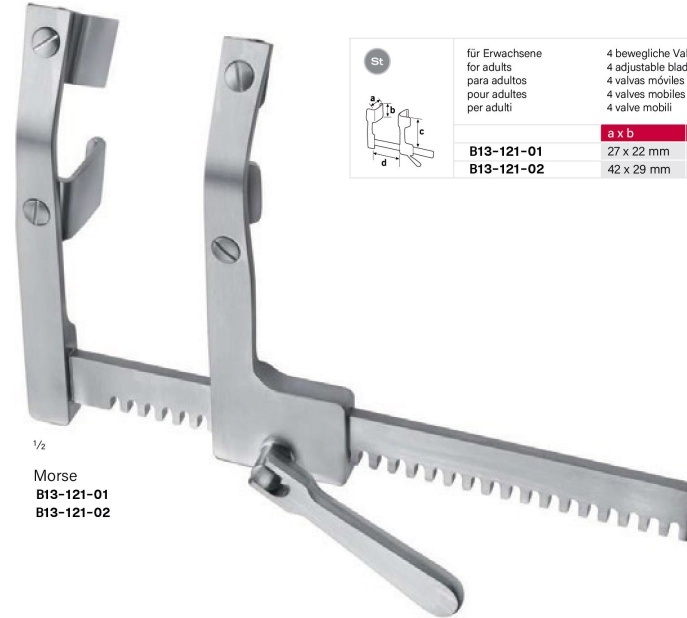

1/2

Morse
 B13-121-01
 B13-121-02

St		für Erwachsene for adults para adultos pour adultes per adulti			
		a x b	c	d	
		B13-121-01	27 x 22 mm	145 mm	200 mm
		B13-121-02	42 x 29 mm	140 mm	210 mm



1/2

Tuffier
 B13-122-01

St		für Erwachsene for adults para adultos pour adultes per adulti			
		a x b	c	d	
		B13-122-01	45 x 45 mm	110 mm	170 mm



Sternum and Rib Retractors
 Sternum- und Rippensperrer
 Separadores esternales y costales
 Écarteurs à sternum et des côtes
 Divaricatori per sterno e costali



13

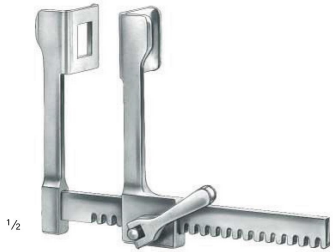

Finochietto, Baby
 B13-123-01

für Säuglinge und Kinder for babies and children para recién nacidos y niños pour nourissons et enfants per neonati e bambini				
	a x b	c	d	
B13-123-01	15 x 20 mm	50 mm	75 mm	

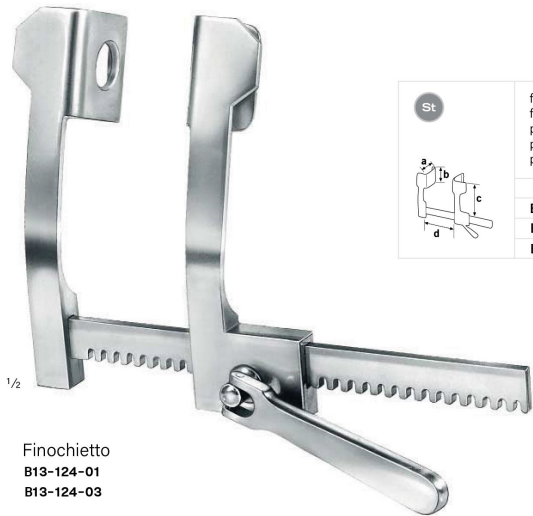

Finochietto
 B13-124-01
 B13-124-03

für Erwachsene for adults para adultos pour adultes per adulti				
	a x b	c	d	
B13-124-01	40 x 45 mm	110 mm	150 mm	
B13-124-02	45 x 65 mm	140 mm	165 mm	
B13-124-03	80 x 65 mm	140 mm	190 mm	

11

Sternum and Rib Retractors
 Sternum- und Rippensperrer
 Separadores esternales y costales
 Écarteurs à sternum et des côtes
 Divaricatori per sterno e costali



13

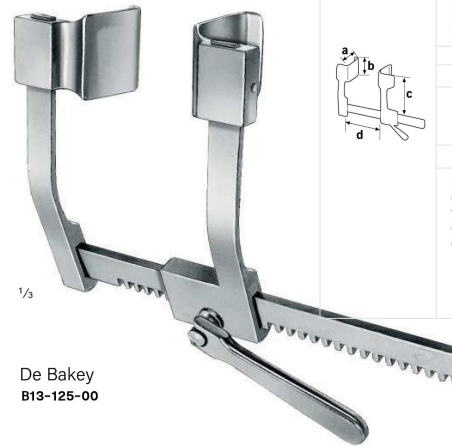

De Bakey
 B13-125-00

für Erwachsene for adults para adultos pour adultes per adulti				
	a x b	c	d	
B13-125-00	30 x 30 mm 40 x 40 mm 50 x 50 mm	160 mm	150 mm	
bestehend aus consisting of formado por composé de consistente in	3 Paar Valven 3 pairs of blades 3 pares de valvas 3 paires de valves 3 coppie di valve	Rahmen Frame Bastidor Cadre Telaio		
B13-125-02 B13-125-03 B13-125-04			B13-125-01	



De Bakey
 B13-125-02
 30 x 30 mm



De Bakey
 B13-125-03
 40 x 40 mm



De Bakey
 B13-125-04
 50 x 50 mm



12

Sternum and Rib Retractors
 Sternum- und Rippensperrer
 Separadores esternales y costales
 Écarteurs à sternum et des côtes
 Divaricatori per sterno e costali



13

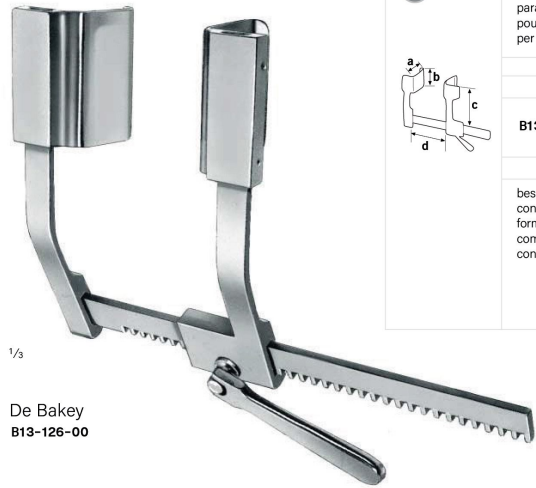

De Bakey
B13-126-00

für Erwachsene for adults para adultos pour adultes per adulti		a x b	c	d
	B13-126-00	60 x 60 mm 50 x 80 mm 40 x 100 mm	170 mm	200 mm
	bestehend aus consisting of formado por composé de consistente in	3 Paar Valven 3 pairs of blades 3 pares de valvas 3 paires de valves 3 coppie di valve	Rahmen Frame Bastidor Cadre Telaio	
	B13-126-02 B13-126-03 B13-126-04		B13-126-01	



De Bakey
B13-126-02
60 x 60 mm



De Bakey
B13-126-03
50 x 80 mm



De Bakey
B13-126-04
40 x 100 mm



De Bakey
B13-126-05
80 x 60 mm



De Bakey
B13-126-06
50 x 65 mm

Sternum and Rib Retractors
 Sternum- und Rippensperrer
 Separadores esternales y costales
 Écarteurs à sternum et des côtes
 Divaricatori per sterno e costali



13

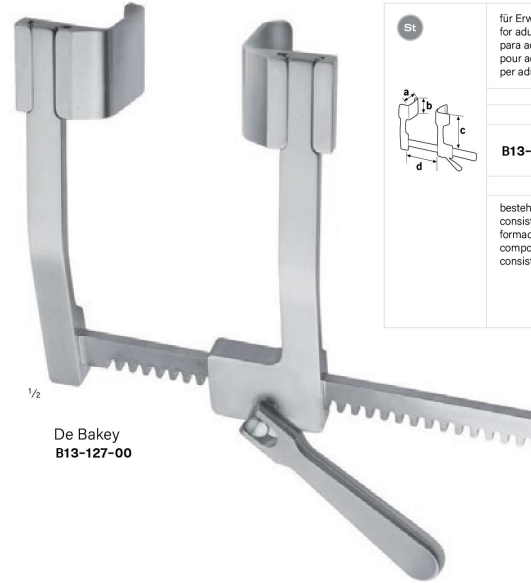

De Bakey
B13-127-00

für Erwachsene for adults para adultos pour adultes per adulti		a x b	c	d
	B13-127-00	30 x 30 mm 40 x 40 mm 40 x 40 mm	145 mm	150 mm
	bestehend aus consisting of formado por composé de consistente in	3 Paar Valven 3 pairs of blades 3 pares de valvas 3 paires de valves 3 coppie di valve	Rahmen Frame Bastidor Cadre Telaio	
	B13-127-02 B13-127-03 B13-127-04		B13-127-01	



De Bakey
B13-127-02
30 x 30 mm



De Bakey
B13-127-03
40 x 40 mm



De Bakey
B13-127-04
50 x 50 mm



Sternum and Rib Retractors
 Sternum- und Rippensperrer
 Separadores esternales y costales
 Écarteurs à sternum et des côtes
 Divaricatori per sterno e costali



13

	für Erwachsene for adults para adultos pour adultes per adulti			
		a x b	c	d
		60 x 60 mm		
		50 x 80 mm	190 mm	240 mm
		40 x 100 mm		
bestehend aus consisting of formado por composé de consistente in		3 Paar Valven 3 pairs of blades 3 pares de valvas 3 paires de valves 3 coppie di valve	Rahmen Frame Bastidor Cadre Telaio	
		B13-128-02	B13-128-01	
		B13-128-03		
		B13-128-04		

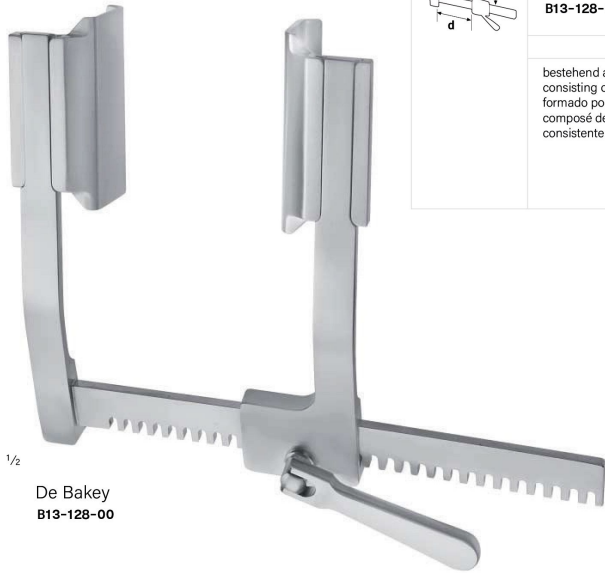

1/2
 De Bakey
 B13-128-00

Sternum and Rib Retractors
 Sternum- und Rippensperrer
 Separadores esternales y costales
 Écarteurs à sternum et des côtes
 Divaricatori per sterno e costali



13



1/2
 De Bakey
 B13-128-02
 60 x 60 mm



De Bakey
 B13-128-03
 50 x 80 mm



1/2
 De Bakey
 B13-128-04
 40 x 100 mm



De Bakey
 B13-128-05
 80 x 60 mm



1/2
 De Bakey
 B13-128-06
 50 x 65 mm



Sternum and Rib Retractors
 Sternum- und Rippensperrer
 Separadores esternales y costales
 Écarteurs à sternum et des côtes
 Divaricatori per sterno e costali

St	für Erwachsene for adults para adultos pour adultes per adulti			
		a x b	c	d
		30 x 100 mm	140 mm	160 mm
	B13-129-00	40 x 100 mm		
		50 x 100 mm		
bestehend aus consisting of formado por composé de consistente in	3 Paar Valven 3 pairs of blades 3 pares de valvas 3 paires de valves 3 coppie di valve	Rahmen Frame Bastidor Cadre Telaio		
	B13-129-03 B13-129-04 B13-129-05	B13-129-02		

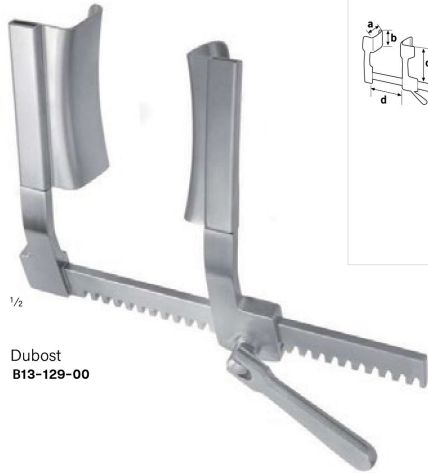

Dubost
B13-129-00

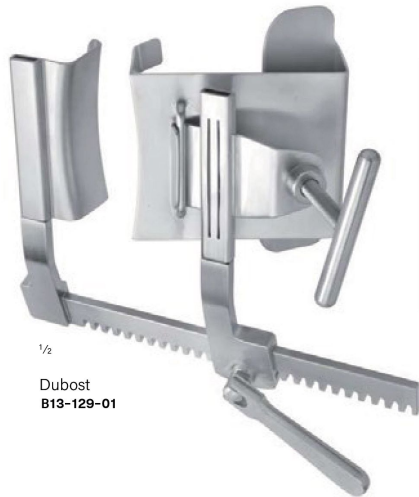

Dubost
B13-129-01

B13-129-01	IMA-Konfiguration IMA configuration Configuración IMA Configuration IMA Configurazione IMA	St	
bestehend aus consisting of formado por composé de consistente in	3 Paar Valven 3 pairs of blades 3 pares de valvas 3 paires de valves 3 coppie di valve	IMA-Valven IMA blades Valvas IMA Valves IMA Valve IMA	Rahmen Frame Bastidor Cadre Telaio
B13-129-03 B13-129-04 B13-129-05	B13-129-06 B13-129-07	B13-129-02	

Sternum and Rib Retractors
 Sternum- und Rippensperrer
 Separadores esternales y costales
 Écarteurs à sternum et des côtes
 Divaricatori per sterno e costali



Dubost
B13-129-03
30 x 100 mm



Dubost
B13-129-04
40 x 100 mm



Dubost
B13-129-05
50 x 100 mm



Dubost
B13-129-06
für IMA-Konfiguration
for IMA configuration
para configuración IMA
pour configuration IMA
per configurazione IMA



Dubost
B13-129-07
für IMA-Konfiguration
for IMA configuration
para configuración IMA
pour configuration IMA
per configurazione IMA



Sternum and Rib Retractors
 Sternum- und Rippensperrer
 Separadores esternales y costales
 Écarteurs à sternum et des côtes
 Divaricatori per sterno e costali



13

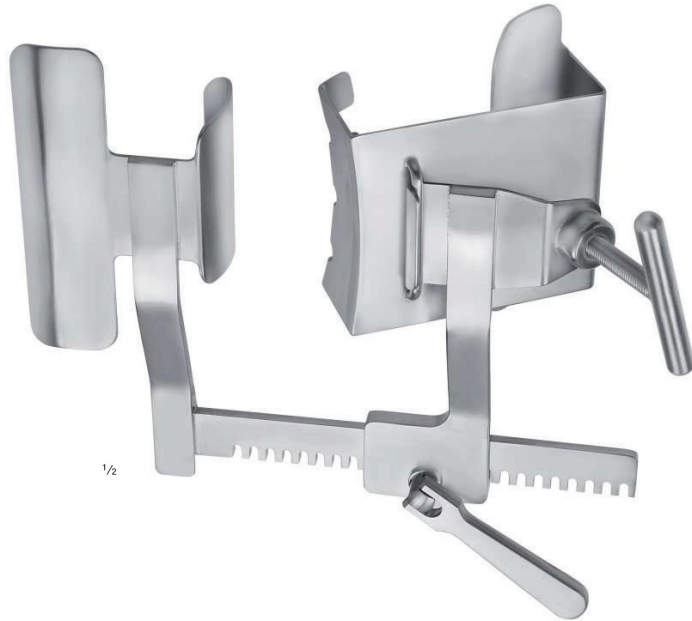

1/2

B13-130-00
 IMA-Sperrer
 IMA retractor
 Separador IMA
 Rétracteur IMA
 Divaricatore IMA

für Erwachsene
 for adults
 para adultos
 pour adultes
 per adulti

St				
	a x b	c	d	
 Starre Valve Starre blades Valves starr Valves starr Valve starr	50 x 80 mm	220 mm	130 mm	
IMA-Valven IMA blades Valves IMA Valves IMA Valve IMA	37 x 100 mm	220 mm	130 mm	

Sternum and Rib Retractors
 Sternum- und Rippensperrer
 Separadores esternales y costales
 Écarteurs à sternum et des côtes
 Divaricatori per sterno e costali



13



B13-131-00
 Mini-Thorakomie-Sperrer mit beweglichen Armen
 und abnehmbarer Querstange
 Mini thoracotomy retractor with adjustable, jointed arms
 and detachable bar
 Separador mini de toracotomía con brazos articulados
 y varilla transversal desmontable
 Écarteur mini-thoracotomie à bras mobiles
 et barre transversale amovible
 Divaricatore mini per toracotomia con bracci mobili
 e barra trasversale smontabile



exemplarische Klappenchirurgie-Konfiguration, bestehend aus
 exemplary valve surgery configuration, consisting of
 Configuración ejemplar de cirugía valvular, formado por
 exemple de configuration de chirurgie valvulaire, composé de
 Configurazione esemplare di chirurgia valvolare, composta da

Rahmen mit abnehmbare Querstange Frame with detachable bar Bastidor con varilla transversal desmontable Cadre avec barre transversale amovible Telaio con barra trasversale smontabile	1 Paar Valven 1 pairs of blades 1 pares de valvas 1 paires de valves 1 coppie di valve	Fixierelement Fixation element Elemento de fijación Élément de fixation Elemento di fissaggio	Haken Retractor Retractor Rétracteur Retratore
B13-131-01	B13-131-04	B13-134-02	B13-134-01

St				
	a x b	c	d	
 B13-131-00	40 x 36 mm 55 x 36 mm	100 mm	140 mm	
bestehend aus consisting of formado por composé de consistente in	2 Paar Valven 2 pairs of blades 2 pares de valvas 2 paires de valves 2 coppie di valve	Rahmen mit Querstange Bastidor con varilla transversal Cadre avec barre transversale Telaio con barra trasversale		
	B13-131-04 B13-131-05	B13-131-01		



Sternum and Rib Retractors
 Sternum- und Rippensperrer
 Separadores esternales y costales
 Écarteurs à sternum et des côtes
 Divaricatori per sterno e costali



13

Kein Gewinde, kein Verfangen von Fäden möglich
 No thread, no danger of suture getting caught
 no rosca, no existe peligro de enredo de las suturas
 aucun vis, les fils de suture ne peuvent plus s'emmêler
 no filettatura, nessun pericolo di impiglio della sutura



B13-131-02

Mini-Thorakotomie-Sperrer mit beweglichen Armen
 Mini thoracotomy retractor with adjustable, jointed arms
 Separador mini de toracotomia con brazos móviles
 Écarteur mini-thoracotomie à bras mobiles
 Divaricatore mini per toracotomia con bracci mobili

St	für Erwachsene for adults para adultos pour adultes per adulti			
	a x b	c	d	
	B13-131-02	40 x 36 mm	100 mm	140 mm
		55 x 36 mm		
bestehend aus consisting of formado por composé de consistente in		2 Paar Valven 2 pairs of blades 2 pares de valvas 2 paires de valves 2 coppie di valve	Rahmen Frame Bastidor Cadre Telaio	
		B13-131-04 B13-131-05	B13-131-03	



1/2

B13-131-04

40 x 36 mm

- ➔ B13-131-00
- ➔ B13-131-01
- ➔ B13-131-02
- ➔ B13-131-03



1/2

B13-131-05

55 x 36 mm

- ➔ B13-131-00
- ➔ B13-131-01
- ➔ B13-131-02
- ➔ B13-131-03

Sternum and Rib Retractors
 Sternum- und Rippensperrer
 Separadores esternales y costales
 Écarteurs à sternum et des côtes
 Divaricatori per sterno e costali



13

abnehmbarer Griff für ein freies OP-Feld

detachable handle for unobstructed view
 of the surgical site

mango desmontable para una visión sin obstáculos
 del campo operatorio

poignée amovible pour un champ
 opératoire libre

impugnatura smontabile per una visione
 senza ostruzioni del campo operatorio

kein Verfangen von Fäden möglich durch versenktes Gewinde
 für Querstange (C13-132-06)

no danger of suture getting caught, thanks to recessed threads
 for cross-bar (C13-132-06)

no existe peligro de enredo de las suturas gracias a la rosca sumergida
 para varilla transversal (C13-132-06)

les fils de suture ne peuvent plus s'emmêler grâce aux vis encastrées
 pour barre transversale (C13-132-06)

nessun pericolo di impiglio della sutura grazie a filettatura incassata
 per barra trasversale (C13-132-06)

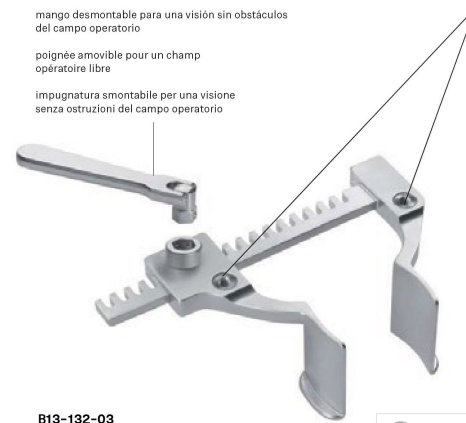

B13-132-03

B13-132-05

Mini-Thorakotomie-Sperrer
 Mini thoracotomy retractor
 Separador mini de toracotomia
 Écarteur mini-thoracotomie
 Divaricatore mini per toracotomia

St	a x b	c	d	
	B13-132-03	45 x 36 mm	76 mm	85 mm
	B13-132-04	60 x 36 mm	76 mm	85 mm
	B13-132-05	80 x 36 mm	76 mm	85 mm

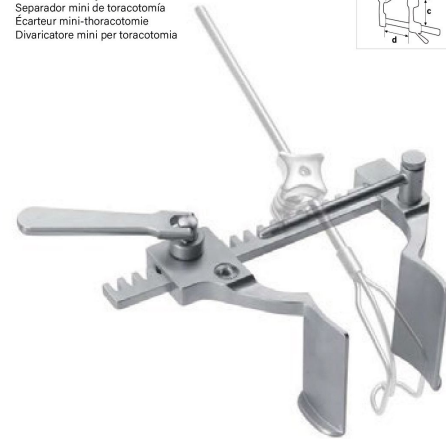

B13-132-00

B13-132-02

Mini-Thorakotomie-Sperrer mit abnehmbarer Querstange
 Mini thoracotomy retractor with detachable cross-bar
 Separador mini de toracotomia con varilla transversal desmontable
 Écarteur mini-thoracotomie avec barre transversale amovible
 Mini-divaricatore per toracotomia con barra trasversale asportabile

St	a x b	c	d	
	B13-132-00	45 x 36 mm	76 mm	85 mm
	B13-132-01	60 x 36 mm	76 mm	85 mm
	B13-132-02	80 x 36 mm	76 mm	85 mm



Sternum and Rib Retractors
 Sternum- und Rippensperrer
 Separadores esternales y costales
 Écarteurs à sternum et des côtes
 Divaricatori per sterno e costali



13

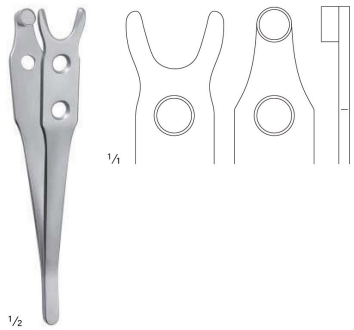

B13-133-99
 Pinzette zum Austauschen von Valven
 Forceps for blade replacement
 Pinza para cambiar las valvas
 Pince pour remplacer les valves
 Pinza per la sostituzione delle valve

- ➔ B13-131-00
- B13-131-01
- B13-131-02
- B13-131-03



B13-132-06
 Querstange
 Cross-bar
 Varilla transversal
 Barra trasversale
 Barra trasversale

- ➔ B13-131-00
- B13-131-01
- B13-132-03
- B13-132-04
- B13-132-05
- B13-132-06

Sternum and Rib Retractors
 Sternum- und Rippensperrer
 Separadores esternales y costales
 Écarteurs à sternum et des côtes
 Divaricatori per sterno e costali



13



B13-134-02
 Fixierelement
 Fixation element
 Elemento de fijación
 Élément de fixation
 Elemento di fissaggio

- ➔ B13-131-00
- B13-131-01
- B13-132-03
- B13-132-04
- B13-132-05
- B13-132-06



B13-134-05
 Haken, biegsam
 Retractor, malleable
 Retractor, maleable
 Rétracteur, flexible
 Retratore, flessibile

- ➔ B13-131-00
- B13-131-01
- B13-132-03
- B13-132-04
- B13-132-05
- B13-132-06



Sternum and Rib Retractors
 Sternum- und Rippensperrer
 Separadores esternales y costales
 Écarteurs à sternum et des côtes
 Divaricatori per sterno e costali



13



Cooley
B13-134-01
B13-134-04

Haken
 Retractor
 Retractor
 Rétracteur
 Retrattores

- ➔ B13-131-00
- B13-131-01
- B13-132-00
- B13-132-01
- B13-132-02
- B13-132-03
- B13-132-04
- B13-132-05
- B13-132-06

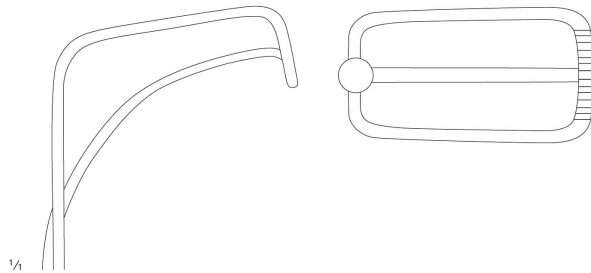

B13-134-01
 35 x 25 mm

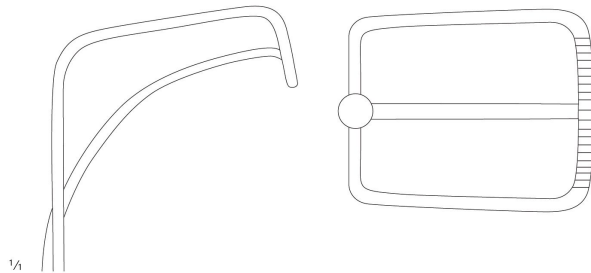

B13-134-03
 40 x 36 mm

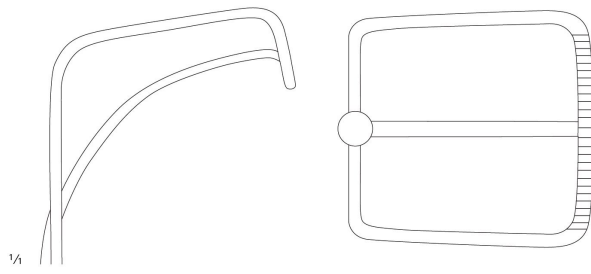

B13-134-04
 50 x 36 mm

Sternum and Rib Retractors
 Sternum- und Rippensperrer
 Separadores esternales y costales
 Écarteurs à sternum et des côtes
 Divaricatori per sterno e costali



13



French IMA
B13-135-00



B13-135-02
 IMA-Valve, french
 IMA blade, french
 Valva IMA, francese
 Valve IMA, française
 Valva IMA, francese
 30 x 100 mm



B13-135-03
 IMA-Valve, french
 IMA blade, french
 Valva IMA, francese
 Valve IMA, française
 Valva IMA, francese
 50 x 22 mm



B13-135-04
 IMA-Valve, french
 IMA blade, french
 Valva IMA, francese
 Valve IMA, française
 Valva IMA, francese
 40 x 22 mm

B13-135-00

St

French-IMA-Konfiguration
 French IMA configuration
 Configuración IMA francesa
 Configuration IMA française
 Configurazione IMA francese

bestehend aus
 consisting of
 formado por
 composé de
 consistente in

3 Valven
 3 blades
 3 valvas
 3 valves
 3 alve

Rahmen
 Frame
 Bastidor
 Cadre
 Telaio

B13-135-02
B13-135-03
B13-135-04

B13-135-01



Sternum Retractors marGate
 Sternumperrerr marGate
 Separadores esternales marGate
 Écarteurs à sternum marGate
 Divaricatori per sterno marGate



13

Exposure, stability and flexibility
 Perfection for valve and bypass surgery



Features marGate

- Ausgezeichnete Exposition des OP-Feldes
- Schneller Valvenwechsel mit nur einem Handgriff
- Kompatibel für Nahthaltereinschübe
- Besonders flaches Design für mehr Übersicht
- Einfaches und schnelles Rastprinzip über das Fixierelement

marGate features

- Outstanding exposure of the surgical field
- Fast valve replacement with just a single movement
- Compatible with suture holding inserts
- Particularly flat design for more overview
- Simple and fast locking via the attachment element

Características marGate

- Excelente exposición del campo quirúrgico
- Cambio rápido de las valvas con una sola maniobra
- Compatible con insertos de sujeción para suturas
- Diseño particularmente plano para mayor
- Enclavamiento sencillo y rápido a través del elemento de fijación

Caractéristiques marGate

- Exposition exceptionnelle du champ opératoire
- Changement rapide de valve avec un geste seulement vista general
- Compatible avec les inserts pour dispositifs de rétention des sutures
- Design particulièrement plat pour davantage de visibilité
- Principe de serrage simple et

Caratteristiche di marGate

- Esposizione straordinaria del campo operatorio
- Rapida sostituzione delle valvole con una sola presa
- Compatibile per inserti di tenuta della sutura rapide sur l'élément de fixation
- Design particolarmente piatto per una maggiore visibilità
- Principio d'arresto semplice e rapido tramite l'elemento di fissaggio

St	B13-136-00		
		a x b	c d
		30 x 100 mm	225 mm 200 mm
	bestehend aus consisting of formato por 1 Paar Valven 1 pairs of blades 1 paires de valves 1 coppie di valve	Rahmen Frame Bastidor Cadre Telaio	
		B13-136-02	B13-136-01

Sternum Retractors marGate
 Sternumperrerr marGate
 Separadores esternales marGate
 Écarteurs à sternum marGate
 Divaricatori per sterno marGate



13



B13-136-01
 Rahmen allein
 Frame only
 Bastidor suelto
 Cadre seul
 Telaio solo



B13-136-02
 30 x 100 mm

B13-136-03
 40 x 100 mm



B13-136-04
 30 x 28 mm

B13-136-05
 40 x 28 mm

➔ B13-136-00
 B13-136-01



Accessories for Sternum Retractors marGate
 Zubehör für Sternumsperrer marGate
 Accesorios para separadores esternales marGate
 Accessoires pour écarteurs à sternum marGate
 Accessori per sterno marGate



13

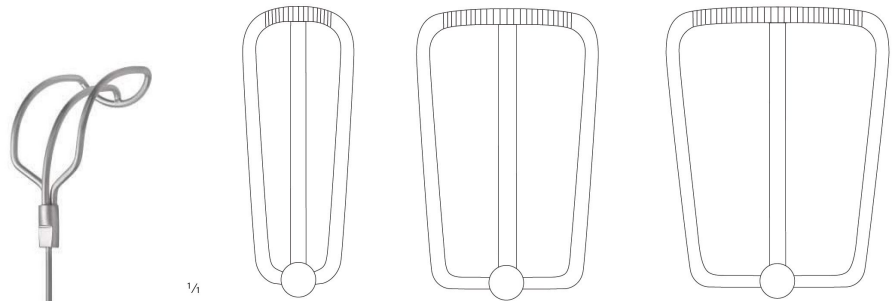

	60 x 20 mm	60 x 35 mm	60 x 45 mm
SR	B13-136-10	B13-136-11	B13-136-12
HR	B13-137-10	B13-137-11	B13-137-12



Cooley
 B13-136-10
 B13-137-12

Atriumhaken, biegsam
 Atrium retractor, malleable
 Retractor auricular, maleable
 Rétracteur atrium, flexible
 Retrattore atrio, flessibile

➔ B13-136-00
 B13-136-01



B13-136-09

Fixierelement
 Fixation element
 Elemento de fijación
 Élément de fixation
 Elemento di fissaggio

➔ B13-136-00
 B13-136-01

29



Accessories for Sternum Retractors marGate
 Zubehör für Sternumsperrer marGate
 Accesorios para separadores esternales marGate
 Accessoires pour écarteurs à sternum marGate
 Accessori per sterno marGate



13

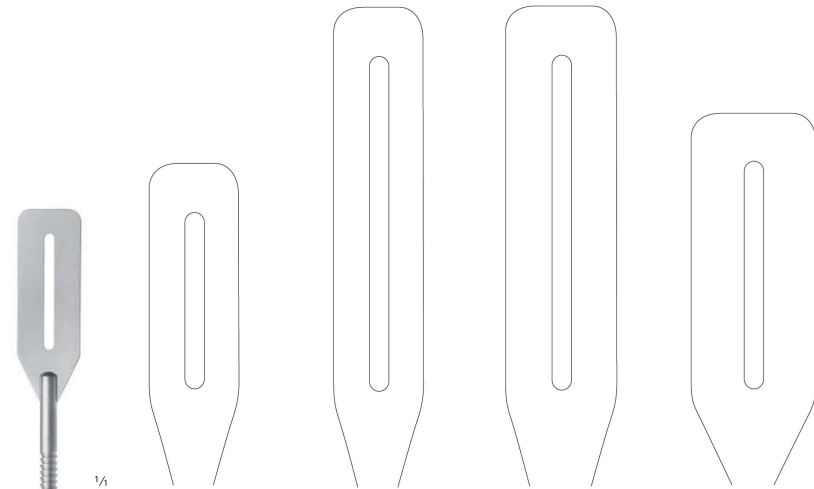

	18 x 65 mm	18 x 95 mm	22 x 95 mm	25 x 75 mm
SR	B13-136-20	B13-136-21	B13-136-22	B13-136-23
HR	B13-137-20	B13-137-21	B13-137-22	B13-137-23



B13-136-20
 B13-137-23

Klappenhaken, biegsam
 Valve retractor, malleable
 Retractor valvular, maleable
 Rétracteur valves, flexible
 Retrattore valvoia, flessibile

➔ B13-136-00
 B13-136-01



30



Rib Contractors
 Rippenkontraktoren
 Aproximadores para costillas
 Rapprocheurs des côtes
 Approssimatori costali



13



Valven drehbar
 Valves rotatable
 Valvas giratorio
 Valves rotatif
 Valve girevole

1/2

Sellers
B13-138-20
 20 cm / 7 7/8"
 bewegliche Valven
 adjustable blades
 valvas móviles
 valves mobiles
 valve mobili



1/2

Bailey-Baby
B13-139-15
 15,5 cm / 6 1/8"



1/2

Bailey
B13-140-20
 20 cm / 7 7/8"
 kurze Klauen
 short claws
 garras cortas
 bras courts
 pinze corte



1/2

Bailey-Gibbon
B13-141-20
 20 cm / 7 7/8"
 lange Klauen
 long claws
 garras largas
 bras longs
 pinze lunghe

Wound Spreaders, self-retaining
 Wundspreizer
 Retractores autoestáticos
 Écarteurs autostatiques
 Retrattori autostatici



13

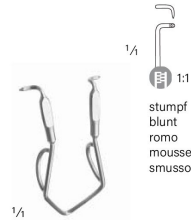

1/4
 1:1
 stumpf
 blunt
 romo
 mousse
 smusso

B13-142-02
 2,5 cm / 1"
 Koronarfatetspreizer
 Epicardial spring retractor
 Retractor de grasa para cirugía coronaria
 Écarteur pour graisse
 Retrattore di grasso per chirurgia coronarica

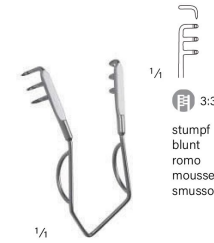

1/4
 3:3
 stumpf
 blunt
 romo
 mousse
 smusso

B13-142-03
 3,5 cm / 1 3/8"
 Koronarfatetspreizer
 Epicardial spring retractor
 Retractor de grasa para cirugía coronaria
 Écarteur pour graisse
 Retrattore di grasso per chirurgia coronarica



1/4
 3:3
 stumpf
 blunt
 romo
 mousse
 smusso

B13-142-04
 4 cm / 1 5/8"
 Koronarfatetspreizer
 Epicardial spring retractor
 Retractor de grasa para cirugía coronaria
 Écarteur pour graisse
 Retrattore di grasso per chirurgia coronarica

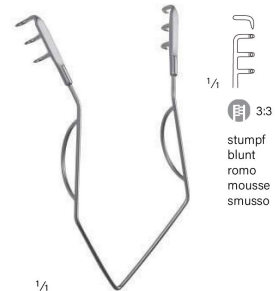

1/4
 3:3
 stumpf
 blunt
 romo
 mousse
 smusso

B13-142-05
 5,5 cm / 2 1/8"
 Koronarfatetspreizer
 Epicardial spring retractor
 Retractor de grasa para cirugía coronaria
 Écarteur pour graisse
 Retrattore di grasso per chirurgia coronarica



Lung Spatulas

Lungenspatel
Espátulas pulmonares
Spatules pulmonaires
Spatole per pulmone



13



13



40 mm
B13-143-29
29,5 cm / 11 5/8"
Arbeitsteil schmal
Working part, narrow
Elemento de trabajo, estrecha
Élément de travail, étroit
Elemento di lavoro, stretto

53 mm
B13-143-33
33 cm / 13"
Arbeitsteil breit
Working part, wide
Elemento de trabajo, ancha
Élément de travail, large
Elemento di lavoro, largo

Allison
B13-143-29
B13-143-33



B13-144-29
29,5 cm / 11 5/8"

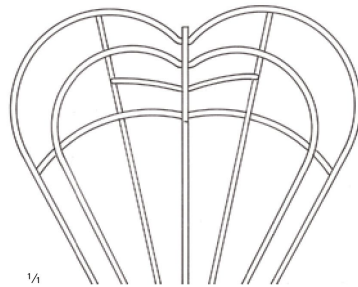

1/4

Bronchus Clamps

Bronchusklemmen
Pinzas bronquiales
Pince-clamps à bronches
Pinze per bronchi



13



Price-Thomas
B13-145-22
22 cm / 8 5/8"



Price-Thomas
B13-146-22
B13-147-22
22 cm / 8 5/8"

Fig. 1

B13-146-22

Fig. 2

B13-147-22



Bronchus Clamps
 Bronchusklemmen
 Pinzas bronquiales
 Pinces-clamps à bronches
 Pinze per bronchi



13



1/2

Semb
 B13-148-25
 B13-148-24



1/4

B13-148-25
 25 cm / 9 7/8"



1/4

B13-148-24
 24,5 cm / 9 5/8"

Shunt Bulldog Clamps
 Shunt-Bulldogklemmen
 Pinzas Bulldog para shunt
 Pinces Bulldog pour carotide
 Pinze Bulldog per shunt



13

Ti



Ø 10 Fr.	B13-149-10	B13-149-25	B13-149-45	B13-149-60
10°	25°	45°	60°	
7,5 cm / 3"	7,5 cm / 3"	7 cm / 2 3/4"	6,5 cm / 2 1/2"	



Ø 12 Fr.	B13-150-10	B13-150-25	B13-150-45	B13-150-60
10°	25°	45°	60°	
7,5 cm / 3"	7,5 cm / 3"	7 cm / 2 3/4"	6,5 cm / 2 1/2"	



1/2

B13-149-10
B13-151-60

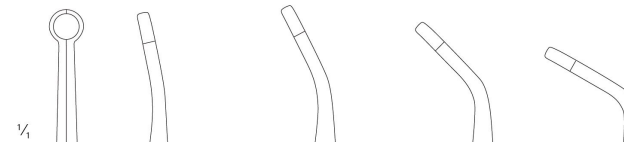

Ø 14 Fr.	B13-151-10	B13-151-25	B13-151-45	B13-151-60
10°	25°	45°	60°	
7,5 cm / 3"	7,5 cm / 3"	7 cm / 2 3/4"	6,5 cm / 2 1/2"	



Lung Grasping Forceps
 Lungenfasszangen
 Pinzas para coger el pulmón
 Pince-clamps à poumons
 Pinze per afferrare polmone



13

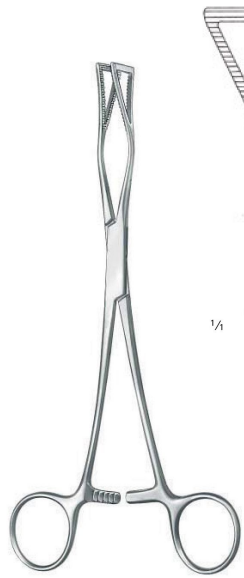

Lovelace
B13-152-20
 20,5 cm / 8 1/8"

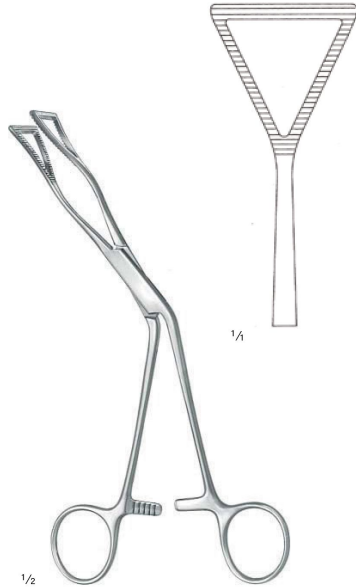

Lovelace
B13-153-19
 19 cm / 7 5/8"

Bulldog Clamps
 Bulldogklemmen
 Clamps Bulldog
 Clamps Bulldog
 Pinze Bulldog



13

Atrauma



1/2

De Bakley
B13-154-08
B13-154-12

St



1/2

De Bakley
B13-155-08
B13-155-13

Ti



1/2

De Bakley
B13-156-08
B13-156-11

St



1/2

De Bakley
B13-157-08
B13-157-11

Ti



1/4

St	B13-154-08	B13-154-09	B13-154-10	B13-154-12
	8 cm / 3 1/8"	9 cm / 3 5/8"	10,5 cm / 4 1/8"	12,5 cm / 4 7/8"
	30 mm	40 mm	55 mm	75 mm

Ti	B13-155-08	B13-155-09	B13-155-11	B13-155-13
	8 cm / 3 1/8"	9 cm / 3 5/8"	11 cm / 4 3/8"	13 cm / 5 1/8"
	25 mm	35 mm	55 mm	75 mm

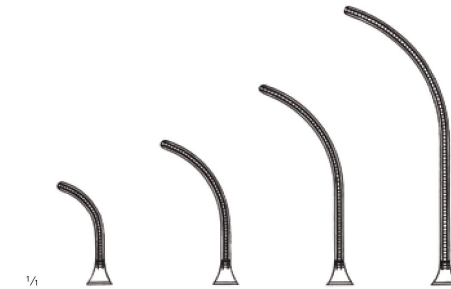

1/4

St	B13-156-08	B13-156-09	B13-156-10	B13-156-11
	8 cm / 3 1/8"	8,5 cm / 3 3/8"	9,5 cm / 3 7/8"	11,5 cm / 4 5/8"
	25 mm	35 mm	50 mm	65 mm

Ti	B13-157-08	B13-157-09	B13-157-10	B13-157-11
	8 cm / 3 1/8"	9 cm / 3 5/8"	10 cm / 3 7/8"	11,5 cm / 4 5/8"
	25 mm	30 mm	45 mm	60 mm



Atrauma 



De Bakey-Satinsky
B13-158-07
 7 cm / 2 3/8"
 27 mm

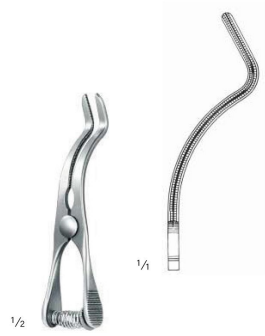

De Bakey-Satinsky
B13-159-09
 9 cm / 3 1/2"
 51 mm



De Bakey-Satinsky
B13-160-10
 10 cm / 3 7/8"
 60 mm



Glover
B13-161-06
 6,5 cm / 2 1/2"
 16 mm



Santulli
B13-162-07
 7 cm / 2 3/4"
 26 mm

Atrauma 



Gregory, soft
B13-163-09
B13-163-11
 Carotis-Bulldogklemme
 Carotid clamp
 Clamp para carotis
 Pince pour carotide
 Pinza carotis



B13-163-09
 9 cm / 3 1/2"
 40 mm



B13-163-11
 11 cm / 4 3/8"
 60 mm



Gregory
B13-164-11
B13-165-11
 Carotis-Bulldogklemme
 Carotid clamp
 Clamp para carotis
 Pince pour carotide
 Pinza carotis



B13-164-11
 11 cm / 4 3/8"
 60 mm



B13-165-11
 11 cm / 4 3/8"
 60 mm



Aortic Clamps
 Aortaklemmen
 Pinzas aórticas
 Pincés-clamps pour aorte
 Pinze per aorta



13

Atrauma



1/2

De Bakey-Rankin
 B13-166-11
 B13-167-16
 16 cm / 6 3/8"

1/4

B13-166-16



B13-167-16



1/2

De Bakey-Mosquito
 B13-168-15
 B13-169-15
 15 cm / 5 7/8"

1/4

B13-168-15



B13-169-15

Aortic Clamps
 Aortaklemmen
 Pinzas aórticas
 Pincés-clamps pour aorte
 Pinze per aorta



13

Atrauma



1/2

Ochsner
 B13-170-22
 22 cm / 8 5/8"

1/4

B



1/2

Diétrich
 B13-171-21
 21 cm / 8 1/4"

1/4



Multi purpose Vascular Clamps
 Mehrzweck-Gefäßklammern
 Pinzas vasculares de usos múltiples
 Pinces vasculaires universelles
 Pinze vascolari universali



13

Atrauma

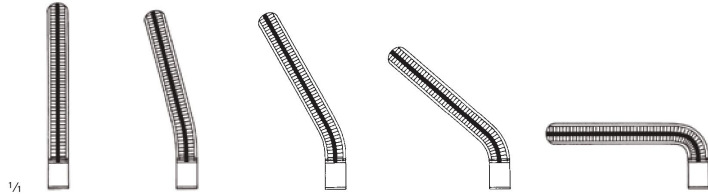

1/4

B13-172-00 16 cm / 6 2/8"	B13-172-15 15,5 cm / 6 1/8"	B13-172-30 15,5 cm / 6 1/8"	B13-172-45 15 cm / 5 7/8"	B13-172-90 13,5 cm / 5 3/8"
-------------------------------------	---------------------------------------	---------------------------------------	-------------------------------------	---------------------------------------



1/4

B13-173-00 17 cm / 6 5/8"	B13-173-15 16,5 cm / 6 5/8"	B13-173-30 16 cm / 6 2/8"	B13-173-45 16 cm / 6 2/8"	B13-173-90 14 cm / 5 5/8"
-------------------------------------	---------------------------------------	-------------------------------------	-------------------------------------	-------------------------------------



1/2

Dardik
B13-172-00
B13-173-90

Peripheral Vascular Clamps
 Peripheral-Gefäßklammern
 Pinzas para vasos periféricos
 Pinces-clamps vasculaires périphériques
 Pinze vascolari periferali



13

Atrauma



1/2

Dale
B13-174-18
 18 cm / 7 1/8"



1/2

Dale
B13-175-17
B13-175-19

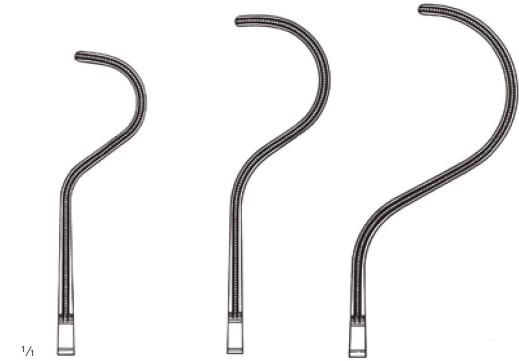

1/4

B13-175-17 17,5 cm / 6 7/8"	B13-175-18 18 cm / 7 1/8"	B13-175-19 18,5 cm / 7 3/8"
---------------------------------------	-------------------------------------	---------------------------------------



Profunda Clamps
 Profundklemmen
 Pinzas para la profunda
 Pinces fémorale
 Pinze profunda



13

Atrauma



1/2

Gregory
 B13-176-14
 B13-176-18



1/4

B13-176-14
 13,5 cm / 5 3/8"



B13-176-16
 16 cm / 6 3/8"



B13-176-18
 18 cm / 7 1/8"

Carotid Shunt Clamps
 Carotis-Shuntklemmen
 Pinzas para shunt carotido
 Pinces pour carotide
 Pinze carotis



13



1/2

Javid
 B13-177-17
 17,5 cm / 6 7/8"



1/2

Javid
 B13-178-18
 18,5 cm / 7 3/8"



Peripheral Vascular Clamps
 Peripherel-Gefäßklemmen
 Pinzas para vasos periféricos
 Pinces-clamps vasculaires périphériques
 Pinze vascolari periferali



13

Atrauma

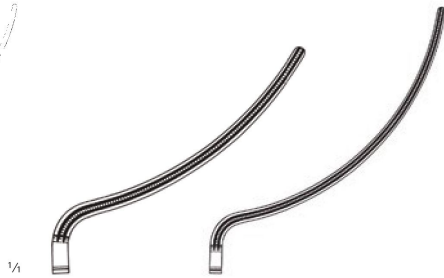

B13-179-16
16 cm / 6 1/4"

B13-179-18
18 cm / 7 1/8"

Martin
B13-179-16
B13-179-18

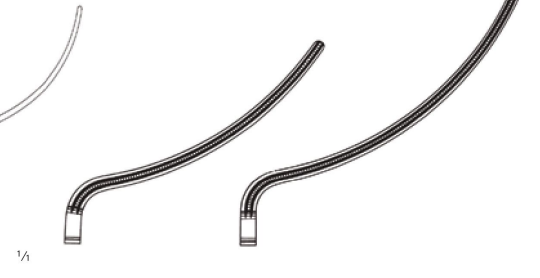

B13-180-17
17 cm / 6 5/8"

B13-180-19
19,5 cm / 7 5/8"

Martin
B13-180-17
B13-180-19

47



Aortic Clamps
 Aortaklemmen
 Pinzas aórticas
 Pinces-clamps pour aorte
 Pinze per aorta



13

Atrauma



Wylie
B13-181-24
 24 cm / 9 1/2"



Wylie
B13-182-27
 27 cm / 10 5/8"



48



Aortic Clamps
 Aortaklemmen
 Pinzas aórticas
 Pincés-clamps pour aorte
 Pinze per aorta



13

Atrauma

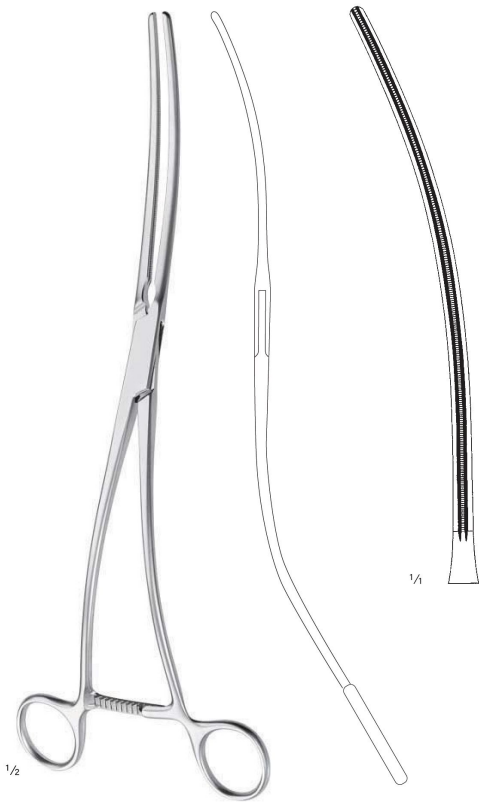

De Bakey
B13-183-30
 30 cm / 11 5/8"



Peripheral Vascular Clamps
 Peripherel-Gefäßklemmen
 Pinzas para vasos periféricos
 Pincés-clamps vasculaires périphériques
 Pinze vascolari periferali



13

Atrauma



Husfeldt
B13-184-16
 16,5 cm / 6 5/8"

Husfeldt
B13-185-18
 18 cm / 7 1/8"

Husfeldt
B13-186-17
 17 cm / 6 5/8"



Vascular Measuring Device, Peripheral Vascular Clamps
 Gefäß-Messzirkel, Peripheräl-Gefäßklemmen
 Compas para medir vasos, Pinzas para vasos periféricos
 Compas pour mesurer la longueur des vaisseaux,
 Pinces-clamps vasculaires périphériques
 Pinza vascolare compasso, Pinze vascolari periferali



13

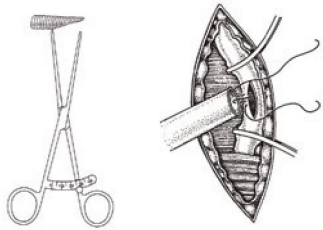

Atrauma

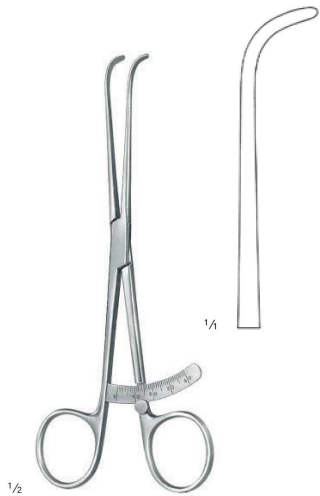

Martin
B13-187-18
 18 cm / 7 1/8"
 Gefäß-Messzirkel
 Vascular Measuring Device
 Compas para medir vasos
 Compas pour mesurer la longueur des vaisseaux
 Pinza vascolare compasso



Henly
B13-188-20
 20 cm / 7 7/8"

51



Catheter Clamps
 Katheterklemmen
 Pinzas para catéteres
 Pinces pour sondes
 Pinze per cateteri



13

Atrauma

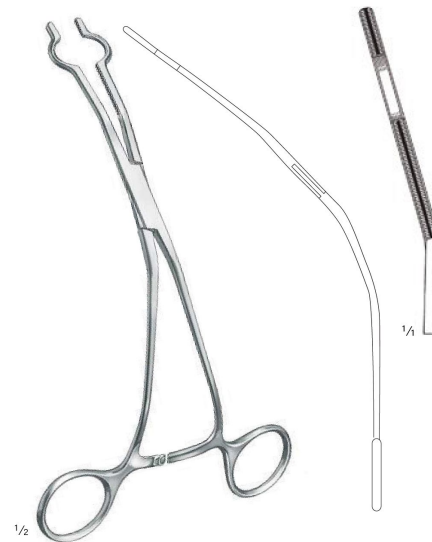

Cooley
B13-189-00
B13-189-07



B13-189-00
 17 cm / 6 5/8"
 20 Charr.



B13-189-01
 17 cm / 6 5/8"
 24 Charr.



B13-189-02
 20 cm / 7 7/8"
 28 Charr.



B13-189-03
 20 cm / 7 7/8"
 30 Charr.



B13-189-04
 20 cm / 7 7/8"
 32 Charr.



B13-189-05
 20 cm / 7 7/8"
 36 Charr.



B13-189-06
 20 cm / 7 7/8"
 38 Charr.



B13-189-07
 20 cm / 7 7/8"
 40 Charr.



52



Abdominal Aortic Clamps
 Abdominale Aortaklemmen
 Pinzas aórticas abdominales
 Pincés-clamps pour aorte abdominaux
 Pinze per aorta addominali



13

Atrauma



B13-190-22
21,5 cm / 8 1/8"

B13-190-25
25 cm / 9 7/8"

B13-190-31
30,5 cm / 12"

Zanger
B13-190-22
B13-190-31

Abdominal Aortic Clamps
 Abdominale Aortaklemmen
 Pinzas aórticas abdominales
 Pincés-clamps pour aorte abdominaux
 Pinze per aorta addominali



13

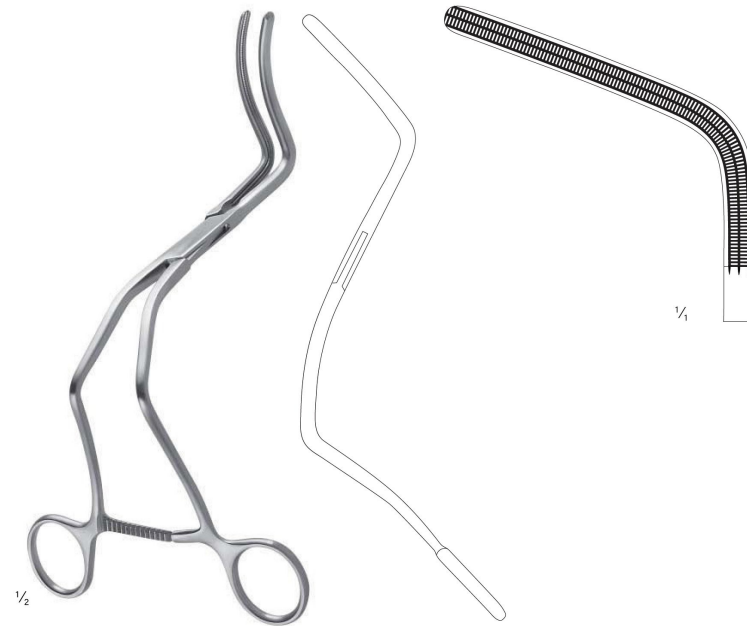

Grant
B13-191-25
 24,5 cm / 9 5/8"



Abdominal Aortic Clamps
 Abdominale Aortaklemmen
 Pinzas aórticas abdominales
 Pincés-clamps pour aorte abdominaux
 Pinze per aorta addominali



13

Atrauma



13

Abdominal Aortic Clamps
 Abdominale Aortaklemmen
 Pinzas aórticas abdominales
 Pincés-clamps pour aorte abdominaux
 Pinze per aorta addominali

Atrauma



Vascular Forceps
Gefäßpinzetten
Pinzas de disección vascular
Pinces à dissection vasculaires
Pinze per dissezione vascolari



13

Atrauma

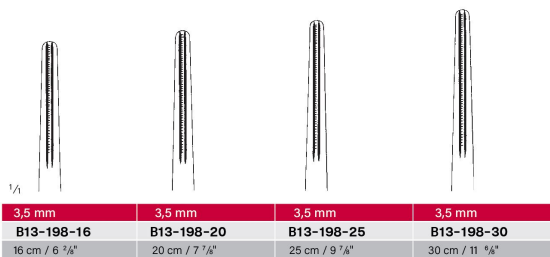
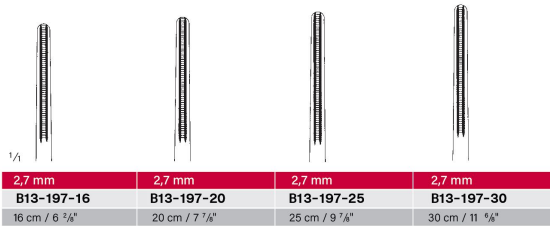
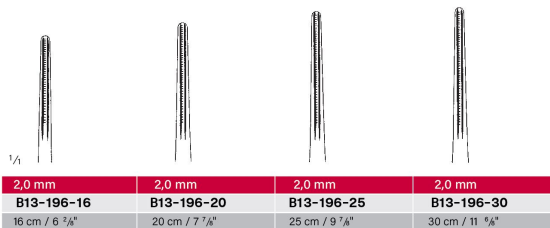
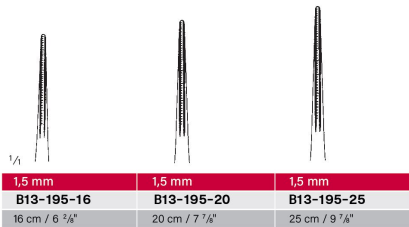

De Bakey
B13-195-19
B13-198-30

57

Vascular Forceps, Bulldog Clamps
Gefäßpinzetten, Bulldogklemmen
Pinzas de disección vascular, Clamps Bulldog
Pinces à dissection vasculaires, Clamps Bulldog
Pinze per dissezione vascolari, Pinze Bulldog



13

Atrauma



De Bakey
B13-199-16
B13-199-30

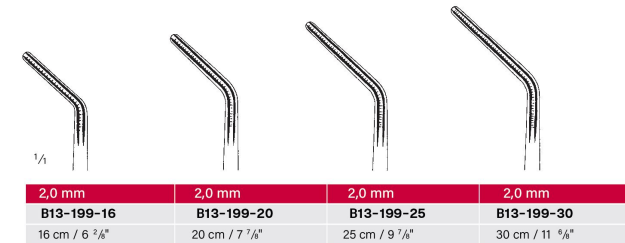

B13-200-01
9,5 cm / 3 3/8"
Gregory-Style
rechts
right
derecho
droit
destra

B13-200-02
9,5 cm / 3 3/8"
Gregory-Style
links
left
izquierdo
gauche
sinistra



58

Bulldog Clamps
Bulldogklemmen
Clamps Bulldog
Clamps Bulldog
Pinze Bulldog



13

Atrauma



1/2

Glover
B13-201-07
B13-201-11



1/4

St	B13-201-07	B13-201-08	B13-201-09	B13-201-11
	7 cm / 2 9/16"	8 cm / 3 1/8"	9,5 cm / 3 9/16"	11 cm / 4 3/8"
	30 mm	40 mm	50 mm	70 mm

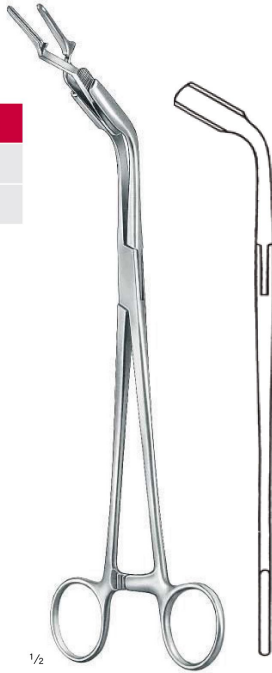

1/2



1/2

Glover
B13-202-06
B13-202-11



1/4

St	B13-202-06	B13-202-07	B13-202-09	B13-202-10
	6,5 cm / 2 9/16"	7,5 cm / 3"	9,0 cm / 3 9/16"	10,5 cm / 4"
	25 mm	35 mm	45 mm	65 mm

B13-203-24
24 cm / 9 9/16"
Anlegezange für Bulldogklemmen
Applying Forceps for Bulldog clamps
Pinza aplicadora para clamps bulldog
Pince pour poser les clamps Bulldog
Pinza per posizionare le pinze Bulldog

59



Coarctation Clamps
Coarctationsklemmen
Pinzas para coarctación
Pinces-clamps pour coarctation
Pinze per coarctazione



13

Atrauma



1/2

Potts
B13-204-21
B13-204-22



1/4

B13-204-21
21 cm / 8 5/16"



B13-204-22
22,5 cm / 8 1/4"



1/2

Potts
B13-205-21
B13-205-22



1/4

B13-205-21
20,5 cm / 8 1/8"



B13-205-22
22 cm / 8 5/8"

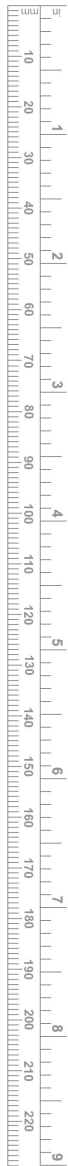

60



Coarctation Clamps
 Coarctationsklemmen
 Pinzas para coarctación
 Pincès-clamps pour coarctation
 Pinze per coarctazione



13

Atrauma



Potts
 B13-206-21
 B13-206-22

B13-206-21
 20,5 cm / 8"

B13-206-22
 22 cm / 8 5/8"

Anastomosis Clamps, Ligature Forceps
 Anastomosenklemmen, Ligaturklemmen
 Pinzas para anastomosis, Pinzas para ligaduras
 Pincès-clamps à anastomose, Pincès à ligatures
 Pinze per anastomosi, Pinze per legature



13

Atrauma



Potts
 B13-207-21
 B13-207-22

B13-207-21
 21,5 cm / 8 1/2"

B13-207-22
 22 cm / 8 5/8"

De Bakey
 B13-208-19
 B13-208-24

B13-208-19
 19 cm / 7 1/2"

B13-208-24
 24 cm / 9 1/2"



Peripheral Vascular Clamps
 Peripheral-Gefäßklemmen
 Pinzas para vasos periféricos
 Pincès-clamps vasculaires périphériques
 Pinze vascolari periferali



13

Atrauma



De Bakey
B13-209-16
 16 cm / 6 1/8"

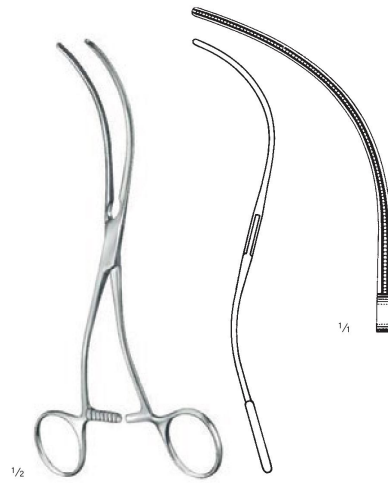

De Bakey
B13-210-19
 19 cm / 7 1/8"



De Bakey
B13-211-20
 20 cm / 7 7/8"

Peripheral Vascular Clamps
 Peripheral-Gefäßklemmen
 Pinzas para vasos periféricos
 Pincès-clamps vasculaires périphériques
 Pinze vascolari periferali



13

Atrauma



Leland-Jones
B13-212-18
B13-212-20

B13-212-18
 18 cm / 7 1/8"

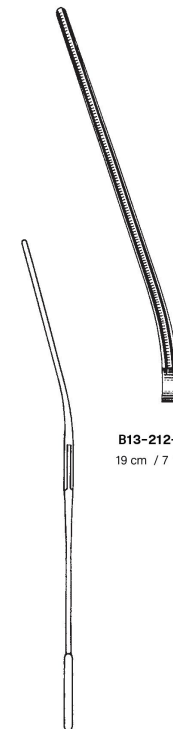

B13-212-19
 19 cm / 7 4/8"

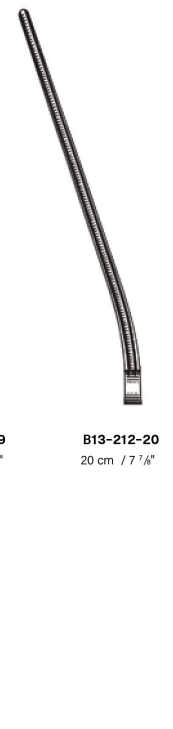

B13-212-20
 20 cm / 7 7/8"



Multi purpose Vascular Clamps
 Mehrzweck-Gefäßklemmen
 Pinzas vasculares de usos múltiples
 Pinces vasculaires universelles
 Pinze vascolari universali



13

Atrauma



Bainbridge
 B13-213-15
 B13-213-18



B13-213-15
 15 cm / 5 7/8"



B13-213-18
 18,5 cm / 7 3/8"



Bainbridge
 B13-214-15
 B13-214-18



B13-214-15
 15 cm / 5 7/8"



B13-214-18
 18,5 cm / 7 3/8"



De Bakey
 B13-215-20
 20 cm / 7 7/8"



Aortic Clamps
 Aortaklemmen
 Pinzas aórticas
 Pinces-clamps pour aorte
 Pinze per aorta



13

Atrauma

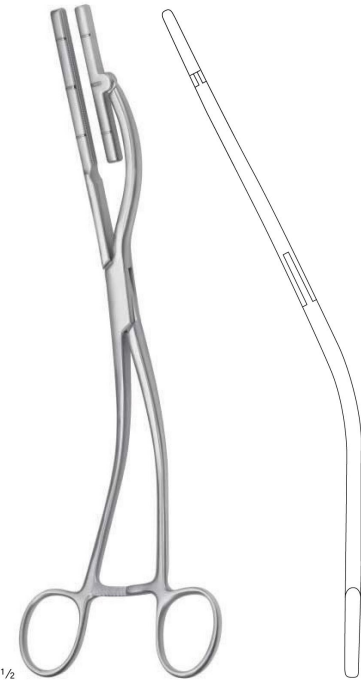

Kowalski
 B13-216-26
 B13-216-28



B13-216-26
 26 cm / 10 2/8"

50 mm



B13-216-27
 27 cm / 10 5/8"

65 mm



B13-216-28
 28 cm / 11"

90 mm



Aortic Aneurysm Clamps
 Aorta-Aneurysmaklemmen
 Pinzas para aneurisma de aórtica
 Pincés-clamps pour anévrisme de l'aorte
 Pinze per aneurisma della aorta



13

Atrauma



De Bakey
 B13-217-26
 B13-217-33

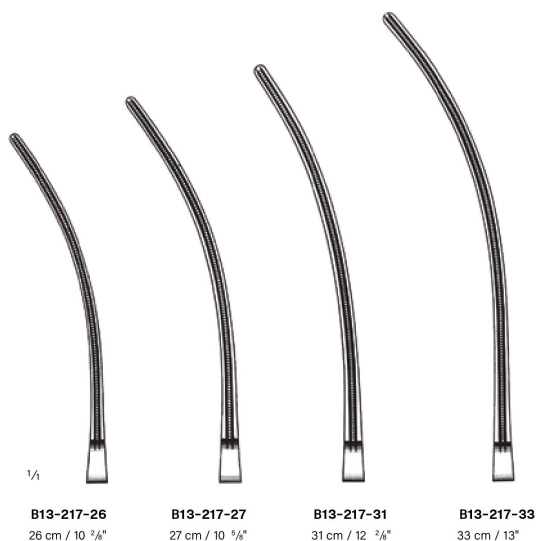

1/4
B13-217-26 26 cm / 10 3/8"
B13-217-27 27 cm / 10 5/8"
B13-217-31 31 cm / 12 3/8"
B13-217-33 33 cm / 13"



Aneurysm Clamps
 Aneurysmaklemmen
 Pinzas para aneurisma
 Pincés-clamps pour anévrisme
 Pinze per aneurisma



13

Atrauma



De Bakey
 B13-218-28
 28 cm / 11"

De Bakey
 B13-219-30
 30 cm / 11 5/8"



Aneurysm Clamps
 Aneurysmaklemmen
 Pinzas para aneurisma
 Pincés-clamps pour anévrisme
 Pinze per aneurisma



13

Atrauma



Cooley
B13-220-25
 25 cm / 9 7/8"

De Bakey
B13-221-27
 27 cm / 10 5/8"

Ligature Forceps, Aortic Clamps
 Ligaturklemmen, Aortaklemmen
 Pinzas para ligaduras, Pinzas aórticas
 Pincés à ligatures, Pincés-clamps pour aorte
 Pinze per legature, Pinze per aorta



13

Atrauma



De Bakey
B13-222-24
 24,5 cm / 9 5/8"

De Bakey
B13-223-24
 24,5 cm / 9 5/8"

De Bakey
B13-224-27
B13-225-27
 27 cm / 10 5/8"

Aortic Clamps
 Aortaklemmen
 Pinzas aórticas
 Pinces-clamps pour aorte
 Pinze per aorta



13

Atrauma



1/4

1/4



1/2

1/2

Weber
 B13-226-24
 24.6cm / 9"

Weber
 B13-227-24
 24 cm / 9 5/8"

71



Aortic Clamps, Anastomosis Clamps, Vena Cava Clamps
 Aorta-, Anastomosen-, Vena-Cava-Klemmen
 Pinzas aórticas, Pinzas para anastomosis, Pinzas para vena cava
 Pinces-clamps pour aorte, Pinces-clamps pour anastomosis,
 Pinzes pour vena cava
 Pinze per aorta, Pinze per anastomosi, Pinze per vena cava



13

Atrauma

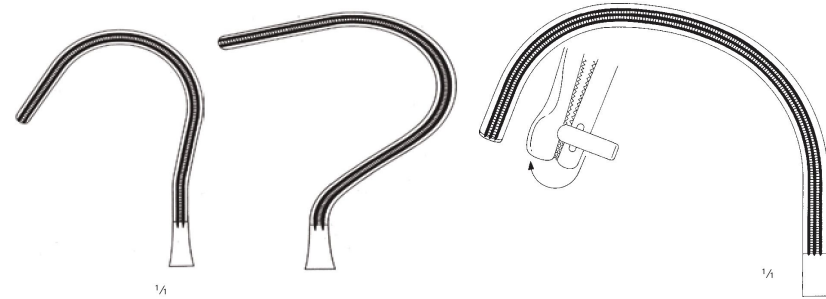

1/4

1/4

1/4

B13-228-22
 22.5 cm / 8 7/8"

B13-228-23
 23 cm / 9"



1/2

1/2

Wylie
 B13-228-22
 B13-228-23



Calne
 B13-229-27
 27 cm / 10 5/8"



72



Liver Forceps
 Leberklemmen
 Pinzas para hígado
 Pinces pour le foie
 Pinze per il fegato



13

Atrauma



Forceps for kidney and pancreas
 Nieren- und Pankreas-Klemmen
 Pinzas para riñón y páncreas
 Pinces pour le rein et pancréas
 Pinze per il rene e pancreas



13

Atrauma

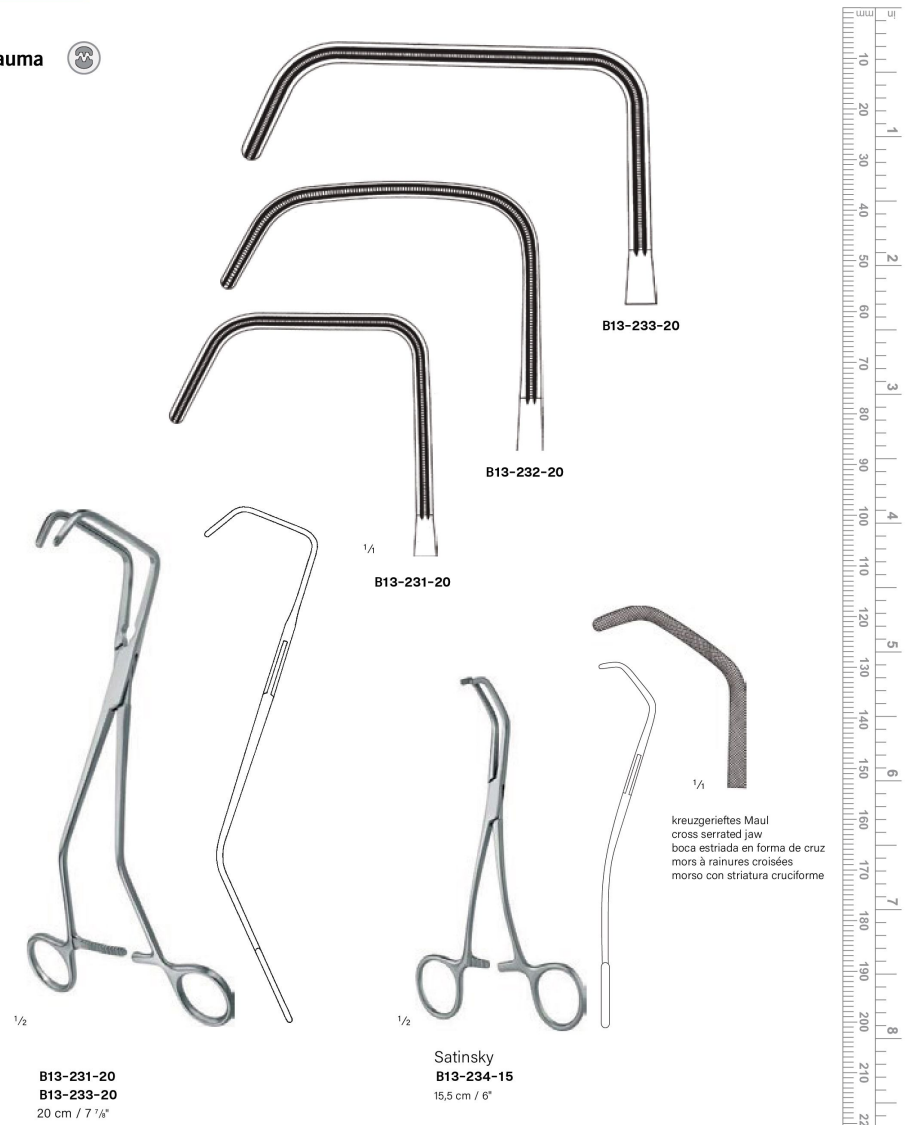

Tangential Occlusion Clamps
 Tangentialklammern
 Pinzas para oclusión tangencial
 Pinces-clamps pour occlusion tangentielle
 Pinze per occlusione tangenziale



13

Atrauma

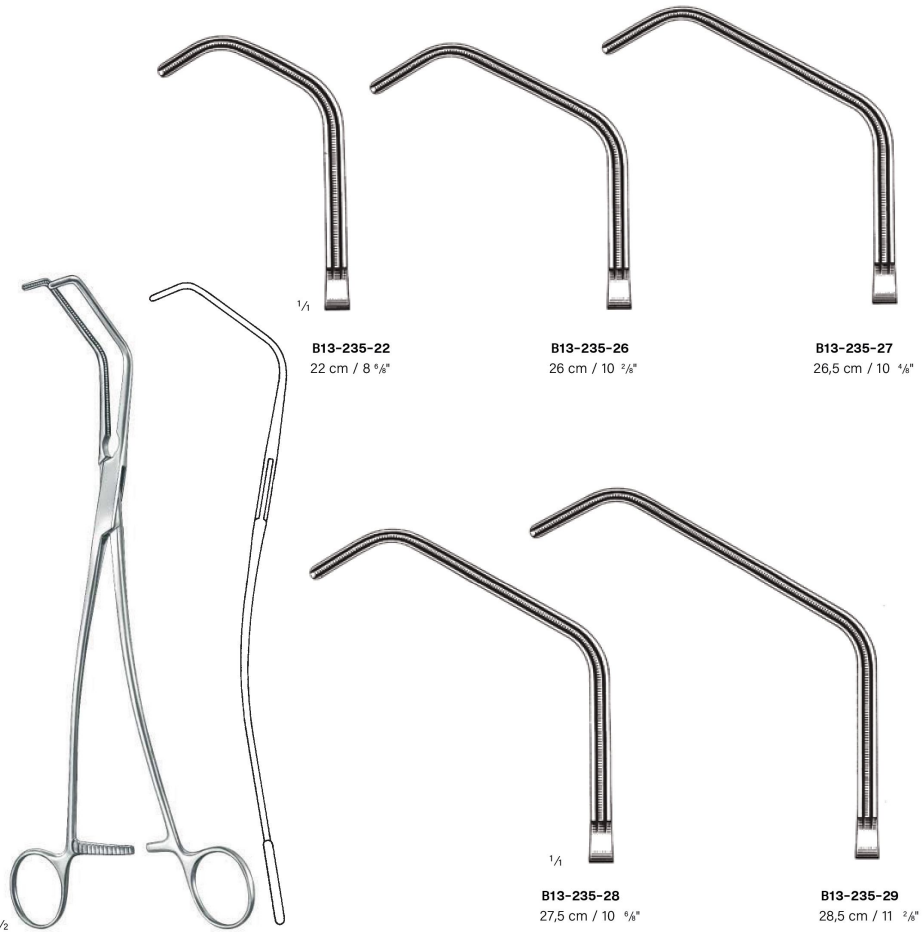

B13-235-22
22 cm / 8 5/8"

B13-235-26
26 cm / 10 1/8"

B13-235-27
26,5 cm / 10 3/8"

B13-235-28
27,5 cm / 10 5/8"

B13-235-29
28,5 cm / 11 1/8"

Satinsky
 B13-235-22
 B13-235-29

Auricle Clamps
 Aurikkelklemmen
 Pinzas para auricula
 Pinces auriculaires
 Pinze ventricolari



13

Atrauma

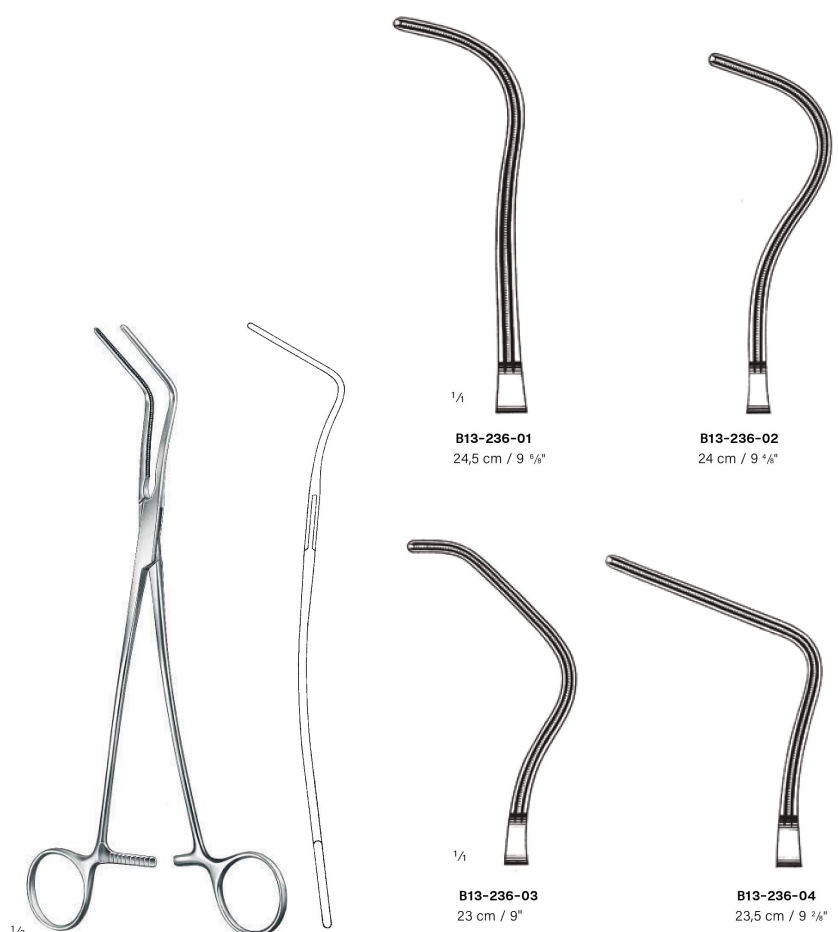

B13-236-01
24,5 cm / 9 5/8"

B13-236-02
24 cm / 9 3/8"

B13-236-03
23 cm / 9"

B13-236-04
23,5 cm / 9 1/8"

Harken
 B13-236-01
 B13-236-04

Bronchusklemmen
Bronchus Clamps
Pinzas bronquiales
Pincas-clamps à bronches
Pinze per bronchi



13

Atrauma



B13-237-23
23 cm / 9"

B13-237-25
25,5 cm / 10"

Lees
B13-238-26
26 cm / 10 1/4"

Lees
B13-237-23
B13-237-25

Anastomosis Clamps
Anastomosenklemmen
Pinzas para anastomosis
Pincas-clamps pour anastomose
Pinze per anastomosi



13

Atrauma



B13-239-18
18 cm / 7 1/8"

B13-239-22
22 cm / 8 5/8"

Glover
B13-239-18
B13-239-22

Aortic Clamps, Anastomosis Clamps
 Aortaklemmen, Anastomosenklemmen
 Pinzas aórticas, Pinzas para anastomosis
 Pinces-clamps pour aorte, Pinces-clamps
 pour anastomose
 Pinze per aorta, Pinze per anastomosi



13

Atrauma



Lambert-Kay
B13-240-22
B13-240-21



B13-240-22
 22,5 cm / 8 5/8"



B13-240-21
 20,5 cm / 8 1/4"



De Bakley
B13-241-16
 16,5 cm / 6 1/2"

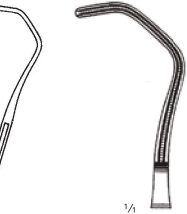

Aortic Clamps
 Aortaklemmen
 Pinzas aórticas
 Pinces-clamps pour aorte
 Pinze per aorta



13

Atrauma



B13-242-18
 18,5 cm / 7 3/8"

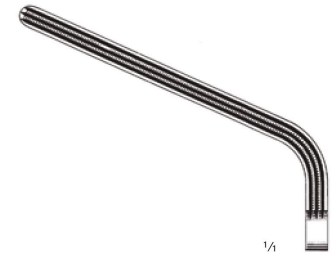

B13-242-20
 20 cm / 8"



B13-242-26
 26 cm / 10 3/8"



Morris-De Bakley
B13-242-18
B13-242-27

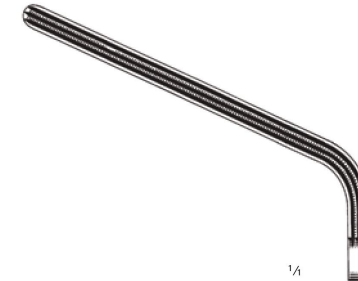

B13-242-27
 27,5 cm / 10 7/8"



Aneurysm Clamps
 Aneurysmaklemmen
 Pinzas para aneurisma
 Pincas-clamps pour anévrisme
 Pinze per aneurisma



13

Atrauma



1/2

De Bakey-Bahnsen
 B13-243-23
 B13-243-26

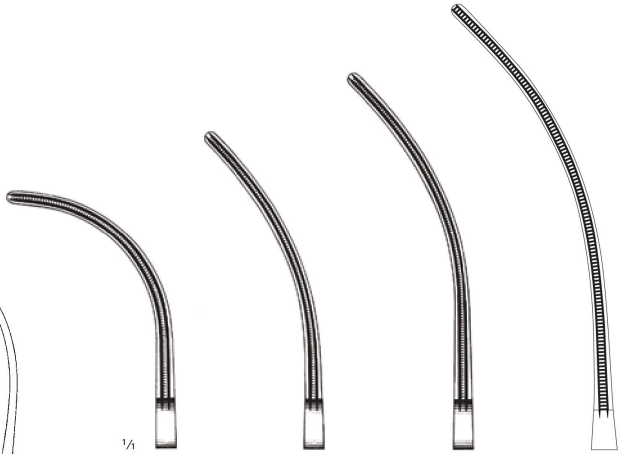

1/4
 B13-243-23
 23,5 cm / 9 3/8"

B13-243-24
 24,5 cm / 9 5/8"

B13-243-25
 25,5 cm / 10"

B13-243-26
 26,5 cm / 10 5/8"

81



Multi purpose Vascular Clamps
 Mehrzweck-Gefäßklemmen
 Pinzas vasculares de usos múltiples
 Pincas vasculaires universelles
 Pinze vascolari universali



13

Atrauma



1/2

Potts
 B13-244-21
 B13-244-31



1/4
 B13-244-21
 21,5 cm / 8 5/8"

B13-244-23
 23,5 cm / 9 3/8"

B13-244-27
 27 cm / 10 5/8"

B13-244-31
 31,5 cm / 12 3/8"



1/2

Potts
 B13-245-21
 B13-245-31



1/4
 B13-245-21
 21 cm / 8 3/8"

B13-245-23
 23 cm / 9"

B13-245-26
 26 cm / 10 3/8"

B13-245-31
 31 cm / 12 3/8"



82



Multi purpose Vascular Clamps
 Mehrzweck-Gefäßklemmen
 Pinzas vasculares de usos múltiples
 Pinces vasculaires universelles
 Pinze vascolari universali



13

Atrauma



B13-246-27
 27,5 cm / 10 9/16"



B13-246-23
 23 cm / 9"



B13-246-20
 20 cm / 7 7/8"



B13-246-19
 19 cm / 7 4/8"



De Bakey
B13-246-19
B13-246-27



Multi purpose Vascular Clamps
 Mehrzweck-Gefäßklemmen
 Pinzas vasculares de usos múltiples
 Pinces vasculaires universelles
 Pinze vascolari universali



13

Atrauma



1/4

B13-247-18
 18 cm / 7 1/8"

B13-247-21
 21 cm / 8 3/8"

B13-247-22
 22 cm / 8 5/8"

B13-247-26
 26 cm / 10 2/8"

B13-247-31
 31,5 cm / 12 3/8"



De Bakey
B13-247-18
B13-247-31



Haemostatic Forceps
 Arterienklemmen
 Pinzas hemostáticas
 Pinces hémostatiques
 Pinze emostatiche



13

Atrauma



De Baquey-Mosquito
 B13-248-12
 B13-249-12
 12,5 cm / 4 7/8"

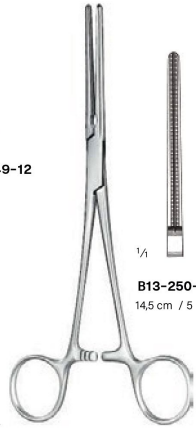

De Baquey-Pean
 B13-250-14
 B13-250-20

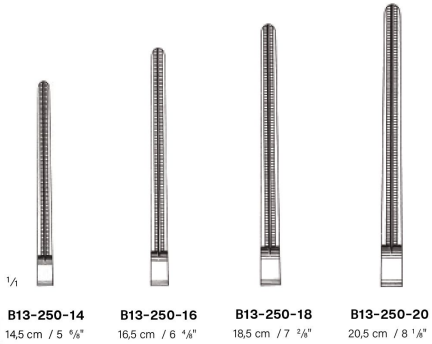

De Baquey-Pean
 B13-251-14
 B13-251-20



Multi purpose Vascular Clamps
 Mehrzweck-Gefäßklemmen
 Pinzas vasculares de usos múltiples
 Pinces vasculaires universelles
 Pinze vascolari universali



13

Atrauma



De Baquey
 B13-252-17
 17,5 cm / 6 7/8"



De Baquey
 B13-253-16
 B13-255-15

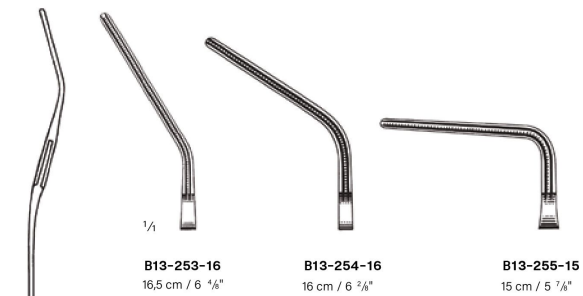

Multi purpose Vascular Clamps
 Mehrzweck-Gefäßklammern
 Pinzas vasculares de usos múltiples
 Pinces vasculaires universelles
 Pinze vascolari universali



13

Atrauma



De Bakey
B13-256-16
 16,5 cm / 6 5/8"



Glover
B13-257-17
 17 cm / 6 3/4"



Glover
B13-258-17
B13-258-26



B13-258-17
 17,5 cm / 6 7/8"



B13-258-21
 21 cm / 8 2/8"



B13-258-26
 26 cm / 10 1/8"

Anastomosis Clamps
 Anastomosenklammern
 Pinzas para anastomosis
 Pinces pour anastomose
 Pinze per anastomosi



13

Atrauma



De Bakey
B13-259-16
B13-260-16
 16,5 cm / 6 5/8"

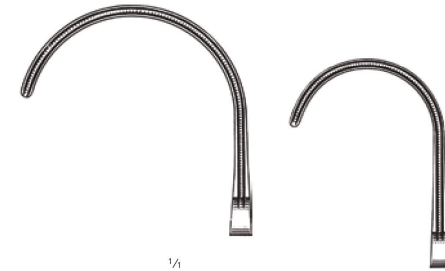

B13-259-16



B13-260-16

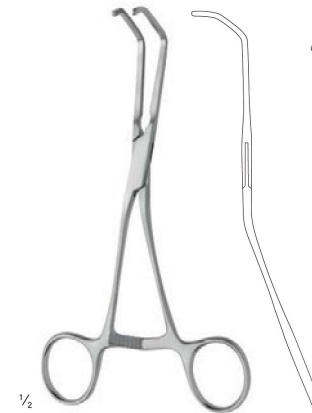

De Bakey-Reynolds
B13-261-16
B13-261-17

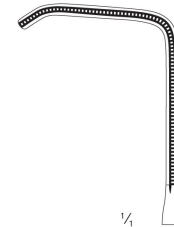

B13-261-16
 16,5 cm / 6 5/8"



B13-261-17
 17,5 cm / 6 7/8"



Anastomosis Clamps
Anastomosenklemmen
Pinzas para anastomosis
Pinces pour anastomose
Pinze per anastomosi



13

Atrauma



Derra
B13-262-16
B13-262-18



Fig. 1
B13-262-16
16,5 cm / 6 5/8"



Fig. 2
B13-262-17
17 cm / 6 3/4"



Fig. 3
B13-262-18
17,5 cm / 6 7/8"



De Bakey-Beck
B13-263-17
B13-263-21



B13-263-17
17 cm / 6 5/8"

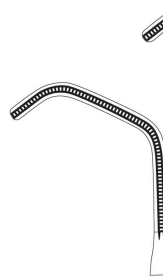

B13-263-19
19 cm / 7 1/2"

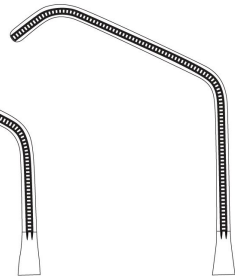

B13-263-21
21 cm / 8 1/4"

Pediatric Vascular Clamps
Kinder-Gefäßklemmen
Pinzas vasculares pediátricas
Pinces vasculaires pédiatriques
Pinze vascolari pediatriche



13

Atrauma



De Bakey
B13-264-10
B13-266-13



B13-264-10
10 cm / 3 7/8"



B13-265-13
13 cm / 5 1/8"



B13-266-13
13 cm / 5 1/8"



De Bakey
B13-267-12
B13-268-12
12,5 cm / 4 7/8"



B13-267-12



B13-268-12



Pediatric Vascular Clamps
 Kinder-Gefäßklemmen
 Pinzas vasculares pediátricas
 Pinces vasculaires pédiatriques
 Pinze vascolari pediatriche



13

Ti



B13-269-01
13 cm / 5 1/8"



B13-269-02
12,5 cm / 4 7/8"



B13-269-03
12 cm / 4 3/8"



1/2

Castañeda
B13-269-01
B13-269-06

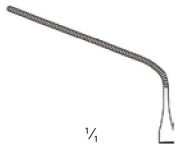

B13-269-04
12 cm / 4 3/8"



B13-269-05
11 cm / 4 3/8"



B13-269-06
12 cm / 4 3/8"

91



Pediatric Vascular Clamps
 Kinder-Gefäßklemmen
 Pinzas vasculares pediátricas
 Pinces vasculaires pédiatriques
 Pinze vascolari pediatriche



13

Ti



B13-270-01



B13-270-02



B13-270-03



1/2

Castañeda
B13-270-01
B13-270-05
 15 cm / 5 7/8"

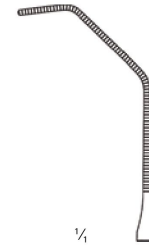

B13-270-04



B13-270-05



92



Pediatric Vascular Clamps
 Kinder-Gefäßklemmen
 Pinzas vasculares pediátricas
 Pinces vasculaires pédiatriques
 Pinze vascolari pediatriche



13

Atrauma



De Bakey baby
 B13-271-01
 B13-271-11

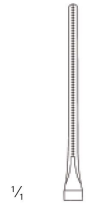

B13-271-01
 13,5 cm / 5 3/8"



B13-271-02
 13,5 cm / 5 3/8"



B13-271-03
 13 cm / 5 1/8"

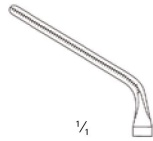

B13-271-04
 12,5 cm / 4 7/8"



B13-271-05
 13,5 cm / 5 3/8"



B13-271-06
 12 cm / 4 3/8"

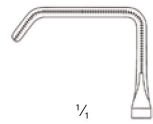

B13-271-07
 12 cm / 4 3/8"



B13-271-08
 12,5 cm / 4 7/8"



B13-271-09
 13 cm / 5 1/8"



B13-271-10
 14 cm / 5 1/2"



B13-271-11
 14 cm / 5 1/2"

Pediatric Vascular Clamps
 Kinder-Gefäßklemmen
 Pinzas vasculares pediátricas
 Pinces vasculaires pédiatriques
 Pinze vascolari pediatriche



13

Atrauma



Cooley
 B13-272-14
 B13-273-14
 14 cm / 5 1/2"



B13-272-14



B13-273-14



Cooley
 B13-274-14
 14 cm / 5 1/2"



1/1



Cooley
 B13-275-13
 13,5 cm / 5 3/8"



1/1



Pediatric Vascular Clamps
 Kinder-Gefäßklemmen
 Pinzas vasculares pediátricas
 Pinces vasculaires pédiatriques
 Pinze vascolari pediatriche



13

Atrauma

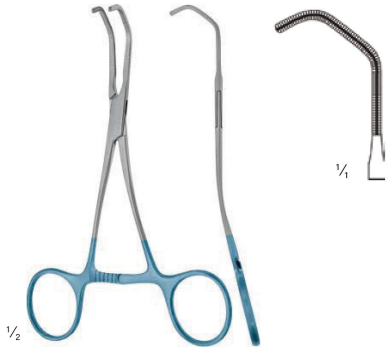

Cooley
 B13-276-13
 13,5 cm / 5 3/8"



Cooley
 B13-277-11
 B13-279-11
 11,5 cm / 4 1/8"

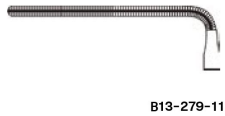
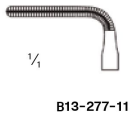

Pediatric Vascular Clamps
 Kinder-Gefäßklemmen
 Pinzas vasculares pediátricas
 Pinces vasculaires pédiatriques
 Pinze vascolari pediatriche



13

Atrauma

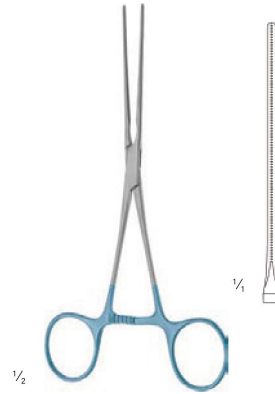

De Bakley baby
 B13-280-16
 16,5 cm / 6 5/8"



De Bakley baby
 B13-281-16
 16 cm / 6 3/8"

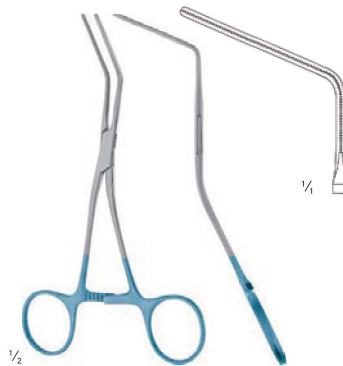

De Bakley baby
 B13-282-15
 15 cm / 5 7/8"



De Bakley baby
 B13-283-15
 B13-284-15
 15 cm / 5 7/8"



Pediatric Vascular Clamps
 Kinder-Gefäßklemmen
 Pinzas vasculares pediátricas
 Pinces vasculaires pédiatriques
 Pinze vascolari pediatriche



13

Atrauma

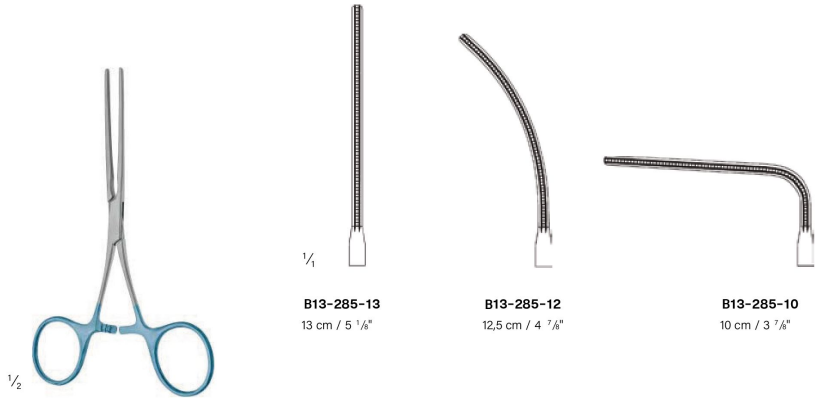

B13-285-13
13 cm / 5 1/8"

B13-285-12
12,5 cm / 4 7/8"

B13-285-10
10 cm / 3 7/8"

De Bakey
B13-285-13
B13-285-10

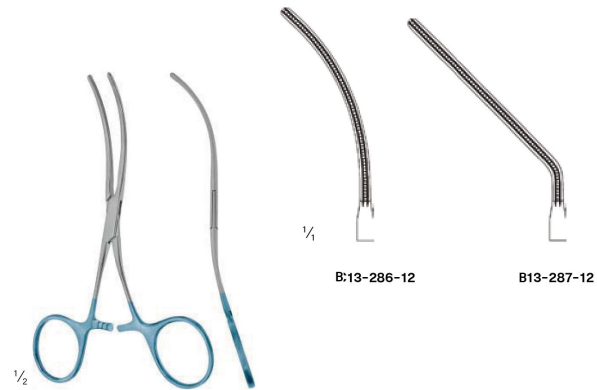

B13-286-12

B13-287-12

De Bakey
B13-286-12
B13-287-12
 12,5 cm / 4 7/8"



Aortic Clamps
 Aortaklemmen
 Pinzas aórticas
 Pinces-clamps pour aorte
 Pinze per aorta



13

Atrauma

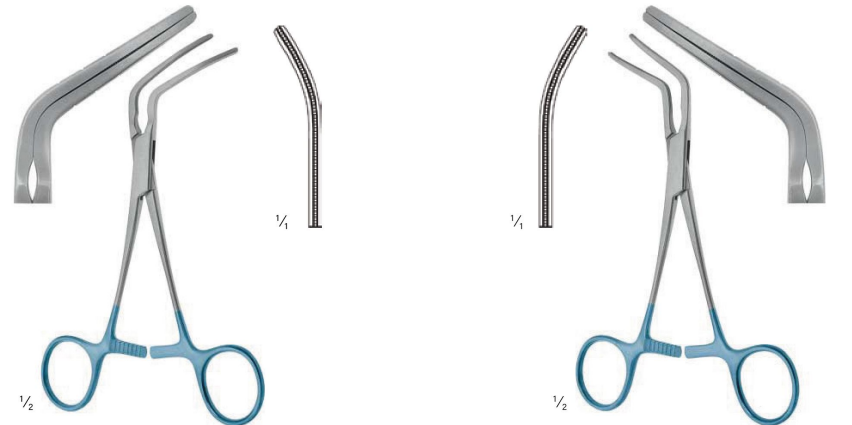

Subramanian
B13-288-15
 15,5 cm / 6 1/8"

Subramanian
B13-289-15
 15,5 cm / 6 1/8"

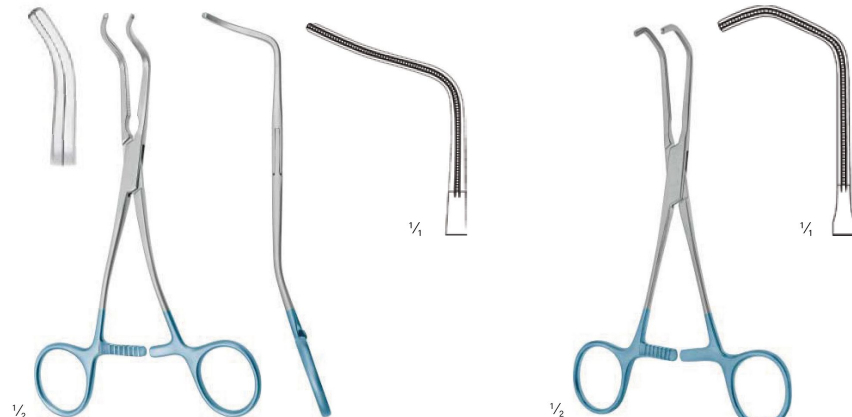

Subramanian
B13-290-16
 16,5 cm / 6 3/8"

De Bakey-Beck
B13-291-16
 16 cm / 6 3/8"



Anastomosis Clamps
 Anastomosenklemmen
 Pinzas para anastomosis
 Pincés-clamps pour anastomose
 Pinze per anastomosi



13

Atrauma

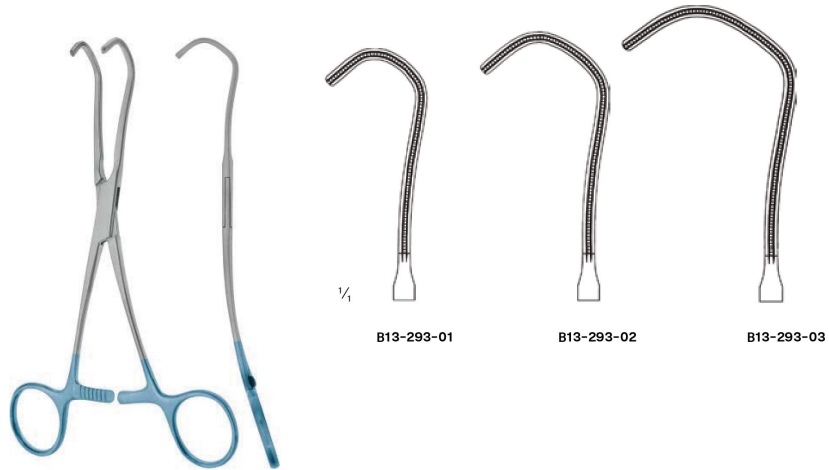

1/2

De Bakey-Derra
 B13-293-01
 B13-293-03
 16,5 cm / 6 1/4"

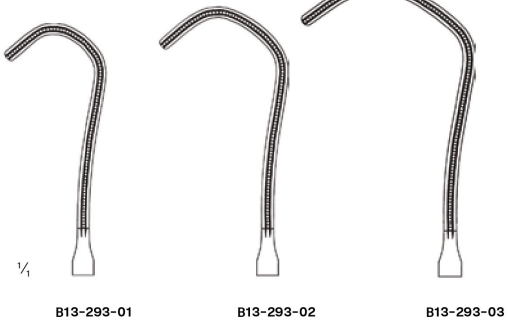

1/4

B13-293-01 B13-293-02 B13-293-03

Tangential Occlusion Clamps
 Tangentialklemmen
 Pinzas para oclusión tangencial
 Pincés-clamps pour occlusion tangentielle
 Pinze per occlusione tangenziale



13

Atrauma

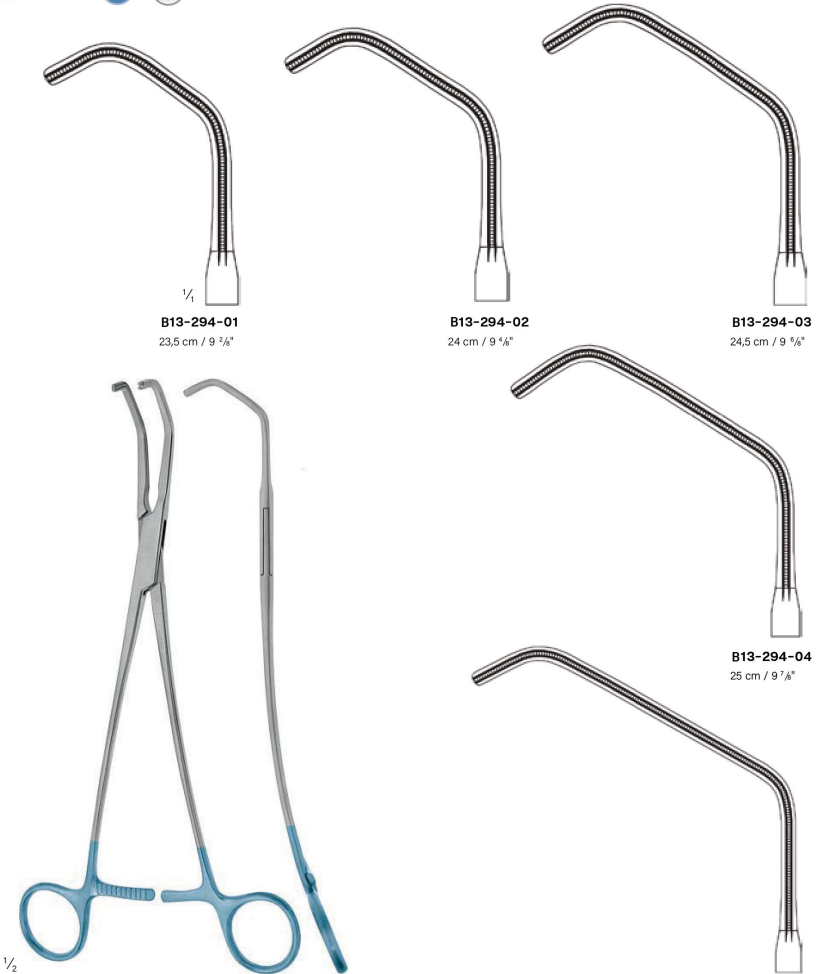

1/2

De Bakey-Satinsky
 B13-294-01
 B13-294-05

1/4
 B13-294-01
 23,5 cm / 9 3/8"

B13-294-02
 24 cm / 9 1/2"

B13-294-03
 24,5 cm / 9 5/8"

B13-294-04
 25 cm / 9 7/8"

B13-294-05
 28,5 cm / 11 1/4"



Anastomosis Clamps
 Anastomosenklemmen
 Pinzas para anastomosis
 Pincés-clamps pour anastomose
 Pinze per anastomosi



13

Atrauma



1/2

1/4

Lambert-Kay
 B13-295-19
 19,5 cm / 7 5/8"

Aortic Clamps
 Aortaklemmen
 Pinzas aórticas
 Pincés-clamps pour aorte
 Pinze per aorta



13

Atrauma



1/2

1/4

B13-296-26
 26 cm / 10 1/8"

B13-296-27
 26,5 cm / 10 5/8"

1/4

B13-296-31
 31 cm / 12 1/4"

B13-296-33
 33 cm / 13"

Vascular Forceps
 Gefäßpinzetten
 Pinzas de disección vascular
 Pinces à dissection vasculaires
 Pinze per dissezione vascolari



13

Atrauma



Cooley
 B13-297-16
 B13-297-20

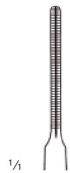

2,0 mm
 B13-297-16
 16 cm / 6 2/8"



2,0 mm
 B13-297-20
 20 cm / 7 7/8"

Pediatric Vascular Clamps
 Kinder-Gefäßklemmen
 Pinzas vasculares pediátricas
 Pinces vasculaires pédiatriques
 Pinze vascolari pediatriche



13

Atrauma



Cooley
 B13-298-01
 B13-298-06



Cooley
 B13-299-14
 14,5 cm / 5 5/8"

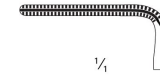

B13-298-01
 11,5 cm / 4 5/8"



B13-298-02
 14,5 cm / 5 5/8"



B13-298-03
 14,5 cm / 5 5/8"



B13-298-04
 14 cm / 5 5/8"



B13-298-05
 14,5 cm / 5 5/8"

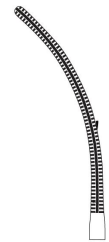

B13-298-06
 12,5 cm / 4 7/8"



Anastomosis Clamps, Multi purpose Vascular Clamps
 Anastomosenklemmen, Mehrzweck-Gefäßklemmen
 Pinzas para anastomosis, Pinzas vasculares de usos múltiples
 Pince-clamps pour anastomose, Pince vasculaires universelles
 Pinze per anastomosi, Pinze vascolari universali



13

Atrauma

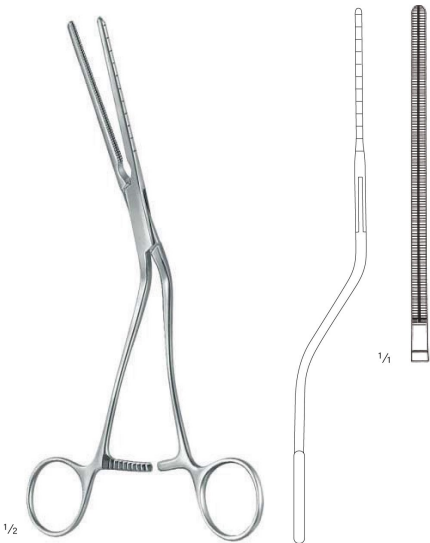

1/2

Cooley
B13-300-22

22 cm / 8 5/8"

Iliacklemme
 Iliac Clamp
 Pinza para iliaca
 Pince-clamps iliaque
 Pinza iliaca



1/2

Cooley
B13-301-17

17 cm / 6 5/8"

Anastomosis Clamps, Multi purpose Vascular Clamps
 Anastomosenklemmen, Mehrzweck-Gefäßklemmen
 Pinzas para anastomosis, Pinzas vasculares de usos múltiples
 Pince-clamps pour anastomose, Pince vasculaires universelles
 Pinze per anastomosi, Pinze vascolari universali



13

Atrauma

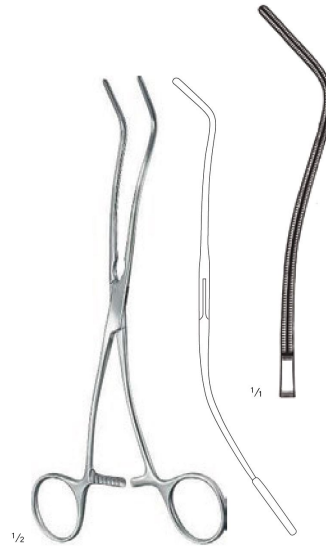

1/2

Cooley
B13-302-20

20 cm / 7 7/8"

Carotisklemme
 Carotid Clamp
 Pinza para carótida
 Pince-clamps pour carotide
 Pinza per carotis



1/2

Cooley-Parry
B13-303-18
B13-303-26

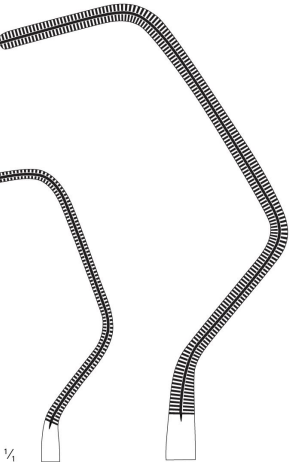

B13-303-18
 18 cm / 7 1/8"

B13-303-26
 26 cm / 10 1/8"



Anastomosis Clamps, Multi purpose Vascular Clamps
 Anastomosenklemmen, Mehrzweck-Gefäßklemmen
 Pinzas para anastomosis, Pinzas vasculares de usos múltiples
 Pincès-clamps pour anastomose, Pincès vasculaires universelles
 Pinze per anastomosi, Pinze vascolari universali



13

Atrauma



1/2
 Cooley
B13-304-17
 17 cm / 6 5/8"



1/2
 Cooley
B13-305-16
 16 cm / 6 1/4"

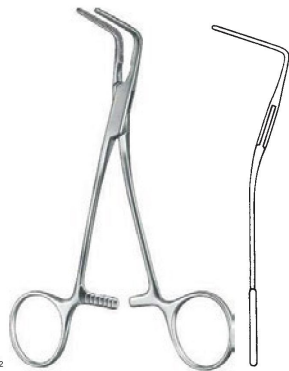

1/2
 Cooley
B13-306-15
B13-306-17



1/4
B13-306-15
 14,5 cm / 5 3/4"



B13-306-16
 16 cm / 6 1/4"



B13-306-17
 16,5 cm / 6 1/2"

Anastomosis Clamps
 Anastomosenklemmen
 Pinzas para anastomosis
 Pincès-clamps pour anastomose
 Pinze per anastomosi



13

Atrauma

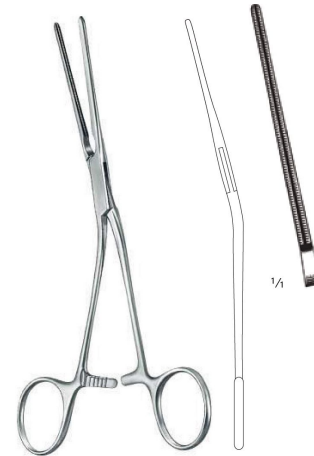

1/2
 Cooley
B13-307-17
 17 cm / 6 5/8"

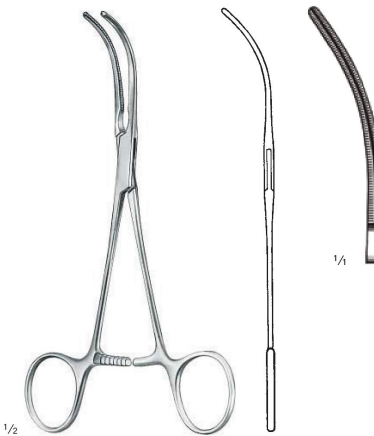

1/2
 Cooley
B13-308-17
 17 cm / 6 5/8"



Anastomosis Clamps
 Anastomosenklemmen
 Pinzas para anastomosis
 Pincés-clamps pour anastomose
 Pinze per anastomosi



13

Atrauma



Cooley
 B13-309-26
 B13-311-28

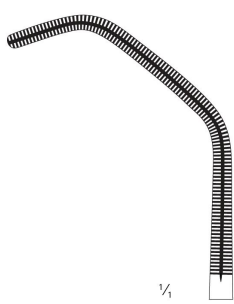

$\frac{1}{4}$
 B13-309-26
 26,5 cm / 10 $\frac{5}{8}$ "

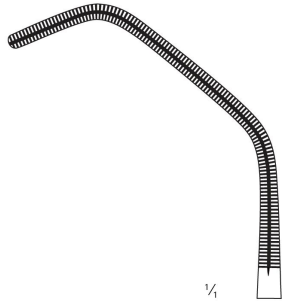

$\frac{1}{4}$
 B13-310-26
 26,5 cm / 10 $\frac{5}{8}$ "

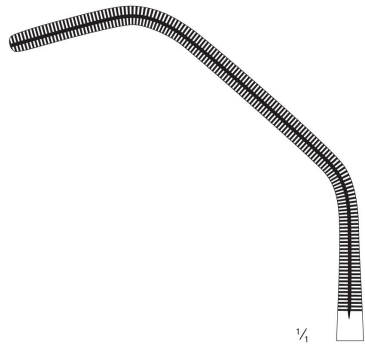

$\frac{1}{4}$
 B13-311-28
 27,5 cm / 10 $\frac{9}{16}$ "

Anastomosis Clamps
 Anastomosenklemmen
 Pinzas para anastomosis
 Pincés-clamps pour anastomose
 Pinze per anastomosi



13

Atrauma

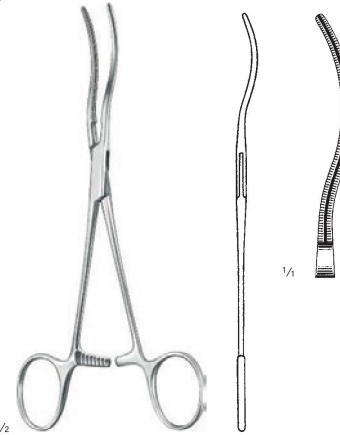

Cooley
 B13-312-17
 17,5 cm / 6 $\frac{7}{16}$ "



Cooley
 B13-313-16
 B13-314-16
 16,5 cm / 6 $\frac{5}{16}$ "



$\frac{1}{4}$
 B13-313-16



B13-314-16



Anastomosis Clamps
 Anastomosenklemmen
 Pinzas para anastomosis
 Pincas-clamps pour anastomose
 Pinze per anastomosi

Atrauma

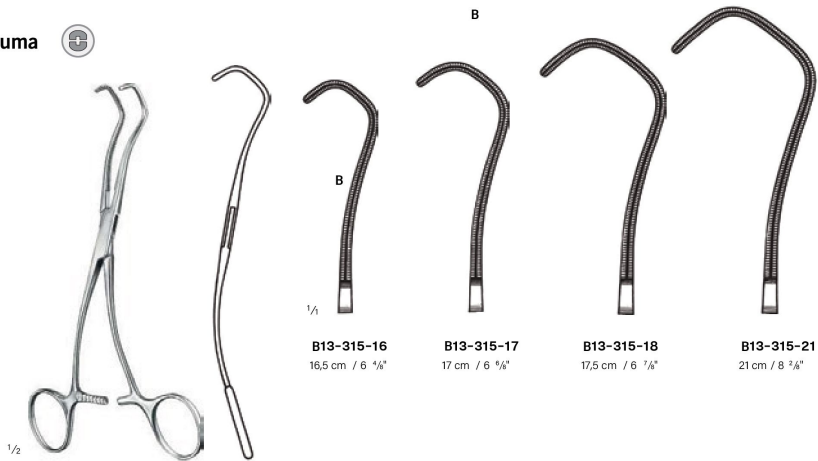

B13-315-16
 16,5 cm / 6 5/8"

B13-315-17
 17 cm / 6 3/4"

B13-315-18
 17,5 cm / 6 7/8"

B13-315-21
 21 cm / 8 3/4"

Cooley-Derra
B13-315-16
B13-315-21



Cooley-Beck
B13-316-17
 17 cm / 6 5/8"



B13-317-23
 23,5 cm / 9 3/8"

B13-317-26
 26,5 cm / 10 3/8"

Allenberg Cobra
B13-317-23
B13-317-26

Aortic Dilators
 Aorta-Dilatatoren
 Dilatadores aórticos
 Dilatateurs pour aorte
 Dilatatori per aorta



Tubbs
B13-318-00

Spreizweite 8 - 42 mm, mit Feststellschraube
 spreading 8 - 42 mm, with fixation screw
 abertura 8 - 42 mm, con tornillo de ajuste
 ouverture 8 - 42 mm, avec vis de fixation
 apertura totale 8 - 42 mm, con vite di fissazione

für Mitralklappen
 for mitral stenosis
 para estenosis mitral
 pour sténoses mitrales
 per stenosi mitrali

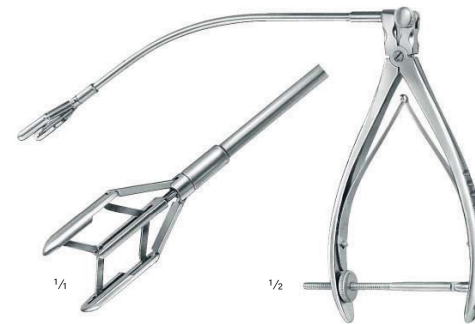

Cooley
B13-319-00

Spreizweite 5 - 20 mm, mit Gewindesperre
 spreading 5 - 20 mm, with thread fixation
 abertura 5 - 20 mm, con fijación de rosca
 ouverture 5 - 20 mm, avec fixation fileté
 apertura totale 5 - 20 mm, con fissazione a filettatura

für Mitralklappen
 for mitral stenosis
 para estenosis mitral
 pour sténoses mitrales
 per stenosi mitrali



Vascular Dilators
 Gefäßdilatoren
 Dilatadores vasculares
 Dilatateurs vasculaires
 Dilatatori vascolari



13



Cooley
 B13-320-05
 B13-327-30

NiTi
 biegsam
 malleable
 maleable
 malléable
 malleabili

	Ø	0.5 mm	1.0 mm	1.5 mm
14 cm / 5 1/8"	St	B13-320-05	B13-320-10	B13-320-15
	Ti	B13-321-05	B13-321-10	B13-321-15
19 cm / 7 1/8"	St	B13-322-05	B13-322-10	B13-322-15
	Ti	B13-323-05	B13-323-10	B13-323-15

	Ø	2.0 mm	2.5 mm	3.0 mm
14 cm / 5 1/8"	St	B13-324-20	B13-324-25	B13-324-30
	Ti	B13-325-20	B13-325-25	B13-325-30
19 cm / 7 1/8"	St	B13-326-20	B13-326-25	B13-326-30
	Ti	B13-327-20	B13-327-25	B13-327-30



13

Vascular Dilators
 Gefäßdilatoren
 Dilatadores vasculares
 Dilatateurs vasculaires
 Dilatatori vascolari



	Ø	0.5 mm	1.0 mm	1.5 mm	2.0 mm
14 cm / 5 1/8"	St	B13-328-05	B13-328-10	B13-328-15	B13-328-20
	Ti	B13-329-05	B13-329-10	B13-329-15	B13-329-20
19 cm / 7 1/8"	St	B13-330-05	B13-330-10	B13-330-15	B13-330-20
	Ti	B13-331-05	B13-331-10	B13-331-15	B13-331-20



DeBaakey
 B13-328-05
 B13-339-90

NiTi
 biegsam
 malleable
 maleable
 malléable
 malleabili

	Ø	2.5 mm	3.0 mm	3.5 mm	4.0 mm
14 cm / 5 1/8"	St	B13-332-25	B13-332-30	B13-332-35	B13-332-40
	Ti	B13-333-25	B13-333-30	B13-333-35	B13-333-40
19 cm / 7 1/8"	St	B13-334-25	B13-334-30	B13-334-35	B13-334-40
	Ti	B13-335-25	B13-335-30	B13-335-35	B13-335-40

	Ø	4.5 mm	5.0 mm	7.0 mm	9.0 mm
14 cm / 5 1/8"	St	B13-336-45	B13-336-50		
	Ti	B13-337-45	B13-337-50		
19 cm / 7 1/8"	St	B13-338-45	B13-338-50	B13-338-70	B13-338-90
	Ti	B13-339-45	B13-339-50	B13-339-70	B13-339-90



Tunneling Set
Tunneller-Set
Juego para tunelar
Jeu pour tunneliser
Set per tunnelare



13



1/4

Martin
B13-340-00

Satz komplett mit 3 Schäften, 2 Griffen und 12 Aufsätzen im Lagerungsbehälter
complete set with 3 shafts, 2 handles and 12 tips in storage case
juego completo con 3 vástagos, 2 mangos y 12 cabezas en caja metálica
jeu complet avec 3 tiges, 2 manches et 12 embouts en boîte métal
Set completo, con 3 gambi, 2 manici con 12 raccordi in contenitore metallico



1/2

B13-340-65

Schraubaufsatz für Venen
Vein Tip
Cabeza para venas
Embouti pour veines
Tata adattatore veni
mit Knopf, Luer-Lock Ansatz
with button, Luer-Lock cone
con botón, cono Luer-Lock
avec bouton, cône Luer-Lock
con bottone, cono Luer-Lock

B13-340-70

Luer-Schraubadapter
Luer Adaptor
Adaptador Luer
Adaptateur Luer
Adattatore Luer
Luer-Lock Ansatz
Luer-Lock cone
cono Luer-Lock
con Luer-Lock

B13-340-99

10 cm / 4"
Schrauben-schlüssel
Wrench
Llave horquilla
Tournevis
Giravite

B13-340-01

12,5 cm / 5"
Universalgriff
Universal Handle
Mango universal
Manche universelle
Manico universale

B13-340-05

24,2 cm
Tunnellerschaft
Tunneling Shaft
Vástago para tunelar
Tige pour tunneliser
Gambo per tunnelare
gebogen
curved
curvo
courbé
curvo

B13-340-06

24,5 cm
Tunnellerschaft
Tunneling Shaft
Vástago para tunelar
Tige pour tunneliser
Gambo per tunnelare
gerade
straight
recto
droite
diritto

B13-340-11

55,5 cm
Tunnellerschaft
Tunneling Shaft
Vástago para tunelar
Tige pour tunneliser
Gambo per tunnelare
gebogen
curved
curvo
courbé
curvo



1/2

B13-340-55

Ø 5 mm
Schraubolive
Screw Olive
Olive
Olive
Olive

B13-340-56

Ø 6 mm
Schraubolive
Screw Olive
Olive
Olive
Olive

B13-340-57

Ø 7 mm
Schraubolive
Screw Olive
Olive
Olive
Olive

B13-340-58

Ø 8 mm
Schraubolive
Screw Olive
Olive
Olive
Olive

B13-340-60

Ø 10 mm
Schraubolive
Screw Olive
Olive
Olive
Olive

B13-340-62

Ø 12 mm
Schraubolive
Screw Olive
Olive
Olive
Olive

B13-341-01

Halteplatte für Aufsätze
Plate for Tips
Soporte para cabezas
Support pour embouts
Supporto per punte

B13-341-55

Metallbehälter
Metal Case
Caja metálica
Boîte métal
Contentore metallico
55 x 11,5 x 3,5 cm

B

115



Fasciotomy Knife, Fasciotomy Spatulas
Fasciotomiemesser, Fasciotomiespatel
Cuchillo para fasciotomia, Espátulas para fasciotomia
Couteau pour fasciotomie, Spatule pour fasciotomie
Bisturi per fasciotomia, Spatole per fasciotomia



13



1/2

Hach
B13-342-30
30 cm / 11 3/8"



1/2

Hach
B13-343-25
B13-34352
30 cm / 11 3/8"



25 mm
B13-343-25

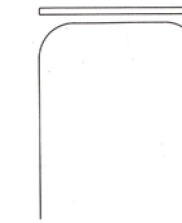

32 mm
B13-343-32

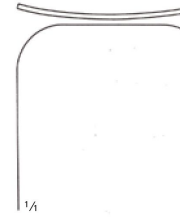

40 mm
B13-343-40

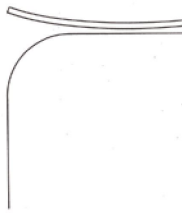

52 mm
B13-343-52



116



Intima Spatulas, Vascular Dissectors

Intimaspädel, Gefäßdissektoren

Espátulas para la íntima, Disecadores vasculares

Spatules pour la tunique interne, Dissecteurs vasculaires

Spatole per íntima, Dissettori vascolari



13

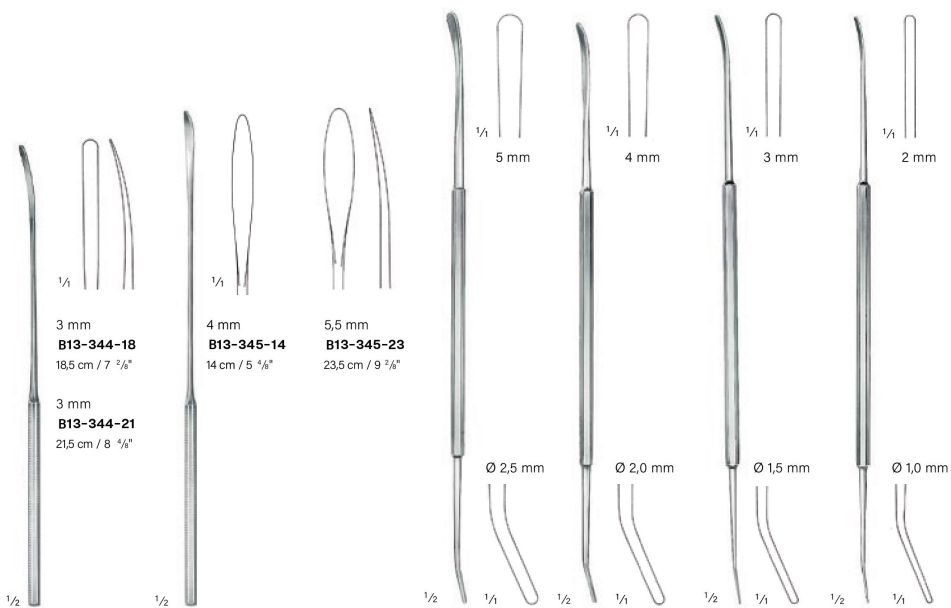

B13-344-18
B13-344-21

B13-345-14
B13-345-23

Fig. 1
Robb
B13-346-01
24 cm / 9 5/8"

Fig. 2
Robb
B13-346-02
24 cm / 9 5/8"

Fig. 3
Robb
B13-346-03
24 cm / 9 5/8"

Fig. 4
Robb
B13-346-04
24 cm / 9 5/8"

Nerve Hooklets, Tourniquets

Nervhäkchen, Fadenfänger, Tourniquets

Ganchitos para nervios, Tourniquetes

Crochets pour les nerfs, Tourniquets

Uncini per nervi, Tornichetti



13

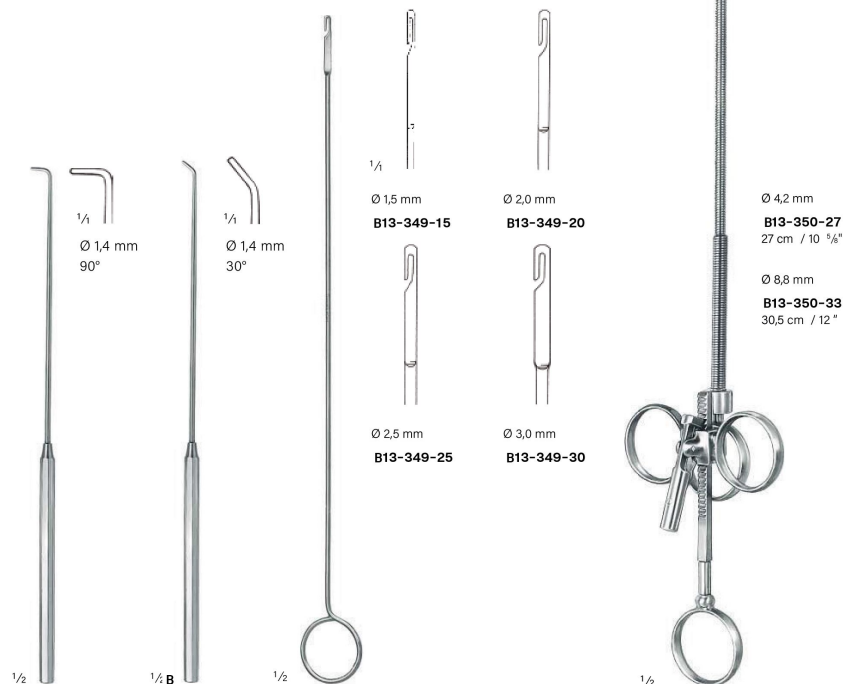

Crile
C13-347-20
20 cm / 7 7/8"

Crile
B13-348-20
20,5 cm / 8 1/8"

B13-349-15
B13-349-30
26 cm / 10 2/8"

Rumel-Belmont
B13-350-27
B13-350-33



Pediatric Aortic Clamps, Pediatric Vascular Clamps
 Kinder-Aortaklemmen, Kinder-Gefäßklemmen
 Pinzas aórticas pediátricas, Pinzas vasculares pediátricas
 Pincès-clamps pour aorte pédiatriques, Pincès vasculaires pédiatriques
 Pinze per aorta pediátriche, Pinze vascolari pediátriche



13

Atrauma

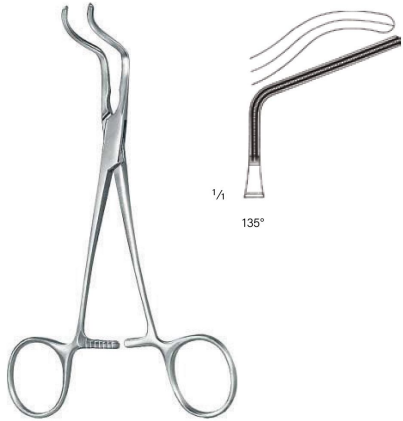

Subramanian-Miniature
B13-351-16
 16 cm / 6 3/8"

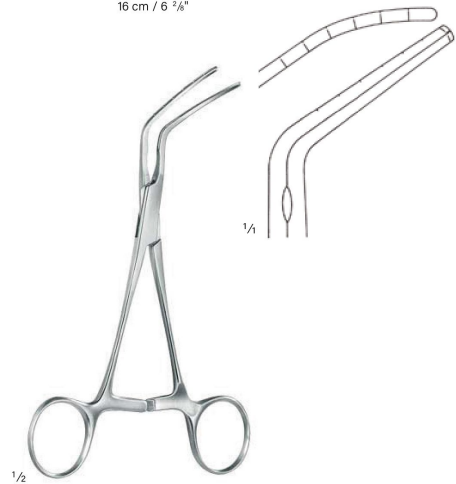

Subramanian
B13-352-16
 16 cm / 6 3/8"

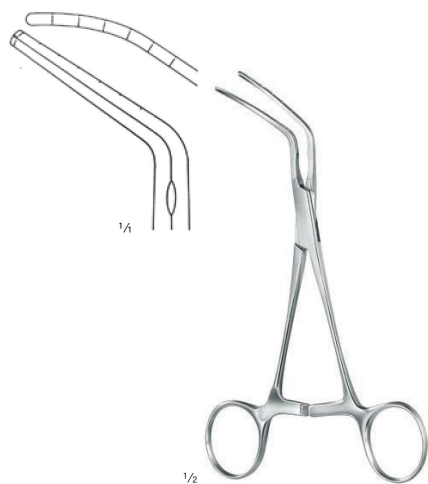

Subramanian
B13-353-16
 16 cm / 6 3/8"

Pediatric Vascular Clamps
 Kinder-Gefäßklemmen
 Pinzas vasculares pediátricas
 Pincès vasculaires pédiatriques
 Pinze vascolari pediátriche



13

Atrauma

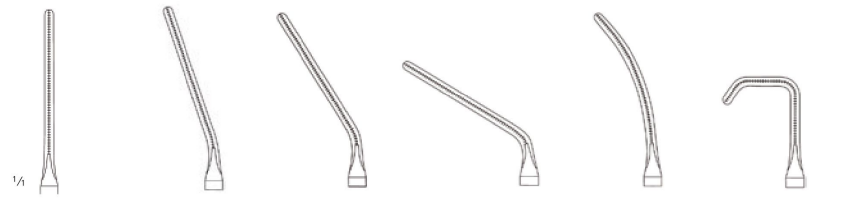

Fig. 1 B13-354-01 14 cm / 5 1/2"
Fig. 2 B13-354-02 14 cm / 5 1/2"
Fig. 3 B13-354-03 14 cm / 5 1/2"
Fig. 4 B13-354-04 14 cm / 5 1/2"
Fig. 5 B13-354-05 14 cm / 5 1/2"
Fig. 6 B13-354-06 13 cm / 5"

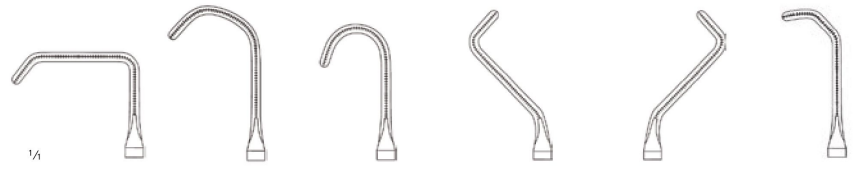

Fig. 7 B13-354-07 13 cm / 5"
Fig. 8 B13-354-08 14 cm / 5 1/2"
Fig. 9 B13-354-09 13 cm / 5"
Fig. 10 B13-354-10 14 cm / 5 1/2"
Fig. 11 B13-354-11 14 cm / 5 1/2"
Fig. 12 B13-354-12 14 cm / 5 1/2"

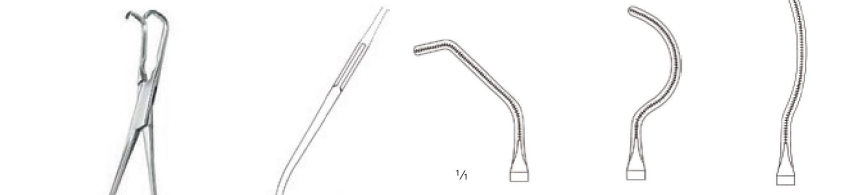

Fig. 13 B13-354-13 14 cm / 5 1/2"
Fig. 14 B13-354-14 14 cm / 5 1/2"
Fig. 15 B13-354-15 14 cm / 5 1/2"



De Bakey baby
B13-354-01
B13-354-15



Pediatric Vascular Clamps
 Kinder-Gefäßklemmen
 Pinzas vasculares pediátricas
 Pinces vasculaires pédiatriques
 Pinze vascolari pediatriche



13

Atrauma finoLine Ti St



De Bakery
B13-355-01
B13-356-01
 feine Zahnung
 delicate serration
 dentado fina
 denture fine
 dentatura delicata

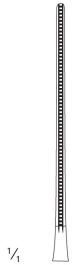

B13-355-01 St
B13-356-01 Ti
 13,5 cm / 5 1/8"



B13-355-02 St
B13-356-02 Ti
 13 cm / 5 1/8"

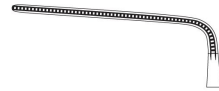

B13-355-03 St
B13-356-03 Ti
 10,5 cm / 4 1/8"



De Bakery
B13-355-04
B13-356-04
 feine Zahnung
 delicate serration
 dentado fina
 denture fine
 dentatura delicata

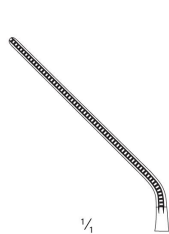

B13-355-04 St
B13-356-04 Ti
 12 cm / 4 3/8"



B13-355-05 St
B13-356-05 Ti
 13 cm / 5 1/8"

Neonatal Vascular Clamps
 Neonatal-Gefäßklemmen
 Pinzas vasculares para recién nacidos
 Pinces vasculaires pour nouveaux nés
 Pinze vascolari per neonati



13

Atrauma finoLine Ti St



De Bakery
B13-357-01
 10,5 cm / 4 1/8"
 sehr feine Zahnung
 very delicate serration
 dentado muy fina
 denture très fine
 dentatura molto delicata



De Bakery
B13-357-02
B13-357-03
 10,5 cm / 4 1/8"
 sehr feine Zahnung
 very delicate serration
 dentado muy fina
 denture très fine
 dentatura molto delicata

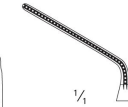

B13-357-02



B13-357-03



De Bakery
B13-357-04
B13-357-05
 10,5 cm / 4 1/8"
 sehr feine Zahnung
 very delicate serration
 dentado muy fina
 denture très fine
 dentatura molto delicata



B13-357-04



B13-357-05



Pediatric Vascular Clamps
 Kinder-Gefäßklemmen
 Pinzas vasculares pediátricas
 Pinces vasculaires pédiatriques
 Pinze vascolari pediatriche



13

Atrauma

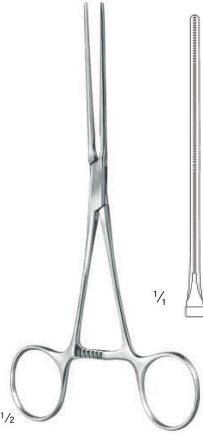

De Baakey baby
B13-358-16
 16,5 cm / 6 5/8"

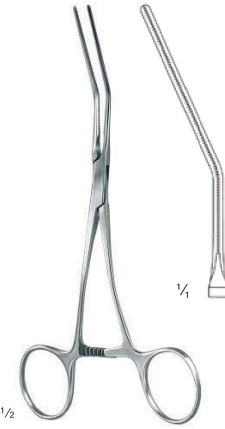

De Baakey baby
B13-359-16
 16,5 cm / 6 5/8"

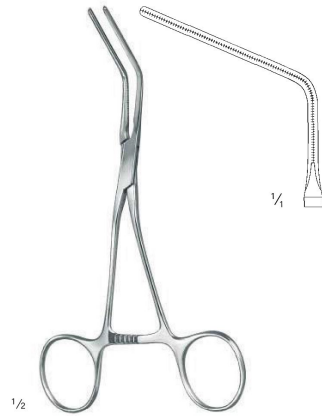

De Baakey baby
B13-360-15
 15,5 cm / 6"



De Baakey baby
B13-361-15
 15,5 cm / 6"



De Baakey baby
B13-362-16
 16 cm / 6 3/8"

123



13

Pediatric Vascular Clamps
 Kinder-Gefäßklemmen
 Pinzas vasculares pediátricas
 Pinces vasculaires pédiatriques
 Pinze vascolari pediatriche

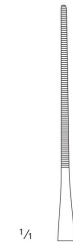

B13-363-01
 13 cm / 4 1/8"



B13-363-02
 12,5 cm / 5"



B13-363-03
 12 cm / 4 3/8"



B13-363-04
 11 cm / 4 3/8"



B13-363-05
 12 cm / 4 3/8"



B13-363-06
 12 cm / 4 3/8"



B13-363-07
 12 cm / 4 3/8"



B13-363-08
 12 cm / 4 3/8"



Castañeda
B13-363-01
B13-363-08



124



no one does it BETTER



Cell: 0092 323 9300123

Tel: 0092 52 3563378

URL: <https://bona-dent.com>

Email: info@bona-dent.com

Email: bonadent.mfg@gmail.com

Address:

Kacha Shahab Pura Road

Jeewan Pura, Sialkot (51310)

Pakistan.

