

MORE THAN YOU BELIEVE

• BRINGS
YOU MORE
POWER



NEURO+
SURGERY



An Era Of **evolution**

Bonadent

HAS THE REPUTATION OF BEING THE ONLY IN PAKISTAN THAT MANUFACTURES ITS OWN TOOLS FOR THE PRODUCTION OF ITS INSTRUMENTS.

Bonadent is a privately owned company providing personalized services and the finest in Surgical Instruments for over 25 years. Established in 1999, Our Company manufactures a wide range of Surgical, Dental and Veterinary Instruments.

All Instruments and devices of our product range are manufactured by well-trained and experienced skilled workers with special craftsmanship and by use of most modern machines and equipment. On this occasion we only use materials which meet our high standards. The CEO of Bonadent Manufacturing co, Mr. Muhammad Ibrahim brings with him a lifetime of knowledge about the world of surgical instruments.

This insight allows us to understand the needs of our customers in a way most other instrument companies are unable to do.

After becoming a competent oem service provider, cardiac has decided to introduce itself as the original source of high quality instrumentation to directly interact with some of the well-known brands around the world.

Wire Saws
Drahtsägen
Sierras de hilo
Fils-scies
Fili sega

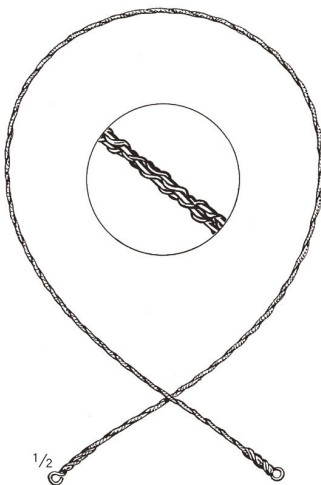

Gigli

B14-100-30
B14-100-70

B14-100-30
30 cm / 11 5/8"

B14-100-40
40 cm / 15 5/8"

B14-100-50
50 cm / 19 5/8"

B14-100-60
60 cm / 23 5/8"

B14-100-70
70 cm / 27 1/8"



Gigli

B14-101-01

Drahtsägen-Handgriff
Wire saw handle
Mango de gancho
Manche à crochet
Manico con uncino



De Martel

B14-102-33

33 cm / 13"
Einführinstrument
Wire saw guide
Conductor para sierras de hilo
Conducteur pour fils-scies
Introduttore

Skull Traction Tong

Schädelhalter
Estribos de tracción craneal
Pinces de traction crânienne
Pinze per trazione craniale



1/2

**Crutchfield
B14-103-01**

kleines Modell
small pattern
modelo pequeño
modèle petit
modello piccolo



1/2

**Crutchfield
B14-103-02**

mittleres Modell
medium pattern
modelo mediano
modèle moyen
modello medio



1/2

Ø 3,5 mm
B14-103-04
7 cm / 2 5/8"
Vorbohrer
Drill Point
Perforador
Alésoir
Alesatore



B14-103-02



Ø 5 mm
B14-103-05
7 cm / 2 5/8"
Vorbohrer
Drill Point
Perforador
Alésoir
Alesatore

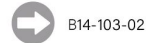

B14-103-02



1/2

B14-104-01
großes Modell
large pattern
modelo grande
modèle grand
modello grande

B14-104-10
Ersatzdorn
Spare Pin
Espina de repuesto
Pointe de rechange
Punta di ricambio



B14-104-01

Cranial Rongeurs

Schädelzangen
Pinzas sacabocados craneales
Pincas emporte-pièces crâniennes
Pinze per craniectomia



Dahlgren B14-105-19

19,5 cm / 7 5/8"
mit 3 Haken
with 3 hooks
con 3 ganchos
avec 3 crochets
con 3 ganci



De Vilbiss B14-106-21

21 cm / 8 2/8"
mit 2 Haken
with 2 hooks
con 2 ganchos
avec 2 crochets
con 2 ganci



Cone B14-107-22

22,5 cm / 8 7/8"
Schädelstanze
Cranial Punch
Pinza sacabocado craneal
Pince emporte-pièces crânienne
Pinza per craniectomia



Clips and Applying Forceps
 Clips und Anlegezangen
 Grapas y pinzas aplicadoras
 Clips et pinces pour appliquer
 Agrafes e pinze per applicare



Olivecrona-Toennis
B14-108-14

Klammerzange
 Clip Applying Forceps
 Pinza para colocar grapas
 Pince pour poser les agrafes en argent
 Pinza per applicare le agrafe di argento



McKenzie
B14-109-18

18,5 cm / 7 2/8"
 Klammerzange
 Clip Applying Forceps
 Pinza clipadora
 Pince pour poser les agrafes
 Pinza per applicare le agrafe



Kölner
B14-110-00

Kopfhautklammer
 Scalp Clip
 Grapa para cuero cabelludo
 Agrafes pour cuir chevelu
 Pinze per il cuoio capelluto
 VE = 50 Stück
 SU = 50/pack
 UV = 50 piezas
 UC = 50 unités
 UV = 50 pezzi



Raney
B14-111-00

Kopfhautklammer
 Scalp Clip
 Grapa para cuero cabelludo
 Agrafes pour cuir chevelu
 Pinze per il cuoio capelluto



Raney
B14-112-00

15,5 cm / 6"
 Anlege- und Abnehmzange
 Applying/Removal Forceps
 Pinza para aplicar y quitar agrafes
 Pince pour appliquer et enlever les
 clips hémostatiques du cuir
 Pinza per applicare e togliere le agrafe
 emostatiche al cuoio capelluto

B14-111-00



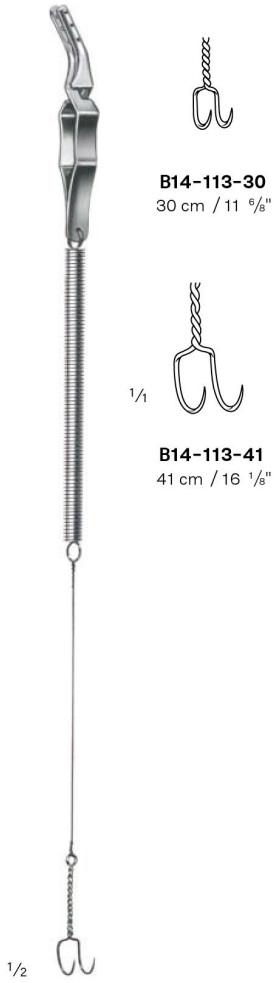

B14-113-30
 30 cm / 11 ⁵/₈"

1/1

B14-113-41
 41 cm / 16 ¹/₈"

1/2

Yasargil

B14-113-30

B14-113-41

Galeahaken
 Galea hook
 Gancho Galea
 Ecarteur Galea
 Divaricatore Galea

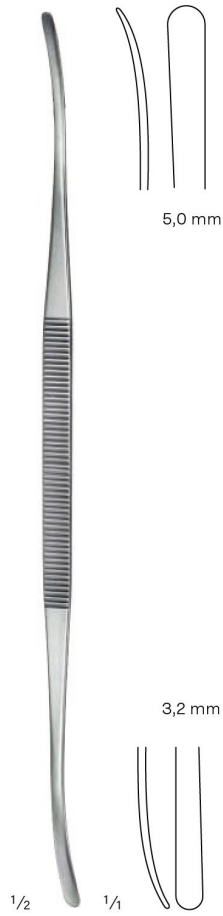

5,0 mm

3,2 mm

1/2

1/1

Toennis

B14-114-24

24 cm / 9 ⁴/₈"

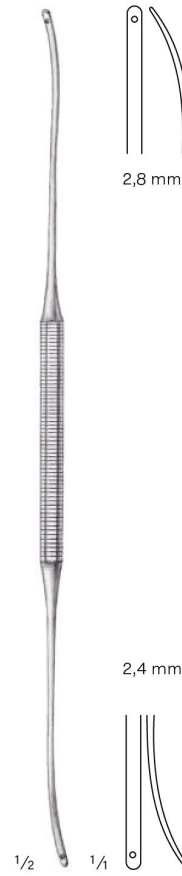

2,8 mm

2,4 mm

1/2

1/1

Olivecrona

B14-115-24

24 cm / 9 ⁴/₈"



2,4 mm

2,7 mm

1/2

1/1

Olivecrona

B14-116-18

18 cm / 7 ¹/₈"



Dissectors
 Dissektoren
 Disecadores
 Dissecteurs
 Dissettori

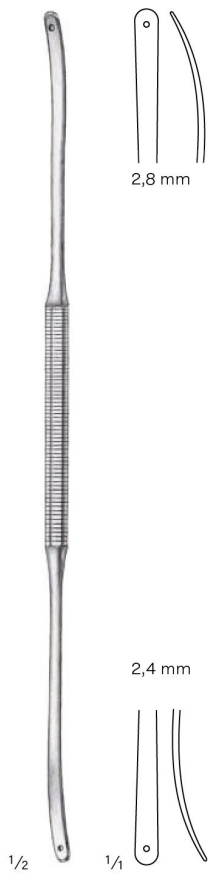

Olivecrona
B14-117-24
 24 cm / 9 4/8"



Olivecrona
B14-118-20
 20 cm / 7 7/8"



Sachs
B14-119-20
 20,5 cm / 8 1/8"



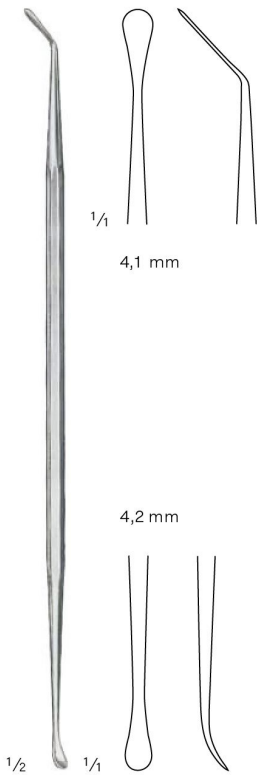

Milligan
B14-120-22
 22 cm / 8 5/8"

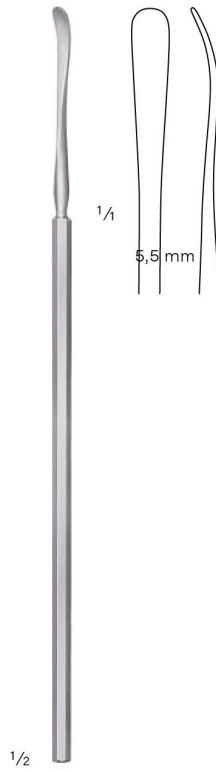

Davis
B14-121-21
 21,5 cm / 8 1/2"

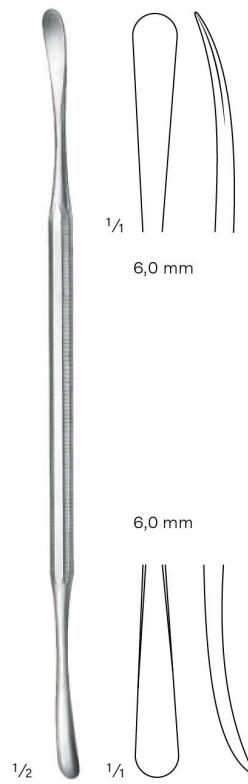

B14-122-22
 22 cm / 8 5/8"



Davis
B14-123-24
 24,5 cm / 9 5/8"

Dissectors
 Dissektoren
 Discadores
 Dissecteurs
 Dissettori

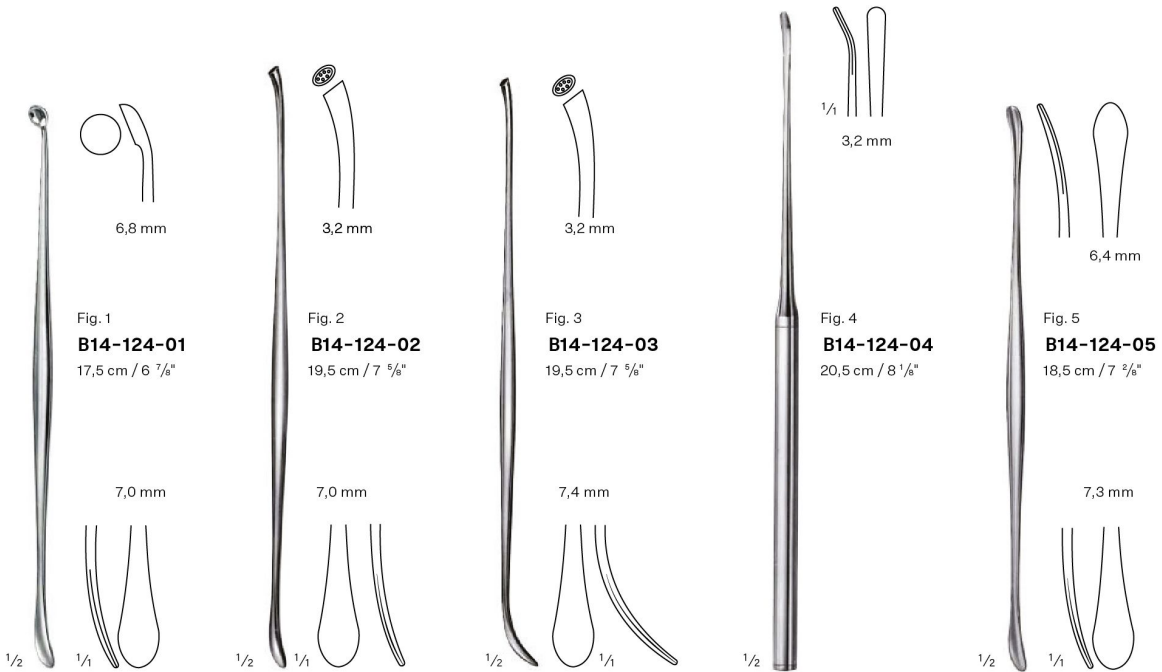

Penfield
 B14-124-01
 B14-124-05

Self-Retaining Retractors, for Skull Mounting

Retraktoren zur Fixation am Schädel

Separadores para la fijación del cráneo

Ecarteurs autofixant au crâne

Autofissator per retrattori, per il supporto del cranio



Leyla B14-125-01	Selbsthaltender Hirnspatel mit 1 Spannarm, komplett, bestehend aus:	Self-retaining brain retractor with 1 flexible arm, complete, consisting of:	Separador automático para el cerebro con 1 brazo, completo, compuesto de:	Ecarteur autofixant au crâne avec 1 bras complet, composé de:	Autofissatore per retrattore cervicale con 1 braccio, completo, composto da:
B14-125-03	1 Spannarm, flexibel	Flexible arm	Brazo, flexible	Bras flexible	Braccio flessibile
B14-125-04	1 Fixiervorrichtung für 1 Spannarm	Fixation base for 1 arm	Fijador para 1 brazo	Base de fixation pour 1 bras	Base di fissaggio per 1 braccio
B14-125-08	1 Spatelhalter für flache Spatel	Support for flat brain spatulas	Porta-espátulas para espátulas planas	Support pour spatules plats	Supporto per spatole cervicali piatte

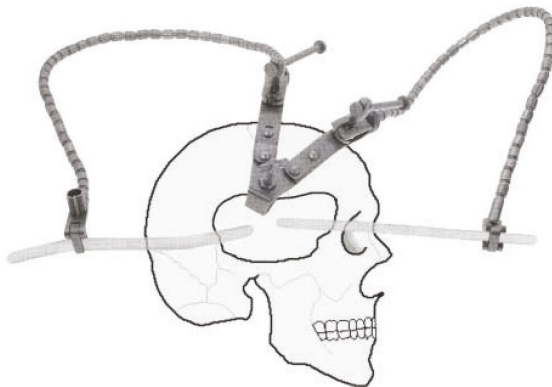

Leyla B14-125-02	Selbsthaltender Hirnspatel mit 2 Spannarmen, komplett, bestehend aus:	Self-retaining brain retractor with 2 arms, complete, consisting of:	Separador automático para el cerebro con 2 brazos, completo, compuesto de:	Ecarteur autofixant au crâne avec 2 bras complet, composé de:	Autofissatore per retrattore cervicale con 2 bracci, completo, composto da:
B14-125-03	2 Spannarme, flexibel	Flexible arms	Brazos, flexibles	Bras, flexibles	Bracci, flessibili
B14-125-05	1 Fixiervorrichtung für 2 Spannarme	Fixation base for 2 arms	Fijador para 2 brazos	Base de fixation pour 2 bras	Base di fissaggio per 2 bracci
B14-125-08	2 Spatelhalter für flache Spatel	Supports for flat brain spatulas	Porta-espátulas para espátulas planas	Supports pour spatules plats	Supporti per spatole cervicali piatte



Accessories for Leyla Self Retaining Retractors
 Zubehör zu Leyla-Reraktoren
 Accesorios para separadores automáticos de Leyla
 Accessoires pour écarteurs autofixants de Leyla
 Accessori per autofissatori per retrattori di Leyla



**Leyla
B14-125-03**

Spannarm zum Aufstecken auf Kupplungsköpfe C14-125-15/ C14-125-16 und Fixiervorrichtungen C14-125-04 / C14-125-05 / C14-125-06

Flexible arm for attaching coupling heads C14-125-15/ C14-125-16 and fixation bases C14-125-04 / C14-125-05 / C14-125-06

Brazo para colocar sobre el acoplamiento C14-125-15/ C14-125-16 y los fijadores C14-125-04 / C14-125-05 / C14-125-06

Bras flexible pour fixation aux têtes d'accouplement C14-125-15/ C14-125-16 et base de fixation C14-125-04 / C14-125-05 / C14-125-06

Braccio flessibile per il fissaggio delle teste di accoppiamento C14-125-15/ C14-125-16 e le basi di fissaggio C14-125-04 / C14-125-05 / C14-125-06



**Leyla
B14-125-04**

Fixiervorrichtung für 1 Spannarm C14-125-03, zum Festschrauben am Schädel

Fixation base for 1 flexible arm C14-125-03, for skull mounting

Fijador para 1 brazo C14-125-03, para atornillar al cráneo

Base de fixation pour 1 bras C14-125-03, pour fixer au crâne

Base di fissaggio per 1 braccio flessibile C14-125-03, per il supporto del cranio



**Leyla
B14-125-05**

Fixiervorrichtung für 2 Spannarme C14-125-03, zum Festschrauben am Schädel

Fixation base for 2 flexible arms C14-125-03, for skull mounting

Fijador para 2 brazos C14-125-03, para atornillar al cráneo

Base de fixation pour 2 bras C14-125-03, pour fixer au crâne

Base di fissaggio per 2 bracci flessibili C14-125-03 per il supporto del cranio



**Leyla
B14-125-06**

Fixiervorrichtung für 1 Spannarm C14-125-03, zum Festschrauben an Rohrteilen bis Ø 16 mm

Fixation base for 1 flexible arm C14-125-03, for mounting to bars up to Ø 16 mm

Fijador para 1 brazo C14-125-03, para atornillar a tubos hasta Ø 16 mm

Base de fixation pour 1 bras C14-125-03, pour fixer aux tubes jusqu'à Ø 16 mm

Base di fissaggio per 1 braccio flessibile C14-125-03, per il supporto di asta di raccordo da Ø 16 mm



**Leyla
B14-125-07**

Spatelhalter mit Rundschaft bis Ø 5,5 mm, zur Befestigung am Spannarm C14-125-03

Support for brain spatulas with round shaft up to Ø 5,5 mm, fixation to flexible arm C14-125-03

Porta-espátula con vástago redondo hasta Ø 5,5 mm, para sujetarlo al brazo C14-125-03

Support pour spatules avec tiges ronds jusqu'à Ø 5,5 mm, pour fixation au bras C14-125-03

Supporto per spatole craniali con diametro asse Ø 5,5 mm, fissato al braccio flessibile C14-125-03



**Leyla
B14-125-08**

Spatelhalter für flache Spatel zur Befestigung am Spannarm C14-125-03

Support for flat brain spatulas, fixation to flexible arm C14-125-03

Porta-espátula para espátulas planas, para sujetarlo al brazo C14-125-03

Support pour tiges plats, pour fixation au bras C14-125-03

Supporto per spatole cervicali piate, fissato al braccio flessibile C14-125-03



Self-Retaining Retractors, Fixation to Operating Table

Retraktoren zur Fixation am OP-Tisch

Separadores para la fijación a la mesa de operaciones

Ecarteurs pour fixation à la table d'opération

Autofissatori per retrattori, da fissare alla tavola operatoria



Leyla C14-125-11	Selbsthaltender Hirnspatel mit 1 Spannarm, komplett, bestehend aus:	Self-retaining brain retractor with 1 flexible arm, complete, consisting of:	Separador automático para el cerebro con 1 brazo, completo, compuesto de:	Ecarteur du cerveau auto-fixant avec 1 bras complet, composé de:	Autofissatore per retrattori cervicali con 1 braccio flessibile, composto da:
B14-125-13	1 Kugelgelenkkloben	Ball and socket joint	Articulación esférica	Articulation sphérique	Giunto a sfera ad incastro
B14-125-14	1 Haltearm	Holding rod	Brazo de apoyo	Bras de fixation	Porta-asta
B14-125-15	1 Kupplungskopf	Coupling head	Acoplamiento	Tête d'accouplement	Testa accoppiamento
B14-125-03	1 Spannarm	Flexible arm	Brazo	Bras flexible	Braccio flessibile
B14-125-07	1 Spatelhalterung für Spatel mit rundem Griff	Support, for brain spatulas with round shaft	Porta-espátula para espátulas con mangos redondos	Support pour spatules avec manches ronds	Supporto per spatole craniali con albero rotondo



Leyla B14-125-12	Selbsthaltender Hirnspatel mit 2 Spannarmen, komplett, bestehend aus:	Self-retaining brain retractor with 2 flexible arms, complete, consisting of:	Separador automático para el cerebro con 2 brazos, completo, compuesto de:	Ecarteur du cerveau auto-fixant avec 2 bras complet, composé de:	Autofissatore per retrattori cervicali con 2 bracci flessibili, composto da:
B14-125-13	1 Kugelgelenkkloben	Ball and socket joint	Articulación esférica	Articulation sphérique	Giunto a sfera ad incastro
B14-125-14	1 Haltearm	Holding rod	Brazo de apoyo	Bras de fixation	Porta-asta
B14-125-16	2 Kupplungsköpfe	Coupling heads	Acoplamientos	Têtes d'accouplement	Teste accoppiamento
B14-125-03	2 Spannarme	Flexible arms	Brazos	Bras flexibles	Bracci flessibili
B14-125-08	1 Spatelhalterung, für flache Spatel	Support, for flat brain spatulas	Porta-espátula, para espátulas planas	Support pour spatules plats	Supporto per spatole craniali piatte
B14-125-07	1 Spatelhalterung, für Spatel mit rundem Griff	Support, for brain spatulas with round shaft	Porta-espátula para espátulas con mangos redondos	Support pour spatules avec manches ronds	Supporto per spatole craniali con albero rotondo



Accessories for Leyla Retractors

Zubehör zu Leyla-Reraktoren

Accesorios para separadores automáticos de for Leyla

Accessoires pour écarteurs Leyla

Accessori per autofissatori per retrattori di Leyla



Leyla

B14-125-13

Kugelgelenkkloben, zur Befestigung des Haltearms C14-125-14 an OP-Tisch-Schienen

Ball and socket joint, for fixation of holding rod C14-125-14 to pole of operating table

Articulación esférica, para sujetar el brazo de apoyo C14-125-14 sobre la mesa de operaciones

Articulation sphérique pour fixation du bras C14-125-14 aux bandes de la table d'opération

Giunto a sfera ad incastro, per il fissaggio dell'asta C14-125-14 all'estremità del tavolo operatorio

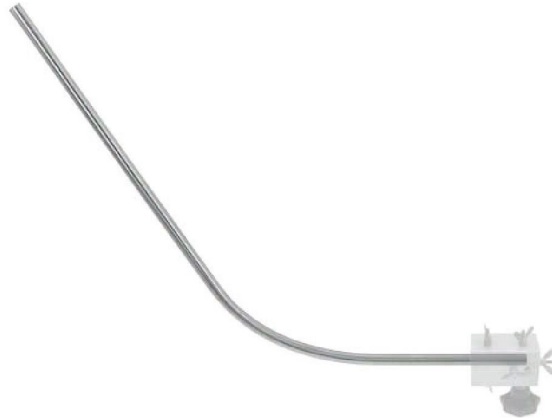

Leyla

B14-125-14

Haltearm zur Fixation im Kugelgelenkkloben C14-125-13 und zur Aufnahme der Kupplungsköpfe C14-125-15/ C14-125-16

Holding rod for fixation in ball and socket joint C14-125-13 and to take coupling heads C14-125-15/ C14-125-16

Brazo de apoyo para fijar en la articulación esférica C14-125-13 y para recoger los acoplamientos C14-125-15/ C14-125-16

Bras d'appui pour fixer dans l'articulation sphérique C14-125-13 pour prendre les têtes d'accouplement C14-125-15/ C14-125-16

Porta asta per il fissaggio al giunto a sfera C14-125-13 e per prendere le teste di accoppiamento C14-125-15/ C14-125-16



Leyla

B14-125-15

Kupplungskopf zur Aufnahme von 1-5 Spannarmen C14-125-03

Coupling head to take 1-5 flexible arms C14-125-03

Acoplamiento para sujetar 1-5 brazos C14-125-03

Tête d'accouplement pour prendre 1-5 bras flexibles C14-125-03

Testa accoppiamento per prendere 1-5 bracci flessibili C14-125-03



Leyla

B14-125-16

Kupplungskopf, drehbar, in allen Ebenen fixierbar, zur Aufnahme von 1 Spannarm C14-125-03

Coupling head, turnable, can be fixed in any position, to take 1 flexible arm C14-125-03

Acoplamiento, girable y se puede fijar en todas las posturas para sujetar un brazo C14-125-03

Tête d'accouplement, rotative peut être fixée en toute position, pour tenir 1 bras flexible C14-125-03

Testa accoppiamento, girevole, può essere fissata in qualsiasi posizione, supporta 1 braccio flessibile C14-125-03



Spatulas
 Spatel
 Espátulas
 Spatules
 Spatole



1/2

B14-126-08	155 x 8 mm
B14-126-11	155 x 11 mm
B14-126-14	155 x 14 mm
B14-126-17	155 x 17 mm

Heifetz
B14-126-08
B14-126-17
 biegsam
 malleable
 maleable
 malléable
 malleabile



1/2



1/4

B14-127-14	200 x 14 mm
B14-127-17	200 x 17 mm
B14-127-20	200 x 20 mm

Heifetz
B14-127-14
B14-127-20
 biegsam
 malleable
 maleable
 malléable
 malleabile

Hooks
Haken
Ganchos
Crochets
Uncini



Groningen
B14-128-26
26,5 cm / 10 3/8"



Groningen
B14-129-26
26,5 cm / 10 3/8"



Cushing
B14-130-19
B14-130-28



Cushing
B14-131-19
B14-131-28



Smithwick
B14-132-16
B14-132-21



Hooks
Haken
Ganchos
Crochets
Uncini



B14-133-20
stumpf
blunt
romo
mousse
smusso

Adson
B14-133-20
B14-134-20
20 cm / 7 7/8"

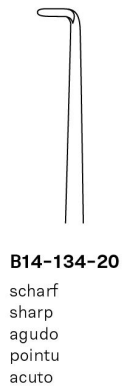

B14-134-20
scharf
sharp
agudo
pointu
acuto



Graham
B14-135-16
16,5 cm / 6 4/8"



Sachs
B14-136-17
17 cm / 6 5/8"



Hooks
 Haken
 Ganchos
 Crochets
 Uncini



B14-137-19
B14-138-19
 19 cm / 7 ⁴/₈"
 Mikro-Häkchen
 Micro hooklet
 Micro-gancho
 Micro-crochet
 Micro-uncino

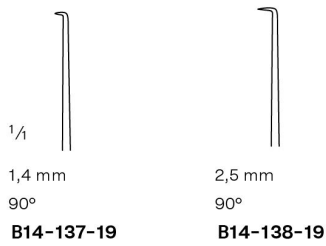

1,4 mm
 90°
B14-137-19

2,5 mm
 90°
B14-138-19



Frazier
B14-139-13
B14-139-18

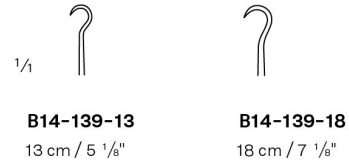

B14-139-13
 13 cm / 5 ¹/₈"

B14-139-18
 18 cm / 7 ¹/₈"



Micro Scissors
 Mikro-Scheren
 Micro-Tijeras
 Micro-Ciseaux
 Micro-Forbici



B14-140-01

9 mm



B14-140-02

12 mm

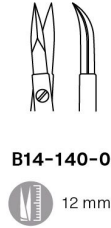

B14-140-03

12 mm

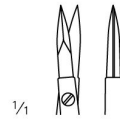

B14-140-04

12 mm

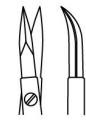

B14-140-05

12 mm

Vannas
B14-140-01
B14-140-03
 12 cm / 4 7/8"

Vannas
B14-140-04
B14-140-05
 16 cm / 6 2/8"

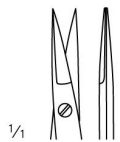

B14-140-10

12 mm



B14-140-11

12 mm



12 mm

Millesi
B14-140-10
B14-140-11
 16 cm / 6 2/8"

Jacobson
B14-140-15
 18,5 cm / 7 2/8"

Micro Scissors
 Mikro-Scheren
 Micro-Tijeras
 Micro-Ciseaux
 Micro-Forbici



1/2

Yasargil
 B14-140-20
 B14-140-24

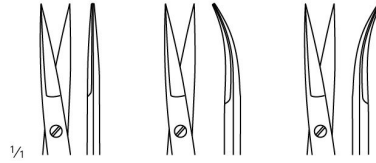

	15 mm	15 mm	15 mm
16,5 cm / 6 7/8"	B14-140-20	B14-140-21	
20 cm / 7 7/8"	B14-140-22	B14-140-23	B14-140-24



1/2

Yasargil
 B14-140-25
 B14-140-33

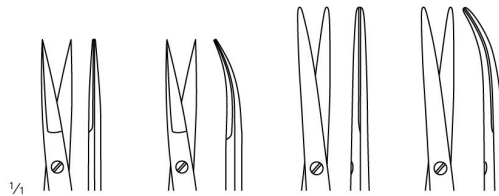

	A	A	D	D
20 cm / 7 7/8"	15 mm	15 mm	B14-140-30	B14-140-31
22,5 cm / 8 7/8"	B14-140-25	B14-140-26	B14-140-33	B14-140-32
24,5 cm / 9 5/8"		B14-140-28		



Micro Scissors
 Mikro-Scheren
 Micro-Tijeras
 Micro-Ciseaux
 Micro-Forbici



1/2

Nagel
B14-140-40
B14-140-42
 20 cm / 7 7/8"



1/4

45°
B14-140-40



1/4

45°
B14-140-41

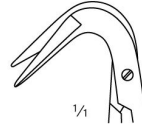

1/4

135°
B14-140-42

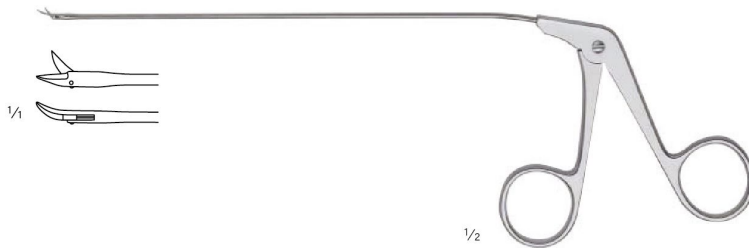

1/2

Fahlbusch
B14-140-50
 16,5 cm / 6 4/8"

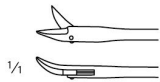

1/4

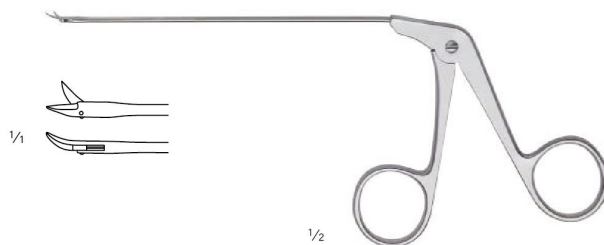

1/2

Caspar
B14-140-60
 11,5 cm / 4 4/8"



1/4

Micro Forceps
 Mikro-Pinzetten
 Micro-Pinzas
 Micro-Pinces
 Micro-Pinze



Jacobson
B14-141-01
 18 cm / 7 1/8"
 ohne Sperre
 w/o ratchet
 sin trinquete
 sans cran d'arrêt
 senza arresto



Jacobson
B14-141-02
 18 cm / 7 1/8"
 mit Sperre
 with ratchet
 con trinquete
 avec cran d'arrêt
 con arresto



B14-141-10
 20 cm / 7 7/8"

B14-141-11
 20 cm / 7 7/8"

B14-141-12
 22,5 cm / 8 7/8"

B14-141-13
 22,5 cm / 8 7/8"

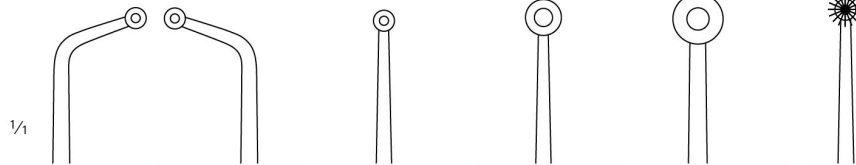

	Samii	Samii	Yasargil-Samii	Yasargil-Samii	Yasargil-Samii	Yasargil
∅	3.0 mm	3.0 mm	3.0 mm	5.0 mm	7.0 mm	3.0 mm
16,5 cm / 6 4/8"						B14-142-20
23 cm / 9"	B14-142-01	B14-142-02				
24 cm / 9 4/8"			B14-142-10	B14-142-11	B14-142-12	

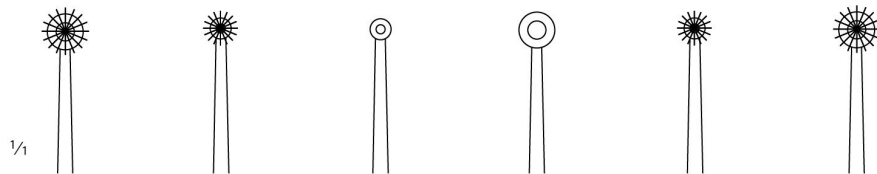

	Yasargil	Yasargil	Yasargil	Yasargil	Yasargil	Yasargil
∅	5.0 mm	3.0 mm	3.0 mm	5.0 mm	3.0 mm	5.0 mm
16,5 cm / 6 4/8"	B14-142-21					
20 cm / 7 7/8"		B14-142-22				
22 cm / 8 5/8"			B14-142-23	B14-142-24	B14-142-25	B14-142-26

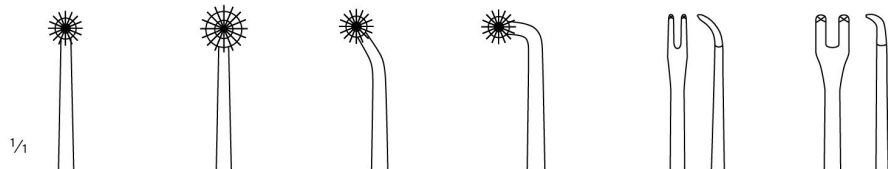

	Heifetz	Heifetz	Yasargil	Yasargil	Yasargil	Yasargil
∅			45°	90°		
	∅ 3.0 mm	∅ 5.0 mm	∅ 3.0 mm	∅ 3.0 mm	3.0 mm	5.0 mm
22 cm / 8 5/8"	B14-142-30	B14-142-31	B14-142-40	B14-142-41	B14-142-50	B14-142-51



B14-142-01
B14-142-78

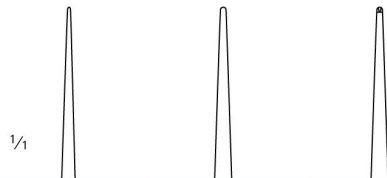

	Yasargil	Yasargil	Yasargil
∅	0.6 mm	0.9 mm	
			1:2
18 cm / 7 1/8"	B14-142-70	B14-142-71	B14-142-72
20 cm / 7 7/8"	B14-142-73	B14-142-74	
22 cm / 8 5/8"	B14-142-75	B14-142-76	
24 cm / 9 4/8"	B14-142-77	B14-142-78	



Micro Forceps

Mikro-Pinzetten
Micro-Pinzas
Micro-Pinces
Micro-Pinze



1/2

Hunt
B14-142-60
B14-142-61
20 cm / 7 7/8"



1/4

5 mm

B14-142-60
abgewinkelt
angled
acodado
coudé
angolato



5 mm

B14-142-61
bajonett
bayonet
bayoneta
baïonnette
baionetta





1/4

8 mm
B14-143-01



5 mm
B14-143-02

Yasargil

B14-143-01
B14-143-02

20 cm / 7 7/8"
 Tumorgabel
 Tumor fork
 Horquilla para tumor
 Fourche à tumeurs
 Forchetta per tumore

1/2



1/4

18 mm

mit Schutzhülse
 with protection sleeve
 con tapa de protección
 avec écrou-chapeau
 con copericho di protezione

B14-143-03

18,5 cm / 7 3/8"
 Gewebekralle
 Tissue forceps
 Pinza para tejido
 Pince à tissus
 Pinze per tessuto

1/2

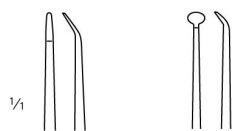

1/4

Ø	Samii	Samii
1,0 mm	B14-144-01	
1,5 mm	B14-144-02	B14-144-09
2,0 mm	B14-144-03	
2,5 mm	B14-144-04	
3,0 mm	B14-144-05	B14-144-10
3,5 mm	B14-144-06	
4,0 mm	B14-144-07	
4,5 mm		B14-144-11
5,0 mm	B14-144-08	
6,0 mm		B14-144-12

Samii

B14-144-01
B14-144-12

23 cm / 9"
 Tumormesser
 Tumor knife
 Bisturí para tumor
 Couteau à tumeurs
 Coltello per tumore

1/2



Caspar
B14-145-01
B14-145-10
 Mikro-Dissektor
 Micro-dissector
 Micro-dissecteur
 Micro-dissettore

	gerade straight recto droit diritto	gerade straight recto droit diritto	bajonett bayonet bayoneta baïonnette baionetta	bajonett bayonet bayoneta baïonnette baionetta
∅	4,5 mm	1,0 mm	4,5 mm	2,0 mm
20 cm / 7 7/8"		B14-145-04		
23 cm / 9"	B14-145-01		B14-145-02	B14-145-03

	bajonett bayonet bayoneta baïonnette baionetta	bajonett bayonet bayoneta baïonnette baionetta	Fadengabel Suture fork Horquilla de sutura Pousse-fil Forchetta da sutura	
∅	1,0 mm	1,0 mm		
20 cm / 7 7/8"	B14-145-05	B14-145-06		
23 cm / 9"			B14-145-10	



Samii
B14-146-01
 Lanzettenmesser
 Lancet knife
 Cuchillo de lanceta
 Couteau lancéolaire
 Coltello lanceolato

B14-146-10
B14-146-30
 Mikrogefäßmesser
 Micro vascular knife
 Micro-cuchillo vascular
 Micro-couteau vasculaire
 Micro-coltello vascolare

	gerade straight recto droit diritto	bajonett bayonet bayoneta baïonnette baionetta	bajonett bayonet bayoneta baïonnette baionetta	bajonett bayonet bayoneta baïonnette baionetta
	Samii	Koos	Koos	Koos
∅	1,8 mm			
18,5 cm / 7 2/8"		B14-146-10	B14-146-11	B14-146-12
23 cm / 9"	B14-146-01			

	bajonett bayonet bayoneta baïonnette baionetta	bajonett bayonet bayoneta baïonnette baionetta	bajonett bayonet bayoneta baïonnette baionetta	gerade straight recto droit diritto
	Koos	Yasargil	Yasargil	Jacobson
18,5 cm / 7 2/8"	B14-146-13	B14-146-20	B14-146-21	B14-146-30





1/2

Yasargil
B14-147-01
B14-147-04

Fadenführer
 Suture guide
 Pinza porta-suturas
 Pince guide-fil
 Pinze porta-filo

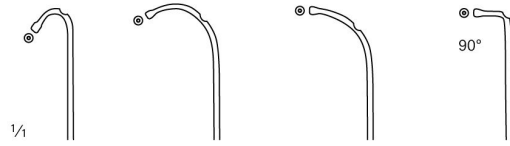

	gebogen curved curvo courbé curvo	gebogen curved curvo courbé curvo	gebogen curved curvo courbé curvo	gebogen curved curvo courbé curvo
∅	1,5 mm	1,5 mm	1,5 mm	1,5 mm
18,5 cm / 7 2/8"	B14-147-01	B14-147-02	B14-147-03	B14-147-04



1/2

Yasargil
B14-148-01
B14-148-20

Mikro-Raspatorium
 Micro raspatory
 Micro-raspador
 Micro-raspatoire
 Micro-raspatore

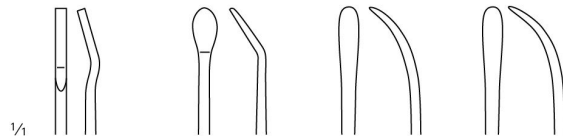

	gerade straight recto droit diritto	gerade straight recto droit diritto	gerade straight recto droit diritto	gerade straight recto droit diritto
	1,4 mm	4,0 mm	3,0 mm	3,9 mm
18,5 cm / 7 2/8"	B14-148-01	B14-148-02	B14-148-03	B14-148-04

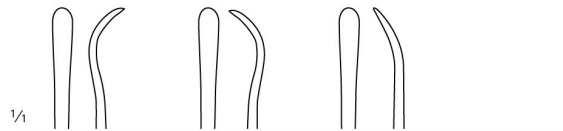

	bajonett bayonet bayoneta baionnette baionetta	bajonett bayonet bayoneta baionnette baionetta	bajonett bayonet bayoneta baionnette baionetta	
	3,0 mm	3,0 mm	3,0 mm	
18,5 cm / 7 2/8"	B14-148-05	B14-148-06	B14-148-07	

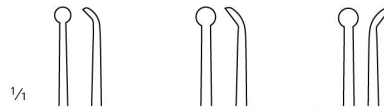

	gerade straight recto droit diritto	gerade straight recto droit diritto	bajonett bayonet bayoneta baionnette baionetta	
	2,5 mm	3,0 mm	3,0 mm	
23 cm / 9"	B14-148-10	B14-148-11	B14-148-20	

Micro instruments
 Mikro-Instrumente
 Micro-instrumentos
 Micro instruments
 Micro-strumenti



14



1/2

Yasargil
B14-149-01
B14-149-13
 Mikro-Dissektor
 Micro dissector
 Micro-dissector
 Micro-dissecteur
 Micro-dissetto

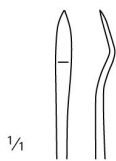

1/1

	gerade straight recto droit diritto
	2,6 mm
18,5 cm / 7 2/8"	B14-149-01

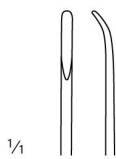

1/1

	gerade straight recto droit diritto	gerade straight recto droit diritto	bajonett bayonet bayoneta baïonnette baionetta	bajonett bayonet bayoneta baïonnette baionetta
	2,2 mm	2,2 mm	2,2 mm	2,0 mm
23 cm / 9"	B14-149-10	B14-149-12	B14-149-11	B14-149-13



26



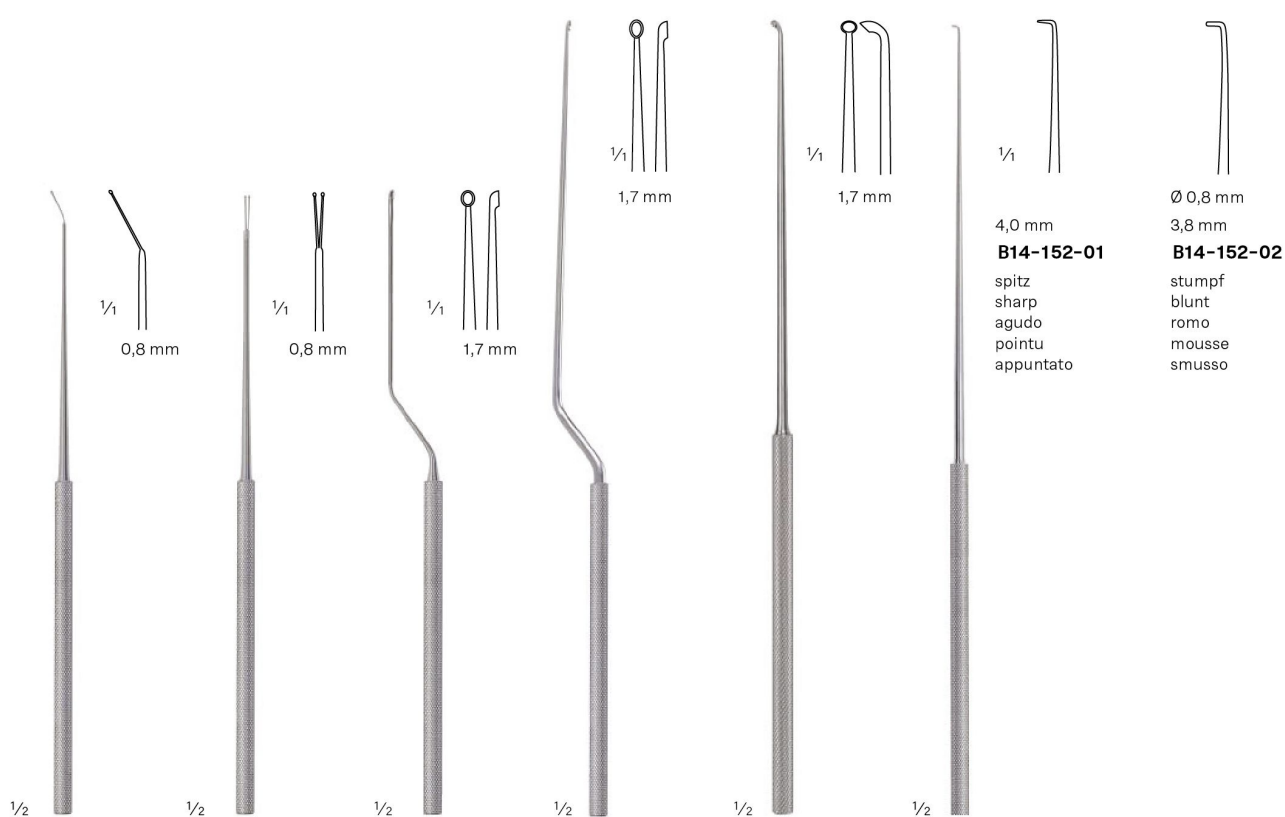

Ø 0,8 mm
 3,8 mm
B14-152-02
 stumpf
 blunt
 romo
 mousse
 smusso

4,0 mm
B14-152-01
 spitz
 sharp
 agudo
 pointu
 appuntato

1/1
 1,7 mm

1/1
 1,7 mm

1/1
 1,7 mm

1/1
 0,8 mm

1/1
 0,8 mm

Jacobson
B14-150-01
 18,5 cm / 7 2/8"
 Knopfsonde
 Button probe
 Sonda abotonada
 Sonde bouton
 Sonda bottonuta

Jacobson
B14-150-02
 18,5 cm / 7 2/8"
 Doppelsonde
 Probe, double
 Sonda doble
 Sonde double
 Sonda doppia

Yasargil
B14-151-01
 18,5 cm / 7 2/8"
 Mikro-Löffel
 Micro curette
 Micro-cucharilla
 Micro-curette
 Micro-curetta

B14-151-10
 23 cm / 9"
 Mikro-Löffel
 Micro curette
 Micro-cucharilla
 Micro-curette
 Micro-curetta

B14-151-11
 23 cm / 9"
 Mikro-Löffel
 Micro curette
 Micro-cucharilla
 Micro-curette
 Micro-curetta

B14-152-01
B14-152-02
 23 cm / 9"
 Durahaken
 Dura Hook
 Gancho para duramadre
 Crochet pour dure-mère
 Uncino per dura-madre



B14-153-01
B14-153-04
 Mikro-Häkchen
 Micro hooklet
 Micro-gancho
 Micro-crochet
 Micro-uncino

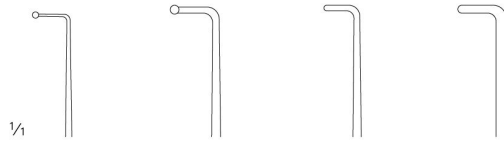

	Krayenbühl	Krayenbühl	Krayenbühl	Krayenbühl
∅	0,6 mm	1,1 mm	0,6 mm	0,8 mm
	90°	90°	90°	90°
	3,3 mm	4,5 mm	3,2 mm	3,2 mm
19 cm / 7 4/8"	B14-153-01	B14-153-02	B14-153-03	B14-153-04



B14-154-05
B14-154-11
 Mikro-Häkchen
 Micro hooklet
 Micro-gancho
 Micro-crochet
 Micro-uncino

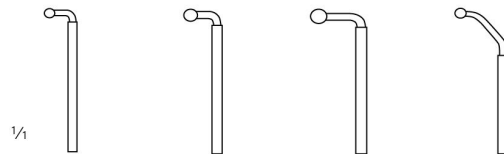

	Caspar	Caspar	Caspar	Caspar
∅	1,8 mm	2,0 mm	2,5 mm	1,8 mm
	90°	90°	90°	45°
	5 mm	7 mm	9 mm	11 mm
24,5 cm / 9 9/8"	B14-154-05	B14-154-07	B14-154-09	B14-154-11



Lamina Spreaders

Wirbelkörperspreizer
Separadores para cuerpos vertebrales
Ecarteurs pour corps vertébraux
Separatori per vertebre



Cloward
B14-155-16
16 cm / 6 2/8"

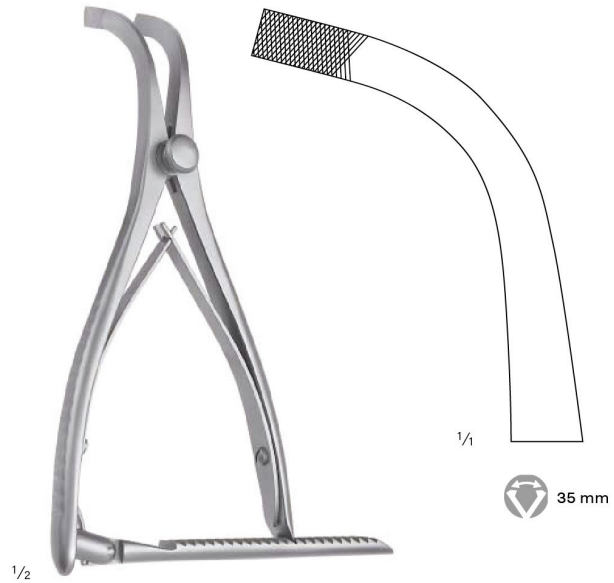

Cloward
B14-156-16
16 cm / 6 2/8"

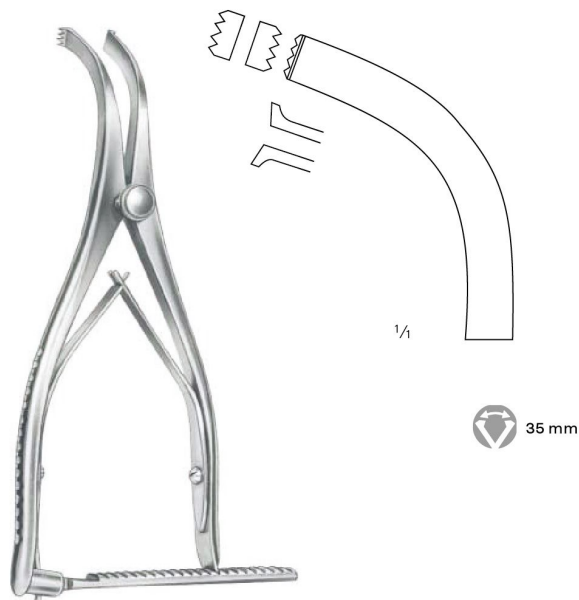

Inge
B14-157-16
16 cm / 6 2/8"

Lamina Spreaders

Wirbelkörperspreizer
Separadores para cuerpos vertebrales
Ecarteurs pour corps vertébraux
Separatori per vertebre



14



1/2

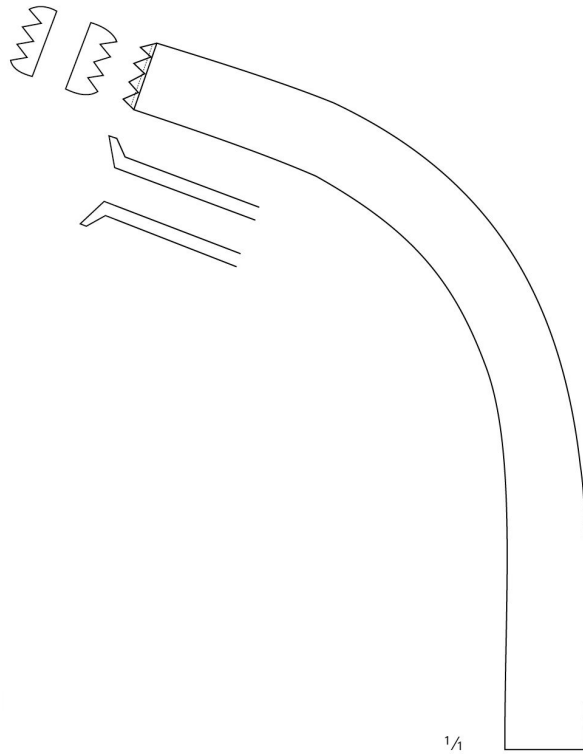

1/4



Inge

B14-158-25

25,5 cm / 10 "

30

Laminectomy Punches

Laminektomiestanzen
Pinzas cortantes para laminectomia
Pinces emporte-pièces à laminectomie
Pinze taglianti per laminectomia

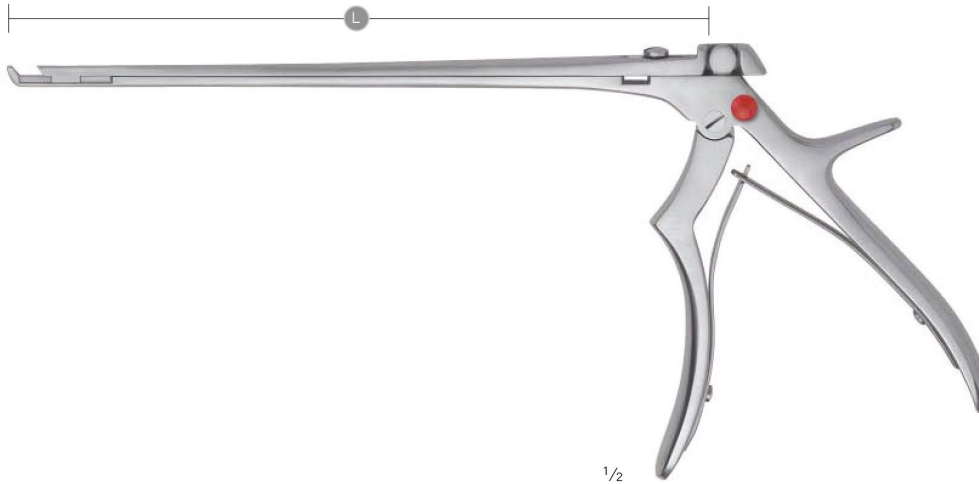

Ferris-Smith-Kerrison

B14-159-01

B14-160-48

Stanze mit Auswerfer, zerlegbar
Punch, with ejector, detachable
Perforador con eyector, desmontable
Perforateur avec éjecteur, démontable
Pinze taglianti con espulsore, smontabile

Maulbreite Jaw width Anchura de la boca Largeur de mors Larghezza della bocca	40° aufwärts schneidend cutting upward corte arriba tranchant vers le haut tagliante verso l'alto				90° aufwärts schneidend cutting upward corte arriba tranchant vers le haut tagliante verso l'alto				
	L	18 cm	20 cm	23 cm	28 cm	18 cm	20 cm	23 cm	28 cm
1 mm	St	B14-159-01	B14-159-03	B14-159-05	B14-159-07	B14-159-02	B14-159-04	B14-159-06	B14-159-08
	SB	B14-160-01	B14-160-03	B14-160-05	B14-160-07	B14-160-02	B14-160-04	B14-160-06	B14-160-08
2 mm	St	B14-159-09	B14-159-11	B14-159-13	B14-159-15	B14-159-10	B14-159-12	B14-159-14	B14-159-16
	SB	B14-160-09	B14-160-11	B14-160-13	B14-160-15	B14-160-10	B14-160-12	B14-160-14	B14-160-16
3 mm	St	B14-159-17	B14-159-19	B14-159-21	B14-159-23	B14-159-18	B14-159-20	B14-159-22	B14-159-24
	SB	B14-160-17	B14-160-19	B14-160-21	B14-160-23	B14-160-18	B14-160-20	B14-160-22	B14-160-24
4 mm	St	B14-159-25	B14-159-27	B14-159-29	B14-159-31	B14-159-26	B14-159-28	B14-159-30	B14-159-32
	SB	B14-160-25	B14-160-27	B14-160-29	B14-160-31	B14-160-26	B14-160-28	B14-160-30	B14-160-32
5 mm	St	B14-159-33	B14-159-35	B14-159-37	B14-159-39	B14-159-34	B14-159-36	B14-159-38	B14-159-40
	SB	B14-160-33	B14-160-35	B14-160-37	B14-160-39	B14-160-34	B14-160-36	B14-160-38	B14-160-40
6 mm	St	B14-159-41	B14-159-43	B14-159-45	B14-159-47	B14-159-42	B14-159-44	B14-159-46	B14-159-48
	SB	B14-160-41	B14-160-43	B14-160-45	B14-160-47	B14-160-42	B14-160-44	B14-160-46	B14-160-48

Laminectomy Punches

Laminektomiestanzen
Pinzas cortantes para laminectomía
Pinces emporte-pièces à laminectomie
Pinze taglienti per laminectomia

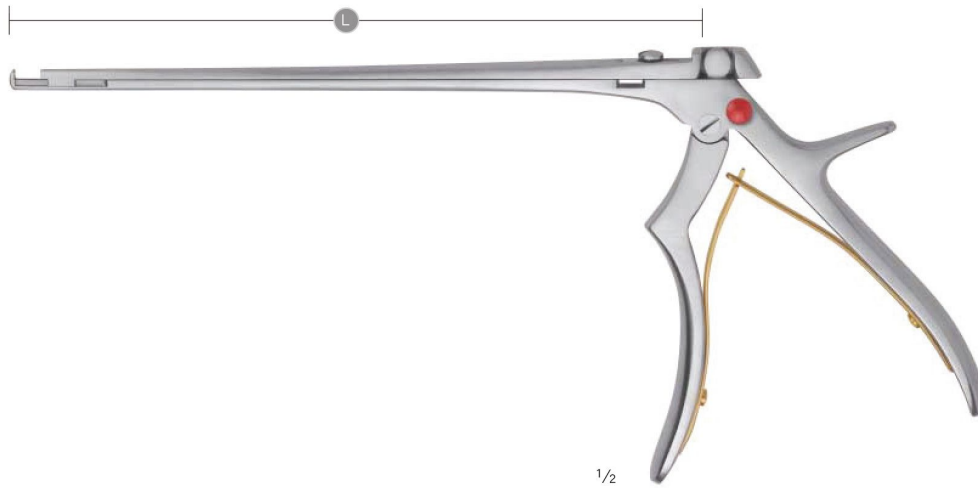

Ferris-Smith-Kerrison

B14-161-01

B14-162-48

Stanze mit Auswerfer, zerlegbar dünne Platte
Punch, with ejector, detachable, thin plate
Perforador con eyector, desmontable, placa delgada
Perforateur avec éjecteur, démontable plaque mince
Pinze taglienti con espulsore, smontabile piastra sottile

Maulbreite Jaw width Anchura de la boca Largeur de mors Larghezza della bocca	40° aufwärts schneidend cutting upward corte arriba tranchant vers le haut tagliante verso l'alto				90° aufwärts schneidend cutting upward corte arriba tranchant vers le haut tagliante verso l'alto				
	L	18 cm	20 cm	23 cm	28 cm	18 cm	20 cm	23 cm	28 cm
1 mm	SK	B14-161-01	B14-161-03	B14-161-05	B14-161-07	B14-161-02	B14-161-04	B14-161-06	B14-161-08
	SB	B14-162-01	B14-162-03	B14-162-05	B14-162-07	B14-162-02	B14-162-04	B14-162-06	B14-162-08
2 mm	SK	B14-161-09	B14-161-11	B14-161-13	B14-161-15	B14-161-10	B14-161-12	B14-161-14	B14-161-16
	SB	B14-162-09	B14-162-11	B14-162-13	B14-162-15	B14-162-10	B14-162-12	B14-162-14	B14-162-16
3 mm	SK	B14-161-17	B14-161-19	B14-161-21	B14-161-23	B14-161-18	B14-161-20	B14-161-22	B14-161-24
	SB	B14-162-17	B14-162-19	B14-162-21	B14-162-23	B14-162-18	B14-162-20	B14-162-22	B14-162-24
4 mm	SK	B14-161-25	B14-161-27	B14-161-29	B14-161-31	B14-161-26	B14-161-28	B14-161-30	B14-161-32
	SB	B14-162-25	B14-162-27	B14-162-29	B14-162-31	B14-162-26	B14-162-28	B14-162-30	B14-162-32
5 mm	SK	B14-161-33	B14-161-35	B14-161-37	B14-161-39	B14-161-34	B14-161-36	B14-161-38	B14-161-40
	SB	B14-162-33	B14-162-35	B14-162-37	B14-162-39	B14-162-34	B14-162-36	B14-162-38	B14-162-40
6 mm	SK	B14-161-41	B14-161-43	B14-161-45	B14-161-47	B14-161-42	B14-161-44	B14-161-46	B14-161-48
	SB	B14-162-41	B14-162-43	B14-162-45	B14-162-47	B14-162-42	B14-162-44	B14-162-46	B14-162-48



Laminectomy Punches

Laminektomiestanzen
Pinzas cortantes para laminectomia
Pinces emporte-pièces à laminectomie
Pinze taglienti per laminectomia



Ferris-Smith-Kerrison

B14-163-90

B14-164-95

Stanze mit Auswerfer, zerlegbar, Langhub
Punch, with ejector, detachable, long stroke
Perforador con eyector, desmontable, carrera larga
Perforateur avec éjecteur, démontable, course longue
Pinze taglienti con espulsore, smontabile, corsa lunga

Maulbreite Jaw width Anchura de la boca Largeur de mors Larghezza della bocca		40° aufwärts schneidend cutting upward corte arriba tranchant vers le haut tagliante verso l'alto	
1 mm			18 cm
			B14-163-90
			B14-164-90
2 mm			B14-163-91
			B14-164-91
3 mm			B14-163-92
			B14-164-92
4 mm			B14-163-93
			B14-164-93
5 mm			B14-163-94
			B14-164-94
6 mm			B14-163-95
			B14-164-95

Laminectomy Punches

Laminektomiestanzen
Pinzas cortantes para laminectomía
Pinces emporte-pièces à laminectomie
Pinze taglienti per laminectomia









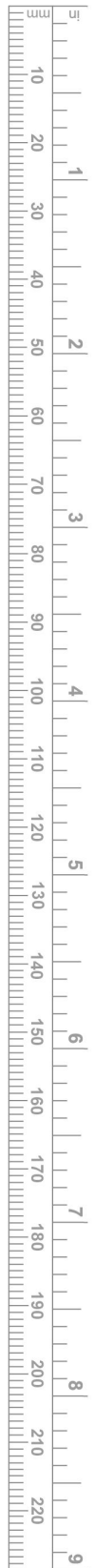

Ferris-Smith-Kerrison

B14-165-70

B14-166-75

Stanze mit Auswerfer, zerlegbar dünne Platte, Langhub,
Punch, with ejector, detachable, thin plate, long stroke
Perforador con eyector, desmontable, placa delgada, carrera larga
Perforateur avec éjecteur, démontable, plaque mince, course longue
Pinze taglienti con espulsore, smontabile, piastra sottile, corsa lunga



Maulbreite Jaw width Anchura de la boca Largeur de mors Larghezza della bocca	40° aufwärts schneidend cutting upward corte arriba tranchant vers le haut tagliante verso l'alto	
1 mm 	L 18 cm St B14-165-70 SB B14-166-70	
2 mm 	St B14-165-71 SB B14-166-71	
3 mm 	St B14-165-72 SB B14-166-72	
4 mm 	St B14-165-73 SB B14-166-73	
5 mm 	St B14-165-74 SB B14-166-74	
6 mm 	St B14-165-75 SB B14-166-75	

Laminectomy Punches

Laminektomiestanzen
Pinzas cortantes para laminectomía
Pinces emporte-pièces à laminectomie
Pinze taglienti per laminectomia



Ferris-Smith-Kerrison

B14-167-50

B14-168-85

Stanze mit Auswerfer, zerlegbar
Punch, with ejector, detachable
Perforador con eyector, desmontable
Perforateur avec éjecteur, démontable
Pinze taglienti con espulsore, smontabile

Maulbreite Jaw width Anchura de la boca Largeur de mors Larghezza della bocca	40° abwärts schneidend cutting downward desmontable, corte abajo tranchant vers le bas tagliente verso il basso			90° abwärts schneidend cutting downward desmontable, corte abajo tranchant vers le bas tagliente verso il basso			
	L	18 cm	20 cm	23 cm	18 cm	20 cm	23 cm
1 mm	St	B14-167-50	B14-167-52	B14-167-54	B14-167-51	B14-167-53	B14-167-55
	SB	B14-168-50	B14-168-52	B14-168-54	B14-168-51	B14-168-53	B14-168-55
2 mm	St	B14-167-56	B14-167-58	B14-167-60	B14-167-57	B14-167-59	B14-167-61
	SB	B14-168-56	B14-168-58	B14-168-60	B14-168-57	B14-168-59	B14-168-61
3 mm	St	B14-167-62	B14-167-64	B14-167-66	B14-167-63	B14-167-65	B14-167-67
	SB	B14-168-62	B14-168-64	B14-168-66	B14-168-63	B14-168-65	B14-168-67
4 mm	St	B14-167-68	B14-167-70	B14-167-72	B14-167-69	B14-167-71	B14-167-73
	SB	B14-168-68	B14-168-70	B14-168-72	B14-168-69	B14-168-71	B14-168-73
5 mm	St	B14-167-74	B14-167-76	B14-167-78	B14-167-75	B14-167-77	B14-167-79
	SB	B14-168-74	B14-168-76	B14-168-78	B14-168-75	B14-168-77	B14-168-79
6 mm	St	B14-167-80	B14-167-82	B14-167-84	B14-167-81	B14-167-83	B14-167-85
	SB	B14-168-80	B14-168-82	B14-168-84	B14-168-81	B14-168-83	B14-168-85



Laminectomy Punches

Laminektomiestanzen
 Pinzas cortantes para laminectomía
 Pinces emporte-pièces à laminectomie
 Pinze taglienti per laminectomia



Ferris-Smith-Kerrison

B14-169-85

B14-170-96

Stanze mit Auswerfer, zerlegbar dünne Platte
 Punch, with ejector, detachable, thin plate
 Perforador con eyector, desmontable, placa delgada
 Perforateur avec éjecteur, démontable plaque mince
 Pinze taglienti con espulsore, smontabile piastra sottile



Maulbreite Jaw width Anchura de la boca Largeur de mors Larghezza della bocca	40° abwärts schneidend cutting downward desmontable, corte abajo tranchant vers le bas tagliente verso il basso		90° abwärts schneidend cutting downward desmontable, corte abajo tranchant vers le bas tagliente verso il basso	
1 mm				
2 mm				
3 mm				
4 mm				
5 mm				
6 mm				

Laminectomy Punches

Laminektomiestanzen
Pinzas cortantes para laminectomia
Pinces emporte-pièces à laminectomie
Pinze taglienti per laminectomia

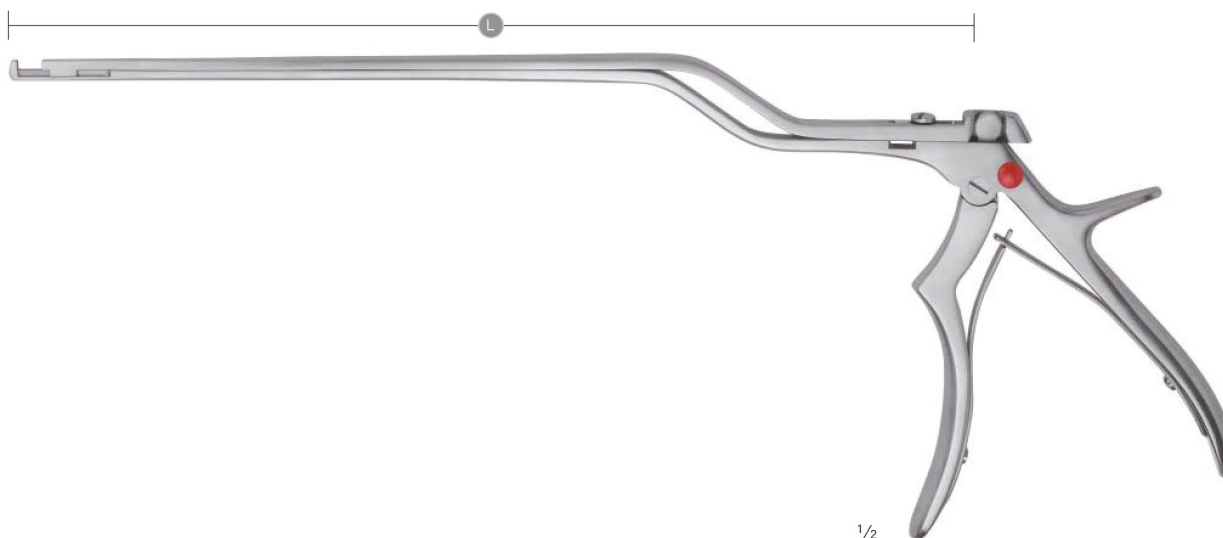

Ferris-Smith-Kerrison

B14-171-01

B14-172-20

Stanze mit Auswerfer, zerlegbar
Punch, with ejector, detachable
Perforador con eyector, desmontable
Perforateur avec éjecteur, démontable
Pinze taglienti con espulsore, smontabile

Maulbreite Jaw width Anchura de la boca Largeur de mors Larghezza della bocca	40° aufwärts schneidend, bayonett cutting upward, bayonet corte arriba, bayoneta tranchant vers le haut, baïonnette tagliente verso l'alto, baionetta		90° aufwärts schneidend, bayonett cutting upward, bayonet corte arriba, bayoneta tranchant vers le haut, baïonnette tagliente verso l'alto, baionetta		
	L	15 cm	18 cm	15 cm	18 cm
1 mm	St	B14-171-01	B14-171-03	B14-171-02	B14-171-04
	SB	B14-172-01	B14-172-03	B14-172-02	B14-172-04
2 mm	St	B14-171-05	B14-171-07	B14-171-06	B14-171-08
	SB	B14-172-05	B14-172-07	B14-172-06	B14-172-08
3 mm	St	B14-171-09	B14-171-11	B14-171-10	B14-171-12
	SB	B14-172-09	B14-172-11	B14-172-10	B14-172-12
4 mm	St	B14-171-13	B14-171-15	B14-171-14	B14-171-16
	SB	B14-172-13	B14-172-15	B14-172-14	B14-172-16
5 mm	St	B14-171-17	B14-171-19	B14-171-18	B14-171-20
	SB	B14-172-17	B14-172-19	B14-172-18	B14-172-20



Laminectomy Punches

Laminektomiestanzen
Pinzas cortantes para laminectomia
Pincas emporte-pièces à laminectomie
Pinze taglienti per laminectomia

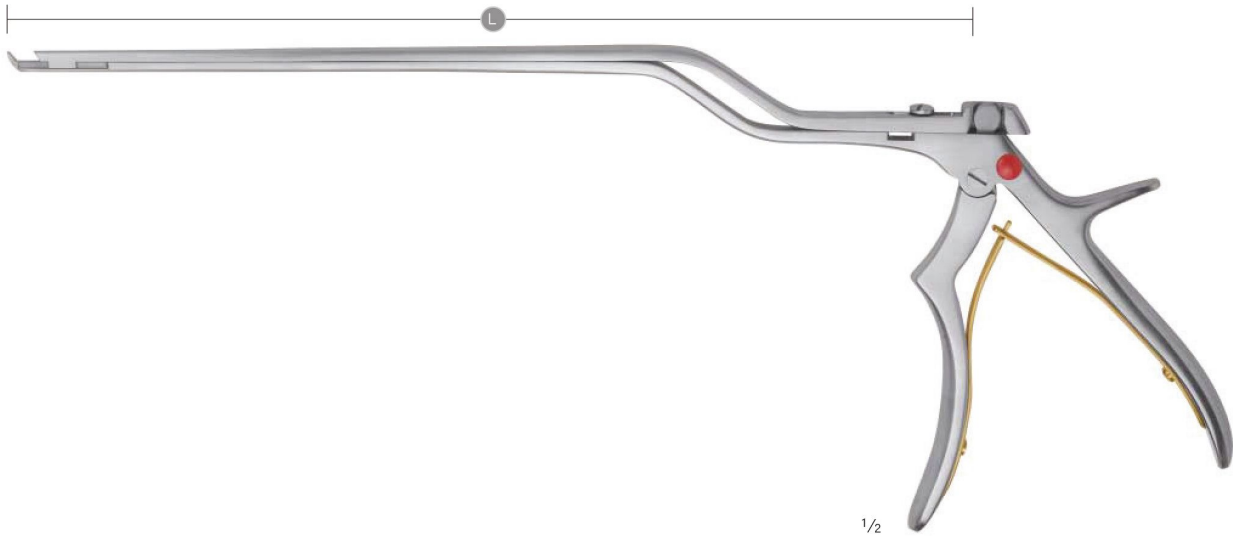

Ferris-Smith-Kerrison

B14-173-50

B14-174-69

Stanze mit Auswerfer, zerlegbar/dünne Platte
Punch, with ejector, detachable, thin plate
Perforador con eyector, desmontable, placa delgada
Perforateur avec éjecteur, démontable plaque mince
Pinze taglienti con espulsore, smontabile/pietra sottile

Maulbreite Jaw width Anchura de la boca Largeur de mors Larghezza della bocca	40° aufwärts schneidend, bajonett cutting upward, bayonet corte arriba, bayoneta tranchant vers le haut, baïonnette tagliante verso l'alto, baionetta				90° aufwärts schneidend, bajonett cutting upward, bayonet corte arriba, bayoneta tranchant vers le haut, baïonnette tagliante verso l'alto, baionetta					
	L	15 cm	18 cm	15 cm	18 cm	15 cm	18 cm	15 cm	18 cm	
1 mm	St	B14-173-50	B14-173-52	B14-173-51	B14-173-53	SB	B14-174-50	B14-174-52	B14-174-51	B14-174-53
	SB	B14-174-50	B14-174-52	B14-174-51	B14-174-53					
2 mm	St	B14-173-54	B14-173-56	B14-173-55	B14-173-57	SB	B14-174-54	B14-174-56	B14-174-55	B14-174-57
	SB	B14-174-54	B14-174-56	B14-174-55	B14-174-57					
3 mm	St	B14-173-58	B14-173-60	B14-173-59	B14-173-61	SB	B14-174-58	B14-174-60	B14-174-59	B14-174-61
	SB	B14-174-58	B14-174-60	B14-174-59	B14-174-61					
4 mm	St	B14-173-62	B14-173-64	B14-173-63	B14-173-65	SB	B14-174-62	B14-174-64	B14-174-63	B14-174-65
	SB	B14-174-62	B14-174-64	B14-174-63	B14-174-65					
5 mm	St	B14-173-66	B14-173-68	B14-173-67	B14-173-69	SB	B14-174-66	B14-174-68	B14-174-67	B14-174-69
	SB	B14-174-66	B14-174-68	B14-174-67	B14-174-69					

Laminectomy Punches

Laminektomiestanzen
Pinzas cortantes para laminectomia
Pinces emporte-pièces à laminectomie
Pinze taglienti per laminectomia

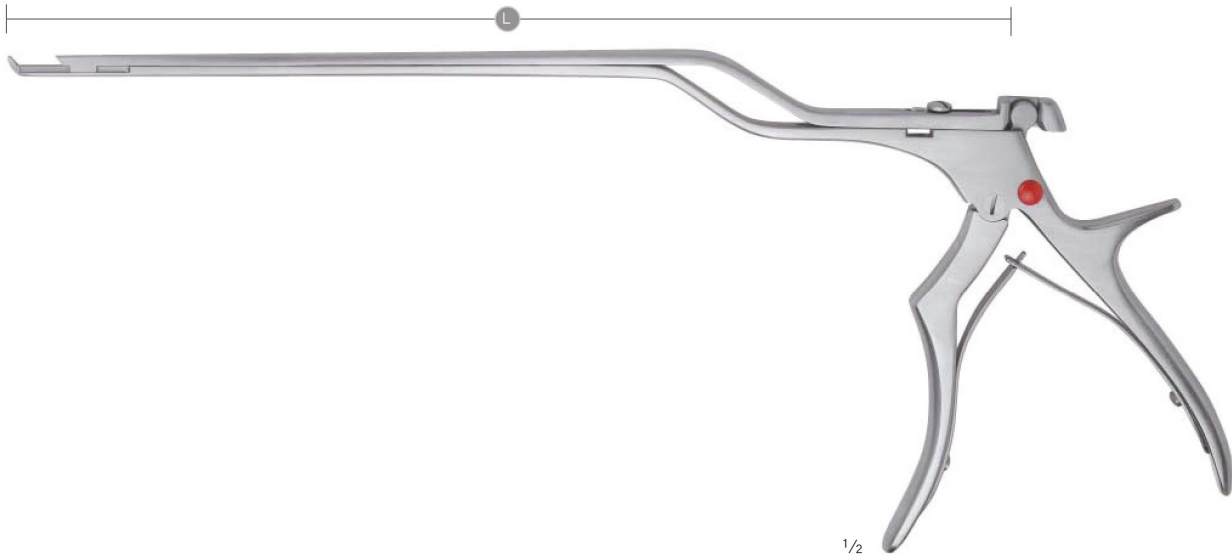

Ferris-Smith-Kerrison

B14-175-21

B14-176-25

Stanze mit Auswerfer, zerlegbar, Langhub
Punch, with ejector, detachable, long stroke
Perforador con eyector, desmontable, carrera larga
Perforateur avec éjecteur, démontable, course longue
Pinze taglienti con espulsore, smontabile, corsa lunga

Maulbreite Jaw width Anchura de la boca Largeur de mors Larghezza della bocca	40° aufwärts schneidend, bajonett cutting upward, bayonet corte arriba, bayoneta tranchant vers le haut, baïonnette tagliente verso l'alto, baionetta
	L 18 cm
1 mm	St B14-175-21 SB B14-176-21
2 mm	St B14-175-22 SB B14-176-22
3 mm	St B14-175-23 SB B14-176-23
4 mm	St B14-175-24 SB B14-176-24
5 mm	St B14-175-25 SB B14-176-25



Laminectomy Punches

Laminektomiestanzen
Pinzas cortantes para laminectomia
Pinces emporte-pièces à laminectomie
Pinze taglienti per laminectomia



14

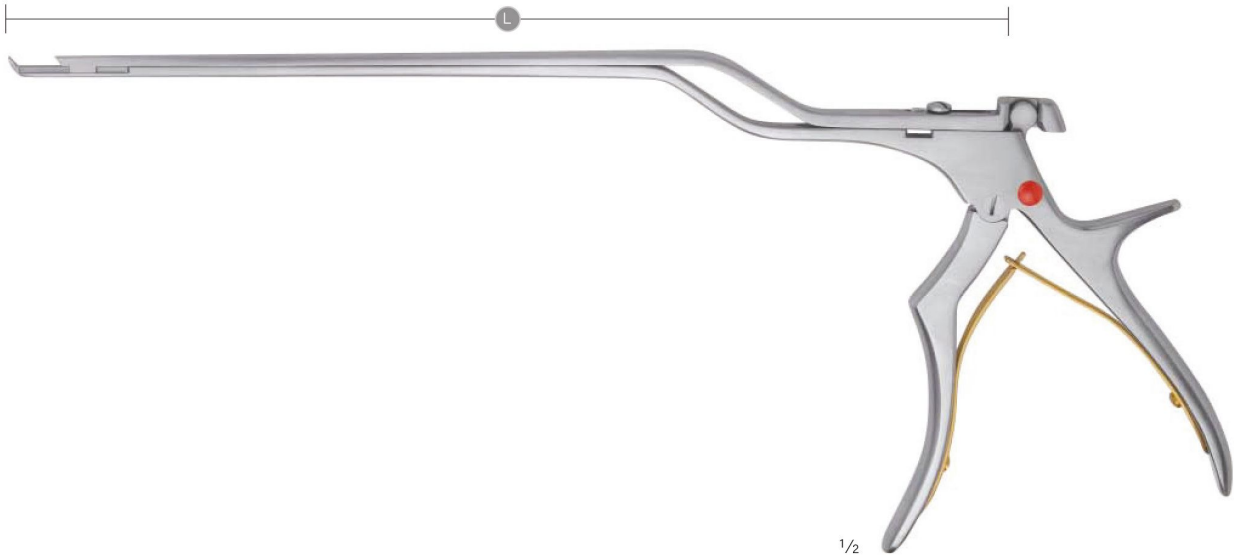

Ferris-Smith-Kerrison

B14-177-80

B14-178-84

Stanze mit Auswerfer, zerlegbar, Langhub, dünne Platte
Punch, with ejector, detachable, long stroke, thin plate
Perforador con eyector, desmontable, carrera larga, placa delgada
Perforateur avec éjecteur, démontable, course longue, plaque mince
Pinze taglienti con espulsore, smontabile, corsa lunga, piastra sottile

Maulbreite Jaw width Anchura de la boca Largeur de mors Larghezza della bocca	40° aufwärts schneidend, bajonett cutting upward, bayonet corte arriba, bayoneta tranchant vers le haut, baïonnette tagliante verso l'alto, baionetta						
1 mm	<table border="1"> <tr> <td>L</td> <td>18 cm</td> </tr> <tr> <td>St</td> <td>B14-177-80</td> </tr> <tr> <td>SB</td> <td>B14-178-80</td> </tr> </table>	L	18 cm	St	B14-177-80	SB	B14-178-80
L	18 cm						
St	B14-177-80						
SB	B14-178-80						
2 mm	<table border="1"> <tr> <td>St</td> <td>B14-177-81</td> </tr> <tr> <td>SB</td> <td>B14-178-81</td> </tr> </table>	St	B14-177-81	SB	B14-178-81		
St	B14-177-81						
SB	B14-178-81						
3 mm	<table border="1"> <tr> <td>St</td> <td>B14-177-82</td> </tr> <tr> <td>SB</td> <td>B14-178-82</td> </tr> </table>	St	B14-177-82	SB	B14-178-82		
St	B14-177-82						
SB	B14-178-82						
4 mm	<table border="1"> <tr> <td>St</td> <td>B14-177-83</td> </tr> <tr> <td>SB</td> <td>B14-178-83</td> </tr> </table>	St	B14-177-83	SB	B14-178-83		
St	B14-177-83						
SB	B14-178-83						
5 mm	<table border="1"> <tr> <td>St</td> <td>B14-177-84</td> </tr> <tr> <td>SB</td> <td>B14-178-84</td> </tr> </table>	St	B14-177-84	SB	B14-178-84		
St	B14-177-84						
SB	B14-178-84						



40



Laminectomy Punches

Laminektomiestanzen
Pinzas cortantes para laminectomia
Pinces emporte-pièces à laminectomie
Pinze taglienti per laminectomia

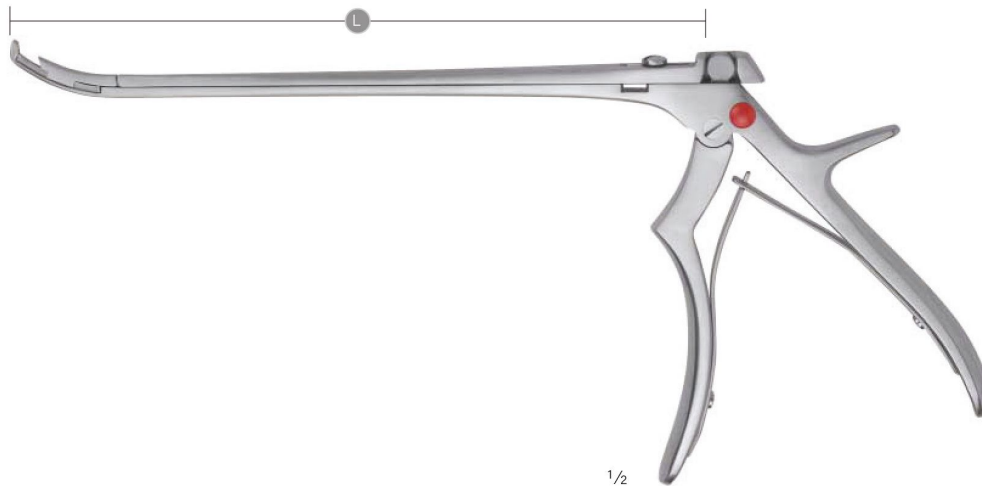

Ferris-Smith-Kerrison

B14-179-30

B14-180-44

Stanze mit Auswerfer, zerlegbar
Punch, with ejector, detachable
Perforador con eyector, desmontable
Perforateur avec éjecteur, démontable
Pinze taglienti con espulsore, smontabile

Maulbreite Jaw width Anchura de la boca Largeur de mors Larghezza della bocca	40° aufwärts gebogen curved upward curvo arriba coudé vers le haut curva verso l'alto		40° links gebogen curved leftwards curvo izquierda coudé à gauche curva a sinistra		40° rechts gebogen curved rightwards curvo derecha coudé à droite curva a destra	
1 mm	20 cm	B14-179-30	B14-179-31	B14-179-30	B14-180-31	B14-179-32
		B14-180-30	B14-180-34	B14-180-32		
2 mm	B14-179-33	B14-179-34	B14-179-35	B14-180-33	B14-180-34	B14-180-35
3 mm	B14-179-36	B14-179-37	B14-179-38	B14-180-36	B14-180-37	B14-180-38
4 mm	B14-179-39	B14-179-40	B14-179-41	B14-180-39	B14-180-40	B14-180-41
5 mm	B14-179-42	B14-179-43	B14-179-44	B14-180-42	B14-180-43	B14-180-44



Laminectomy Punches

Laminektomiestanzen
Pinzas cortantes para laminectomía
Pinces emporte-pièces à laminectomie
Pinze taglienti per laminectomia



14

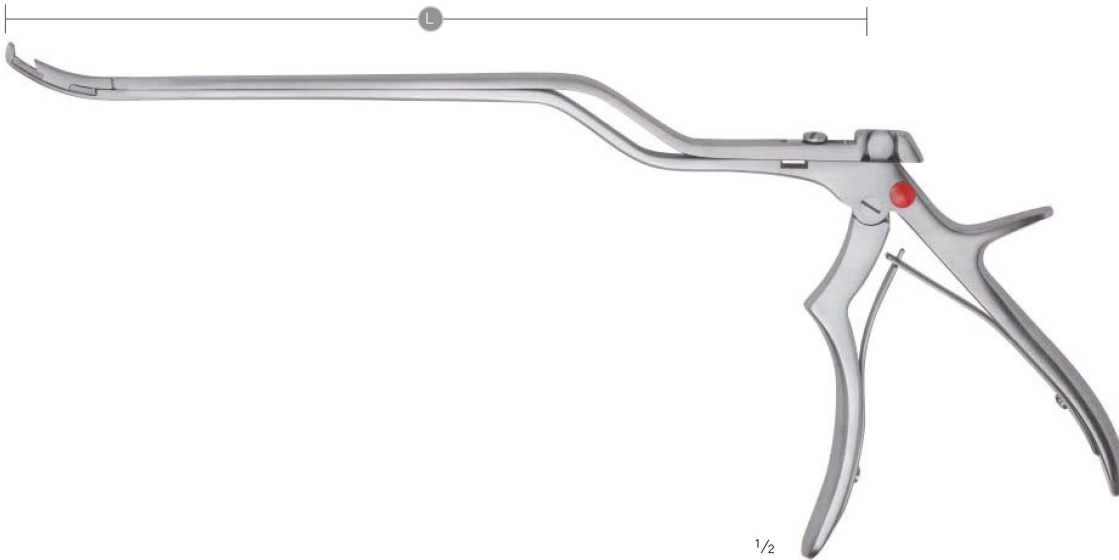

Ferris-Smith-Kerrison B14-181-50

Stanze mit Auswerfer, zerlegbar
Punch, with ejector, detachable
Perforador con eyector, desmontable
Perforateur avec éjecteur, démontable
Pinze taglienti con espulsore, smontabile

Maulbreite Jaw width Anchura de la boca Largeur de mors Larghezza della bocca	40° gebogen, bajonett curved, bayonet curvo, bayoneta coudé, baïonnette curva, baionetta	
3 mm	L 18 cm	
	st B14-181-50	



42

Rongeurs

Rongeur
Pinzas cortantes
Rongeurs
Pinze per afferrare

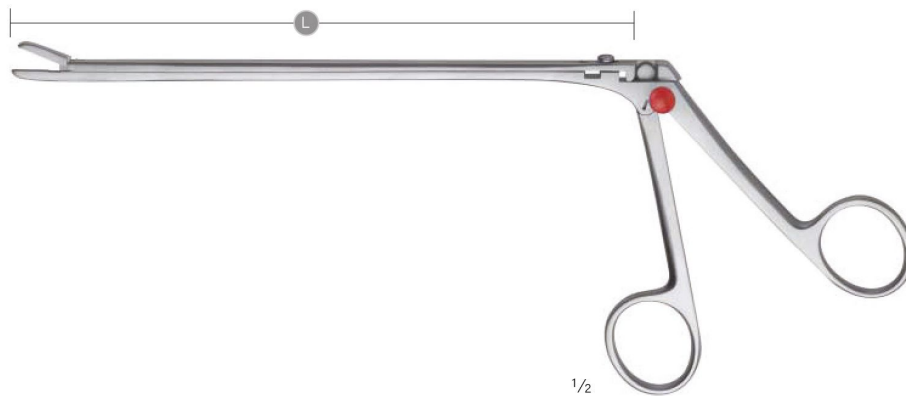





Caspar

B14-182-05

B14-183-20

zerlegbar
detachable
desmontable
démontable
smontabile

Maulbreite Jaw width Anchura de la boca Largeur de mors Larghezza della bocca	gerade straight recto droit diritto				
	L	15 cm	18 cm	20 cm	30 cm
2 mm 	St	B14-182-05	B14-182-09	B14-182-13	B14-182-14
	SB	B14-183-05	B14-183-09	B14-183-13	B14-183-14
3 mm 	St	B14-182-06	B14-182-10	B14-182-14	B14-182-18
	SB	B14-183-06	B14-183-10	B14-183-14	B14-183-18
4 mm 	St	B14-182-07	B14-182-11	B14-182-15	B14-182-19
	SB	B14-183-07	B14-183-11	B14-183-15	B14-183-19
5 mm 	St	B14-182-08	B14-182-12	B14-182-16	B14-182-20
	SB	B14-183-08	B14-183-12	B14-183-16	B14-183-20

Rongeurs

Rongeur
Pinzas cortantes
Rongeurs
Pinze per afferrare



Caspar

B14-184-25

B14-185-40

zerlegbar
detachable
desmontable
démontable
smontabile



Maulbreite Jaw width Anchura de la boca Largeur de mors Larghezza della bocca	2 mm	30° aufgewinkelt angled upward acodado arrib angulé vers le haut angolato verso l'alto				
		L	15 cm	18 cm	20 cm	
3 mm	St	B14-184-25	B14-184-29	B14-184-33	B14-184-37	
	SB	B14-185-25	B14-185-29	B14-185-33	B14-185-37	
4 mm	St	B14-184-26	B14-184-30	B14-184-34	B14-184-38	
	SB	B14-185-26	B14-185-30	B14-185-34	B14-185-38	
5 mm	St	B14-184-27	B14-184-31	B14-184-35	B14-184-39	
	SB	B14-185-27	B14-185-31	B14-185-35	B14-185-39	
	St	B14-184-28	B14-184-32	B14-184-36	B14-184-40	
	SB	B14-185-28	B14-185-32	B14-185-36	B14-185-40	

Rongeurs

Rongeur
Pinzas cortantes
Rongeurs
Pinze per afferrare

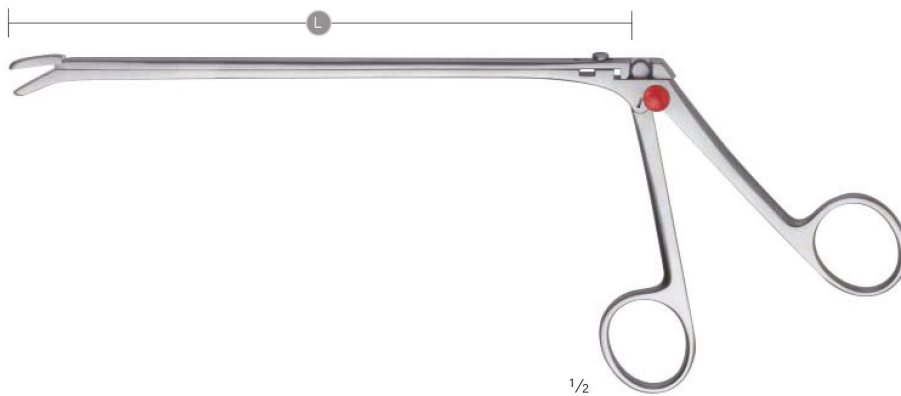





Caspar

B14-186-45

B14-187-60

zerlegbar
detachable
desmontable
démontable
smontabile

Maulbreite Jaw width Anchura de la boca Largeur de mors Larghezza della bocca	2 mm 	30° abgewinkelt angled downward acodado abajo angulé vers le bas angolato verso il basso  1/1			
		L	15 cm	18 cm	20 cm
3 mm 	St	B14-186-46	B14-186-50	B14-186-54	B14-186-58
	SB	B14-187-46	B14-187-50	B14-187-54	B14-187-58
4 mm 	St	B14-186-47	B14-186-51	B14-186-55	B14-186-59
	SB	B14-187-47	B14-187-51	B14-187-55	B14-187-59
5 mm 	St	B14-186-48	B14-186-52	B14-186-56	B14-186-60
	SB	B14-187-48	B14-187-52	B14-187-56	B14-187-60

Rongeurs

Rongeur
Pinzas cortantes
Rongeurs
Pinze per afferrare

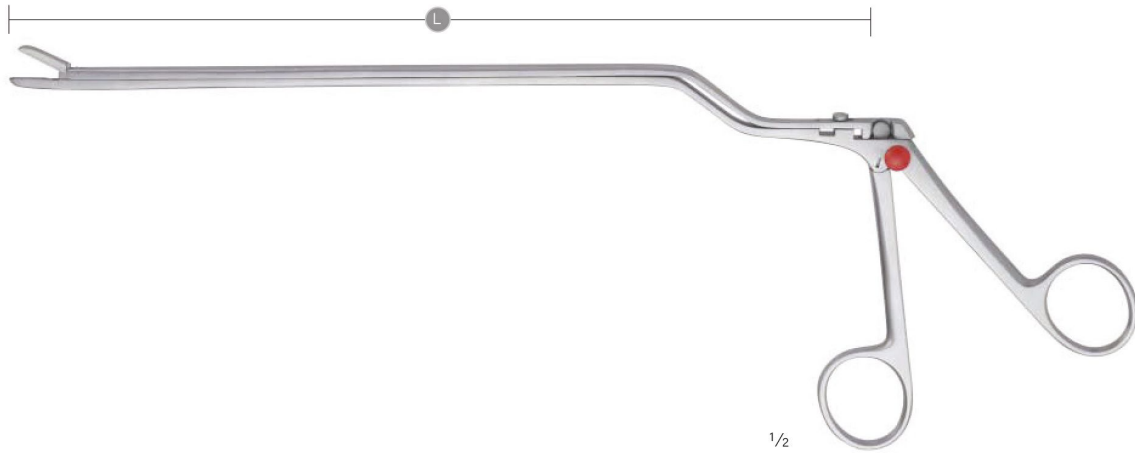





Caspar

B14-188-61

B14-189-68

zerlegbar
detachable
desmontable
démontable
smontabile



Maulbreite Jaw width Anchura de la boca Largeur de mors Larghezza della bocca	gerade, bajonett straight, bayonet recto, bayoneta droit, baïonnette diritto, baionetta	
	L	15 cm 18 cm
2 mm 	St	B14-188-61 B14-188-65
	SB	B14-189-61 B14-189-65
3 mm 	St	B14-188-62 B14-188-66
	SB	B14-189-62 B14-189-66
4 mm 	St	B14-188-63 B14-188-67
	SB	B14-189-63 B14-189-67
5 mm 	St	B14-188-64 B14-188-68
	SB	B14-189-64 B14-189-68



Rongeurs

Rongeur
Pinzas cortantes
Rongeurs
Pinze per afferrare

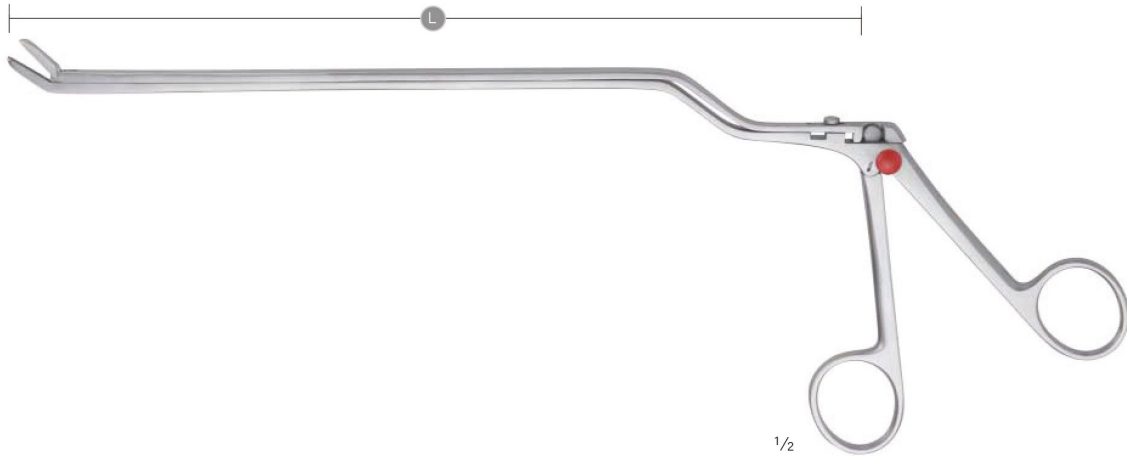

Caspar

B14-190-71

B14-191-78

zerlegbar
detachable
desmontable
démontable
smontabile

Maulbreite Jaw width Anchura de la boca Largeur de mors Larghezza della bocca	<p>30° aufgewinkelt, bajonett angled upward, bayonet acodado arriba, bayoneta angulé vers le haut, baïonnette angolato verso l'alto, baionetta</p>	L	15 cm	18 cm
		st	B14-190-71	B14-190-75
2 mm		SB	B14-191-71	B14-191-75
3 mm		st	B14-190-72	B14-190-76
		SB	B14-191-72	B14-191-76
4 mm		st	B14-190-73	B14-190-77
		SB	B14-191-73	B14-191-77
5 mm		st	B14-190-74	B14-190-78
		SB	B14-191-74	B14-191-78

Rongeurs
 Rongeur
 Pinzas cortantes
 Rongeurs
 Pinze per afferrare



14

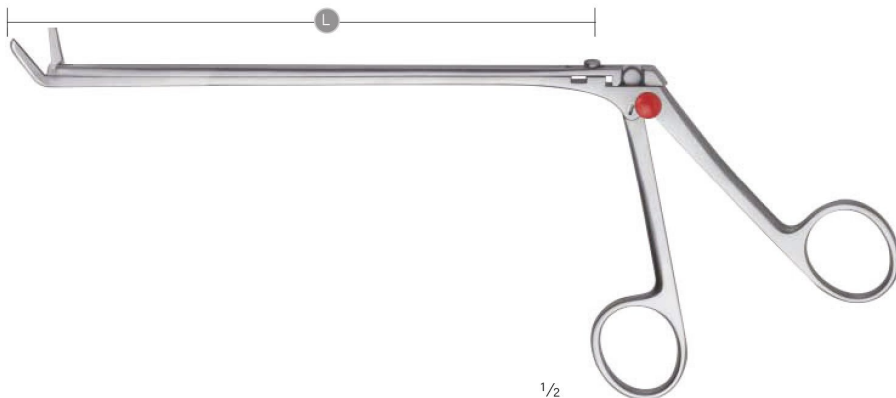

Caspar
C14-192-80
C14-193-83
 zerlegbar
 detachable
 desmontable
 démontable
 smontabile



Maulbreite Jaw width Anchura de la boca Largeur de mors Larghezza della bocca	50° aufgewinkelt angled upward acodado arrib angulé vers le haut angolato verso l'alto	50° abgewinkelt angled downward acodado abajo angulé vers le bas angolato verso il basso																														
4 mm	<table border="1"> <tr> <td>L</td> <td>18 cm</td> <td>30 cm</td> <td>18 cm</td> <td>30 cm</td> </tr> <tr> <td>st</td> <td>B14-192-80</td> <td>B14-192-81</td> <td>B14-192-82</td> <td>B14-192-83</td> </tr> <tr> <td>SB</td> <td>B14-193-80</td> <td>B14-193-81</td> <td>B14-193-82</td> <td>B14-193-83</td> </tr> </table>	L	18 cm	30 cm	18 cm	30 cm	st	B14-192-80	B14-192-81	B14-192-82	B14-192-83	SB	B14-193-80	B14-193-81	B14-193-82	B14-193-83	<table border="1"> <tr> <td>L</td> <td>18 cm</td> <td>30 cm</td> <td>18 cm</td> <td>30 cm</td> </tr> <tr> <td>st</td> <td>B14-192-80</td> <td>B14-192-81</td> <td>B14-192-82</td> <td>B14-192-83</td> </tr> <tr> <td>SB</td> <td>B14-193-80</td> <td>B14-193-81</td> <td>B14-193-82</td> <td>B14-193-83</td> </tr> </table>	L	18 cm	30 cm	18 cm	30 cm	st	B14-192-80	B14-192-81	B14-192-82	B14-192-83	SB	B14-193-80	B14-193-81	B14-193-82	B14-193-83
L	18 cm	30 cm	18 cm	30 cm																												
st	B14-192-80	B14-192-81	B14-192-82	B14-192-83																												
SB	B14-193-80	B14-193-81	B14-193-82	B14-193-83																												
L	18 cm	30 cm	18 cm	30 cm																												
st	B14-192-80	B14-192-81	B14-192-82	B14-192-83																												
SB	B14-193-80	B14-193-81	B14-193-82	B14-193-83																												

Rongeurs

Rongeur
Pinzas cortantes
Rongeurs
Pinze per afferrare

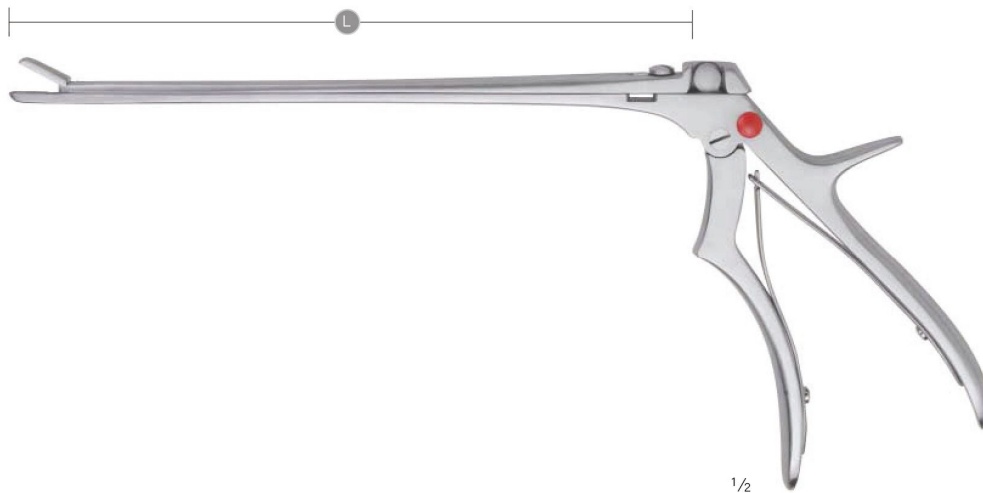

Wagner

B14-194-91

B14-195-96

zerlegbar, kräftig
detachable, strong model
desmontable, robusto
démontable, robuste
smontabile, robusto

Maulbreite Jaw width Anchura de la boca Largeur de mors Larghezza della bocca		gerade straight recto droit diritto		30° aufgewinkelt angled upward acodado arrib angulé vers le haut angolato verso l'alto		30° abgewinkelt angled downward acodado abajo angulé vers le bas angolato verso il basso	
3 mm	L	20 cm	30 cm	20 cm	30 cm	20 cm	30 cm
	st	B14-194-91	B14-194-94				
	SB	B14-195-91	B14-195-94				
4 mm	st	B14-194-92	B14-194-95	B14-194-84	B14-194-85	B14-194-86	B14-194-87
	SB	B14-195-92	B14-195-95	B14-195-84	B14-195-85	B14-195-86	B14-195-87
5 mm	st	B14-194-93	B14-194-96				
	SB	B14-195-93	B14-195-96				



Rongeurs
 Rongeur
 Pinzas cortantes
 Rongeurs
 Pinze per afferrare

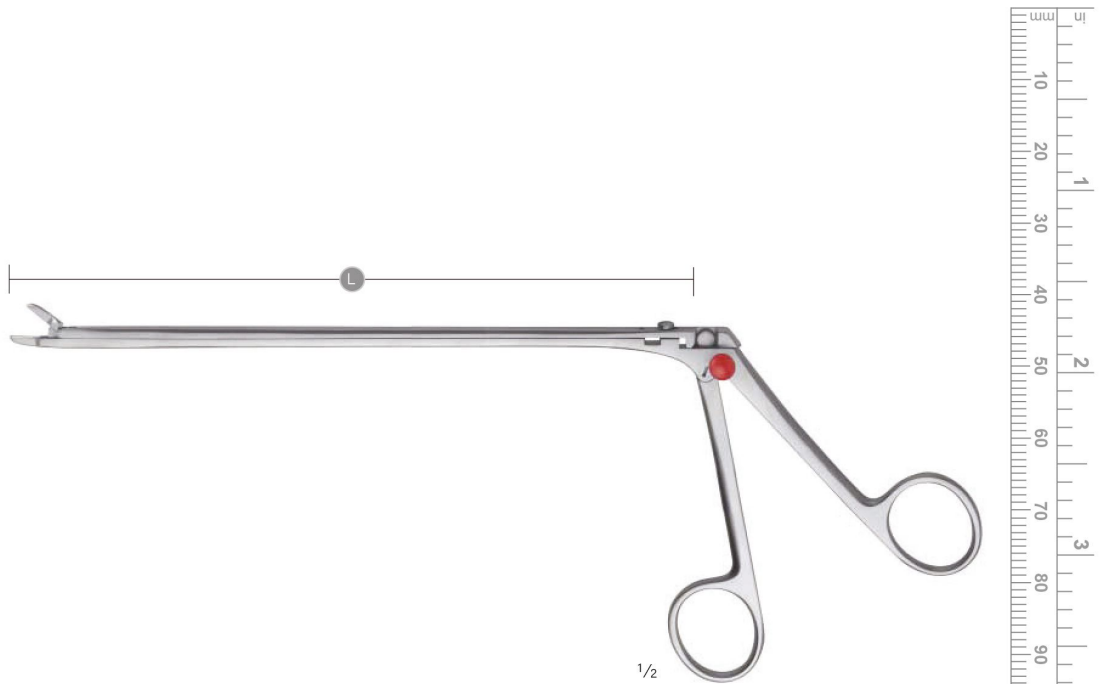

14



Richter
B14-196-10
B14-197-13
 zerlegbar
 detachable
 desmontable
 démontable
 smontabile

Maulbreite Jaw width Anchura de la boca Largeur de mors Larghezza della bocca	gerade straight recto droit diritto	30° aufgewinkelt angled upward acodado arrib angulé vers le haut angolato verso l'alto
1,0 mm	 L 18 cm St B14-196-10 SB B14-197-10	 L 18 cm St B14-196-11 SB B14-197-11
1,5 mm	St B14-196-12 SB B14-197-12	St B14-196-13 SB B14-197-13



Pituitary specula

Hypophysen-Spekula
Especulos para hipofisis
Spéculums pour hypophyse
Specoli per ipofisi

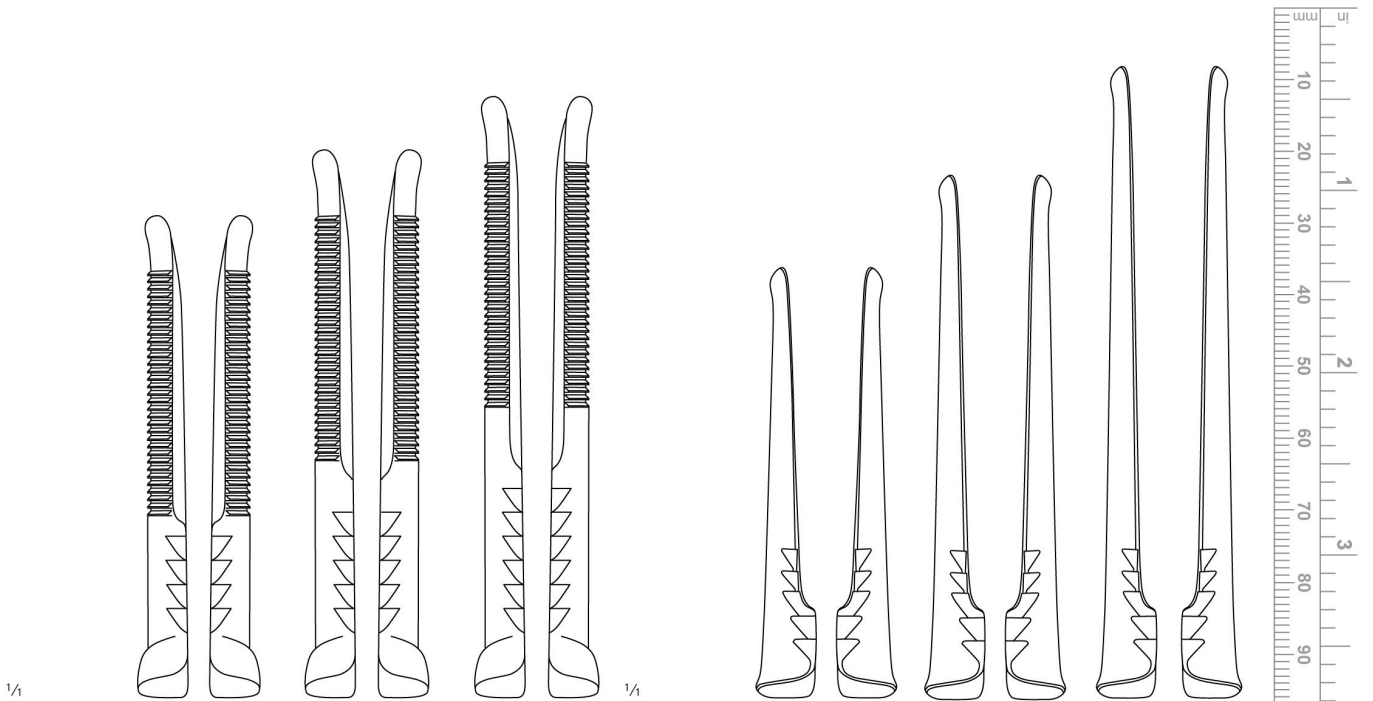

B14-201-08

80 x 13 mm



B14-201-09

90 x 13 mm



B14-201-10

100 x 13 mm



B14-202-07

70 x 15 mm



B14-202-09

90 x 15 mm



B14-202-11

110 x 15 mm



Papavero-Caspar

B14-201-08

B14-201-10

inklusive Handgriff
incl. handle
incl. mango
manche compris
compreso manico



Cushing-Landolt

B14-202-07

B14-202-11

no one does it BETTER



Cell: 0092 323 9300123

Tel: 0092 52 3563378

URL: <https://bona-dent.com>

Email: info@bona-dent.com

Email: bonadent.mfg@gmail.com

Address:

Kacha Shahab Pura Road

Jeewan Pura, Sialkot (51310)

Pakistan.

