

BRIGHTENS CURE

• FACILITATES
LIFE WALK

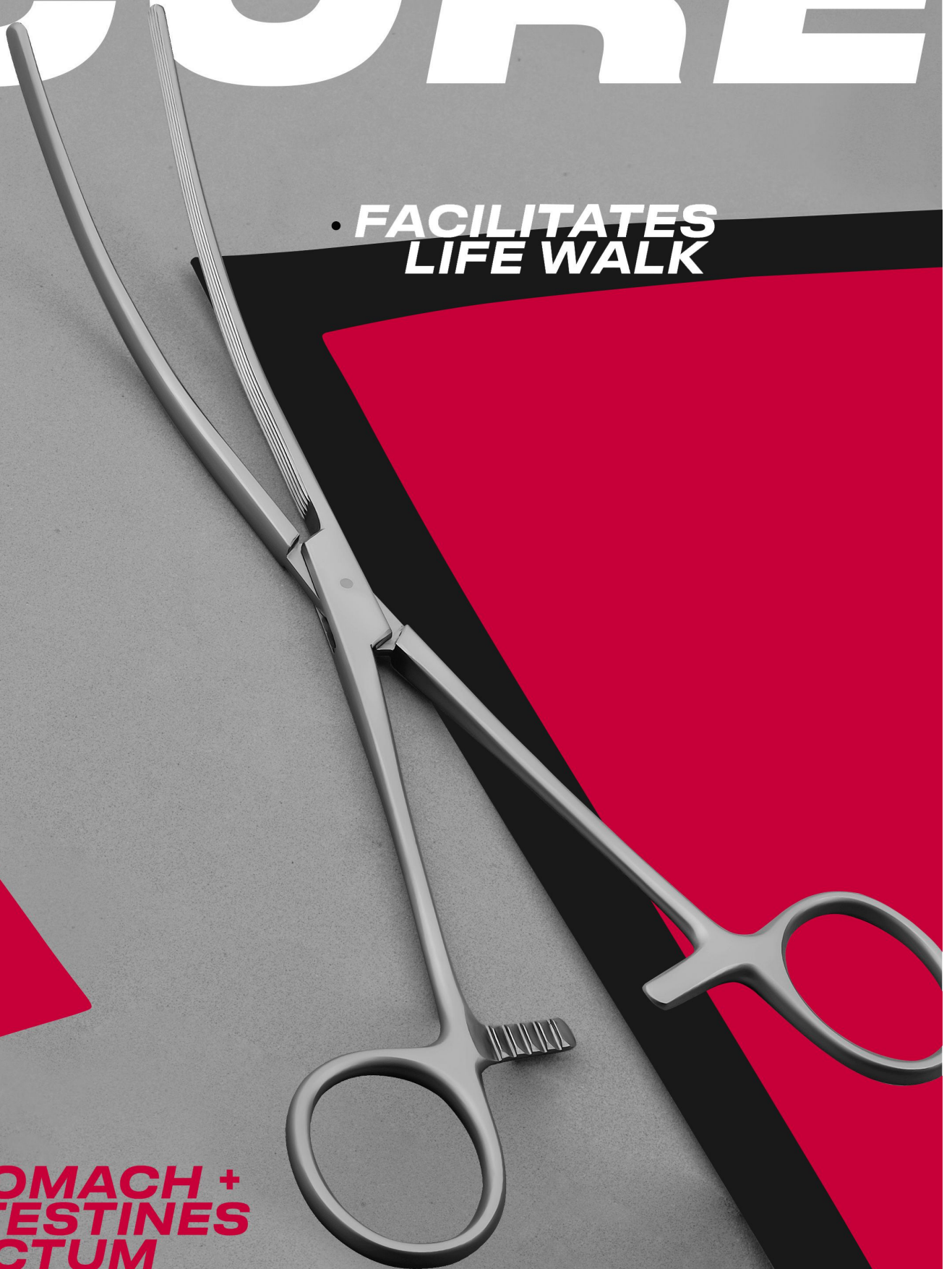

STOMACH +
INTESTINES
RECTUM



An Era Of **evolution**

Bonadent

HAS THE REPUTATION OF BEING THE ONLY IN PAKISTAN THAT MANUFACTURES ITS OWN TOOLS FOR THE PRODUCTION OF ITS INSTRUMENTS.

Bonadent is a privately owned company providing personalized services and the finest in Surgical Instruments for over 25 years. Established in 1999, Our Company manufactures a wide range of Surgical, Dental and Veterinary Instruments.

All Instruments and devices of our product range are manufactured by well-trained and experienced skilled workers with special craftsmanship and by use of most modern machines and equipment. On this occasion we only use materials which meet our high standards. The CEO of Bonadent Manufacturing co, Mr. Muhammad Ibrahim brings with him a lifetime of knowledge about the world of surgical instruments.

This insight allows us to understand the needs of our customers in a way most other instrument companies are unable to do.

After becoming a competent oem service provider, cardiac has decided to introduce itself as the original source of high quality instrumentation to directly interact with some of the well-known brands around the world.

Intestinal and Tissue Grasping Forceps

Darm- und Gewebefasszangen
 Pinzas para intestinos y tejidos
 Pinces pour saisir intestins et tissus
 Pinze per afferrare intestino e tessuti



Allis-Baby
B17-100-13
 13 cm / 5 1/8"



Allis
B17-101-15
B17-104-25

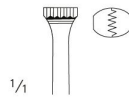

B17-101-15
 15,5 cm / 6 1/8"

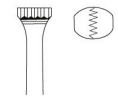

B17-102-15
 15,5 cm / 6 1/8"

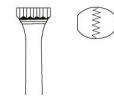

B17-103-19
 19 cm / 7 4/8"



B17-104-25
 25,5 cm / 10"



Atrauma



Allis
B17-105-15
B17-105-30

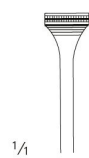

B17-105-15
 15,5 cm / 6 1/8"

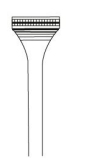

B17-105-20
 20 cm / 7 7/8"

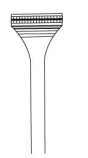

B17-105-24
 24,5 cm / 9 5/8"

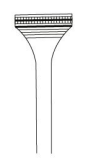

B17-105-30
 30 cm / 11 5/8"

Intestinal and Tissue Grasping Forceps

Darm- und Gewebefasszangen
 Pinzas para intestinos y tejidos
 Pinces pour saisir intestins et tissus
 Pinze per afferrare intestino e tessuti



Allis-Adair
B17-106-16
 16 cm / 6 2/8"



Boys-Allis
B17-107-15
 15,5 cm / 6"

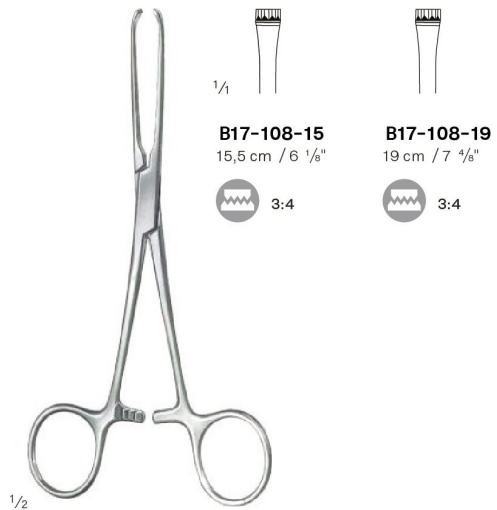

Judd-Allis
B17-108-15
B17-108-19



Thoms-Allis
B17-109-20
 20,5 cm / 8 1/8"



Allis
B17-110-20
 20 cm / 7 7/8"

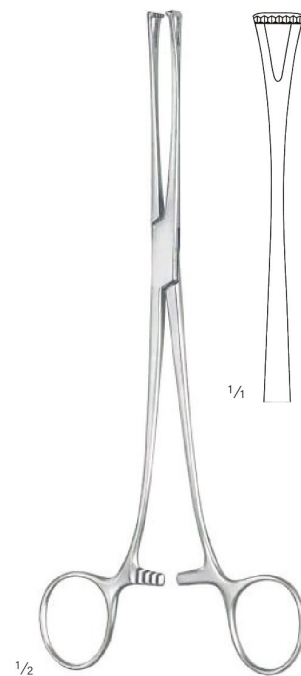

Lockwood
B17-111-20
 20 cm / 7 7/8"



Intestinal and Tissue Grasping Forceps

Darm- und Gewebefasszangen
Pinzas para intestinos y tejidos
Pincas pour saisir intestins et tissus
Pinze per afferrare intestino e tessuti

TC GOLD

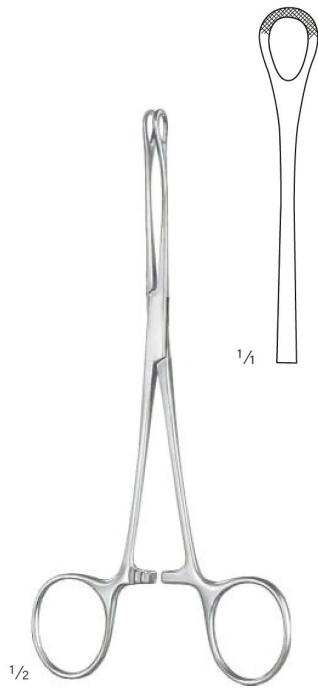

Williams
B17-112-16
16,5 cm / 6 4/8"



Babcock
B17-113-16
B17-113-20

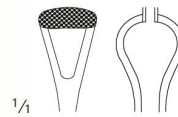

B17-113-16
16,5 cm / 6 4/8"

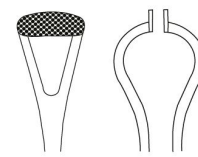

B17-113-20
21 cm / 8 2/8"

Intestinal and Tissue Grasping Forceps

Darm- und Gewebefasszangen
 Pinzas para intestinos y tejidos
 Pincas pour saisir intestins et tissus
 Pinze per afferrare intestino e tessuti

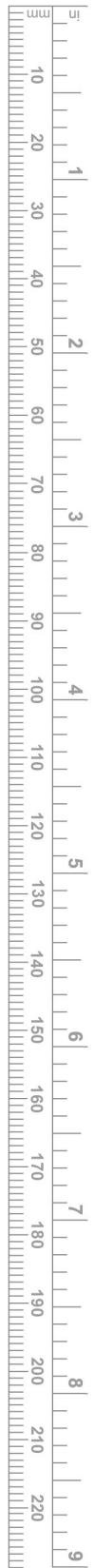

B₂

Babcock
 B17-114-15
 B17-114-24



1/4

B17-114-B15
 15,5 cm / 6"

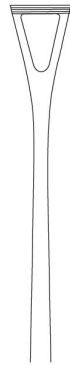

B17-114-17
 17,5 cm / 7"

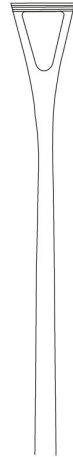

B17-114-21
 21 cm / 8 3/8"

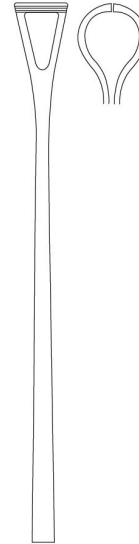

B17-114-24
 24 cm / 9 1/2"

Atrauma

TC GOLD

Atrauma



1/2

Babcock
 B17-115-16
 16 cm / 6 3/8"

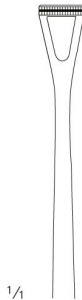

1/4

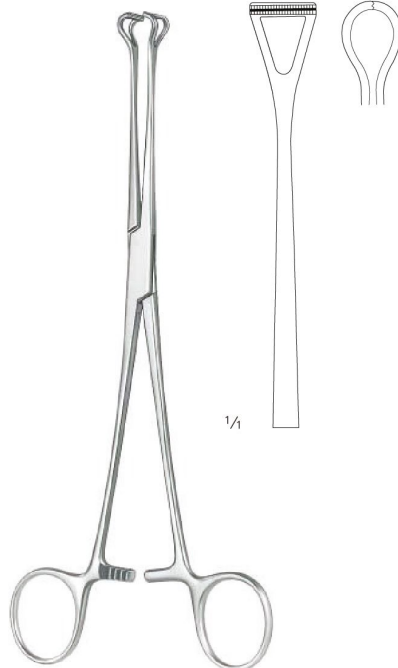

1/2

Babcock
 B17-116-21
 21 cm / 8 3/8"

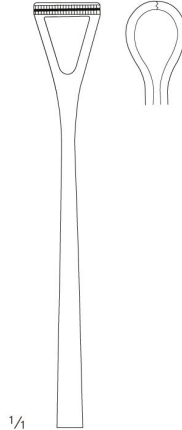

1/4

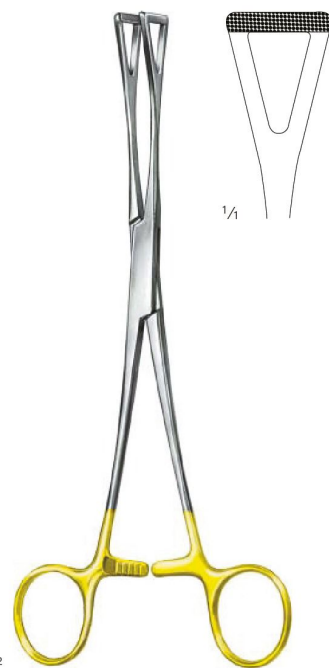

1/2

Duval
 B17-117-20
 20,5 cm / 8"

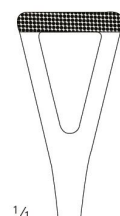

1/4

Intestinal and Tissue Grasping Forceps, Intestinal Clamps
 Darm- und Gewebefasszangen, Darmklemmen
 Pinzas para intestinos y tejidos, Pinzas intestinales
 Pincès pour saisir intestins et tissus, Pincès intestinales
 Pinze per afferrare intestino e tessuti, Pinze intestinali

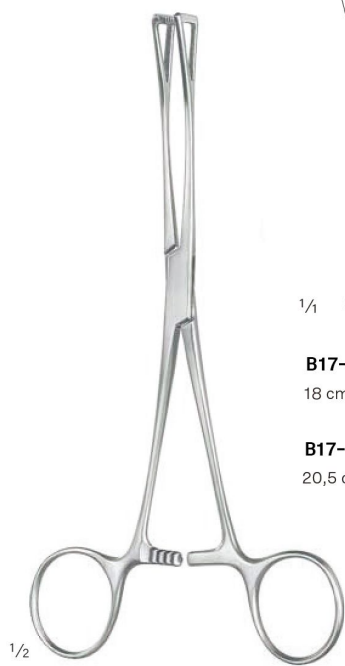

Duval
 B17-118-18
 B17-121-23

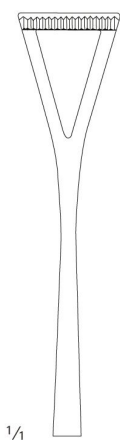

B17-118-18
 18 cm / 7 1/8"

B17-120-20
 20,5 cm / 8"

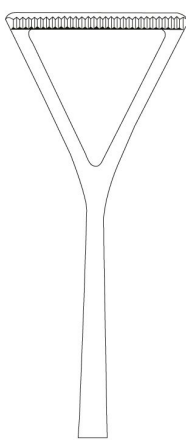

B17-119-20
 20,5 cm / 8 1/8"

B17-121-23
 23 cm / 9"



Doyen
 B17-122-22
 B17-122-23



B17-122-22
 21,5 cm / 8 4/8"

B17-122-24
 23,5 cm / 9 2/8"

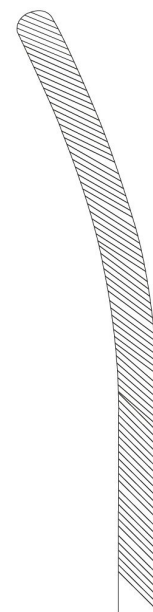

B17-122-21
 21 cm / 8 2/8"

B17-122-23
 23 cm / 9"

Intestinal Clamps
Darmklemmen
Pinzas intestinales
Pincas intestinales
Pinze intestinali



Doyen-Baby
B17-123-18
B17-123-17

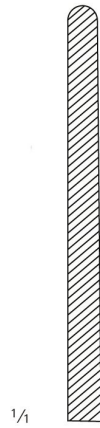

B17-123-18
18 cm / 7 1/8"

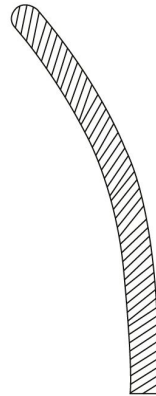

B17-123-17
17,5 cm / 6 7/8"



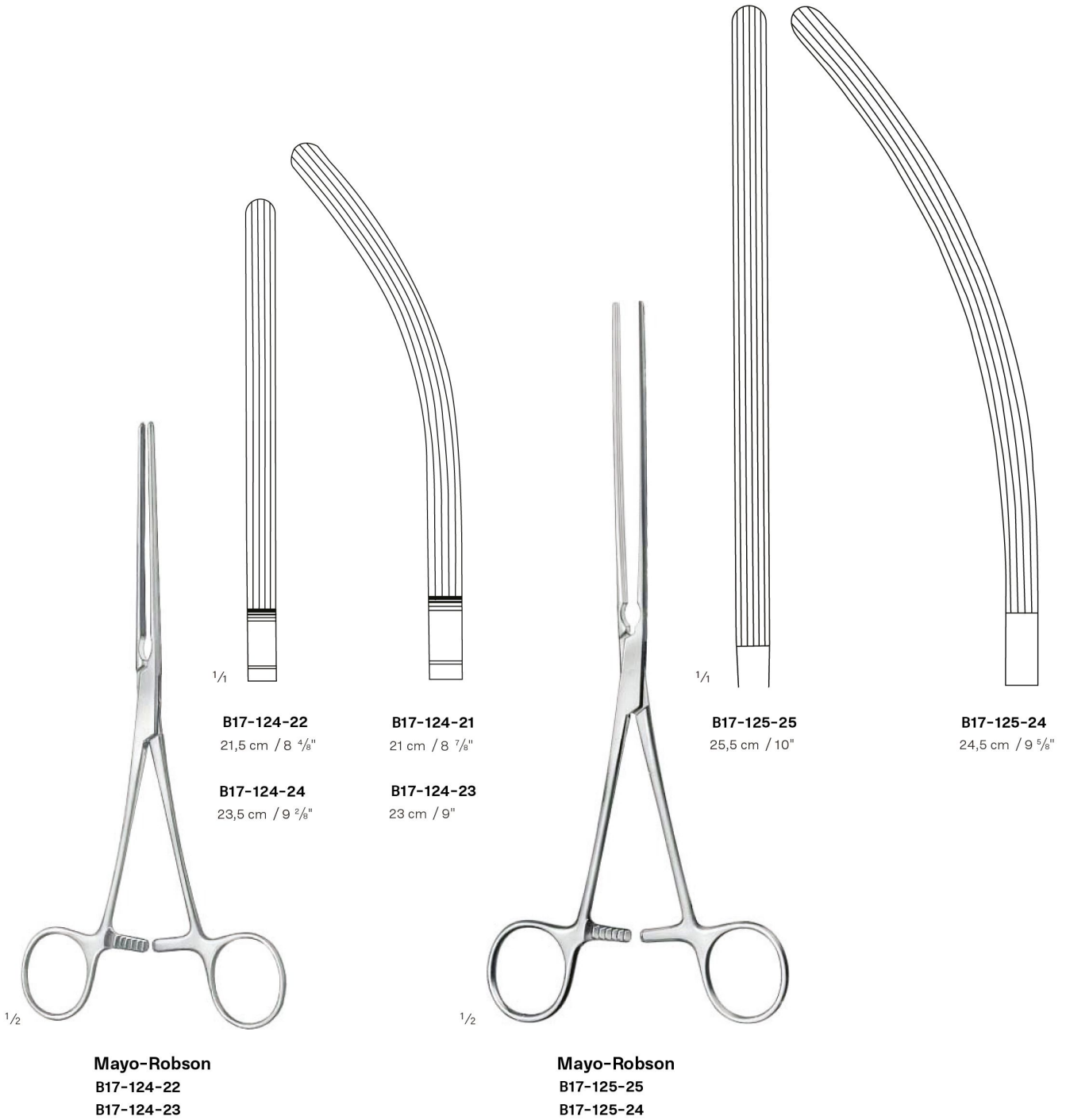

Intestinal Clamps
Darmklemmen
Pinzas intestinales
Pinces intestinales
Pinze intestinali



1/2

Kocher
B17-126-22
B17-126-28

1/4

B17-126-22
22,5 cm / 8 7/8"

B17-126-25
25 cm / 9 7/8"

B17-126-28
28 cm / 11"



Intestinal Clamps
 Darmklemmen
 Pinzas intestinales
 Pinze intestinali



1/2

Kocher
 B17-127-22
 B17-127-27

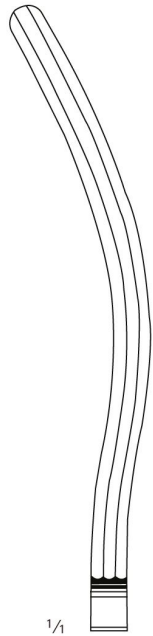

1/1

B17-127-22
 22 cm / 8 5/8"

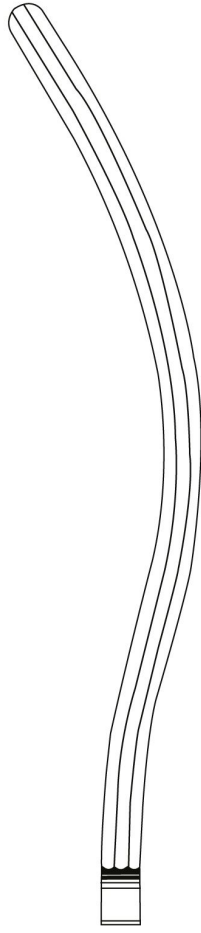

B17-127-24
 24,5 cm / 9 5/8"

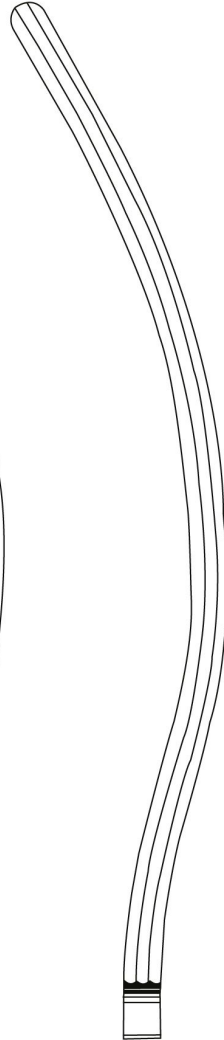

B17-127-27
 27,5 cm / 10 5/8"

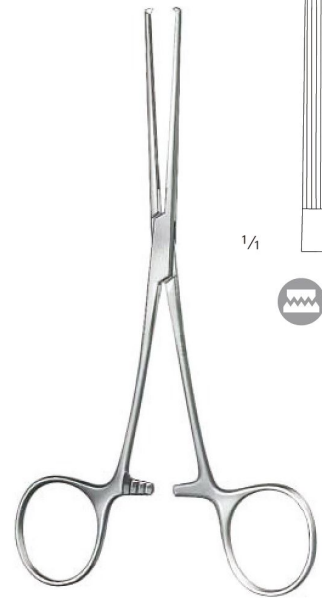

1/2

Allen
 B17-128-16
 16 cm / 6 2/8"

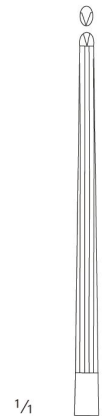

1/1



1:2

Intestinal and Pylorus Clamps
 Darmquetschklemmen
 Pinzas intestinales para piloro
 Ecraseurs pour intestin
 Schiacciatori intestinali



Payr-Baby
B17-129-15

15 cm / 5 7/8"
 mit Stift
 with pin
 con espiga
 avec cheville
 con perno

Payr
B17-130-21
B17-130-34

mit Stift
 with pin
 con espiga
 avec cheville
 con perno

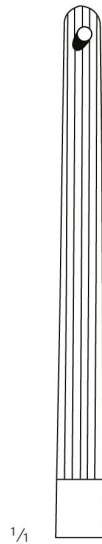

B17-130-21
 21 cm / 8 2/8"

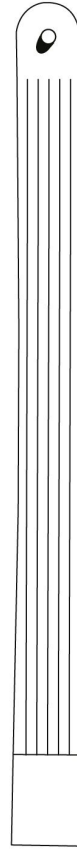

B17-130-29
 29 cm / 11 3/8"

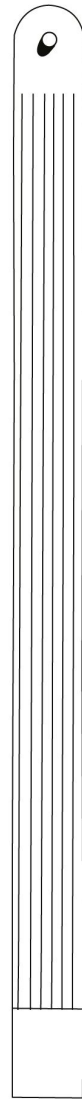

B17-130-34
 34 cm / 13 3/8"



Intestinal Anastomosis Clamps

Darm-Anastomosenklemmen
Clamps para anastomosis intestinales
Pinces pour anastomoses intestinale
Pinze per anastomosi intestinali



B17-131-05
Arbeitslänge
working length
largo útil
longueur utile
lunghezza utile
65 mm

B17-131-07
Arbeitslänge
working length
largo útil
longueur utile
lunghezza utile
80 mm

B17-131-10
Arbeitslänge
working length
largo útil
longueur utile
lunghezza utile
110 mm

De Martel-Wolfson

B17-131-05

B17-131-10

Set bestehend aus 3 Stück einer Länge:

- 2 x Riegel kurz
- 1 x Riegel lang

Set consisting of 3 pieces of one length:

- 2 x lock, short
- 1 x lock, long

Juego formado por 3 piezas de una longitud:

- 2 x pestillo corto
- 1 x pestillo largo

Set composé de 3 pièces d'une longueur:

- 2 x verrou, court
- 1 x verrou, long

Set composto da 3 pezzi di una lunghezza:

- 2 x serratura corte
- 1 x serratura lunga

De Martel-Wolfson

B17-132-27

27 cm / 10 5/8"

Klemmschließzange

Closing Forceps

Pinza para cerrar grapas

Pinces pour fermer les clamps

Serrapinze



B17-131-05
B17-131-10



Intestinal Anastomosis Clamps

Darm-Anastomosenklemmen
Clamps para anastomosis intestinales
Pinces pour anastomoses intestinale
Pinze per anastomosi intestinali



1/2

De Martel-Wolfson

B17-133-09

9,5 cm / 3 7/8"

Klemmenhalterung
Clamp Holder
Porta-clamp
Porte-clamps
Portapinze



C17-131-05
C17-131-10



1/2

De Martel-Wolfson

B17-134-23

23 cm / 9"

Klemmenhalterung
Clamp Holder
Porta-clamp
Porte-clamps
Portapinze



B17-131-05
B17-131-10



1/2

Benson

B17-135-15

15,5 cm / 6 1/8"

Pylorusspreizer
Pylorus Spreader
Separador para piloro
Ecarteur pour pylore
Divaricitaore pilorio

1/4



Intestinal Anastomosis Clamps

Darm-Anastomosenklemmen
Clamps para anastomosis intestinales
Pincas pour anastomoses intestinale
Pinze per anastomosi intestinali



B17-136-07
8,5 cm / 3 ³/₈"

B17-136-10
11 cm / 4 ³/₈"

1/2

Stone-Watt
B17-136-07
B17-136-10



1/2

Stone-Watt
B17-137-00

Klemmschloß
Locking Device
Cierre para clamps intestinales
Serrure pour clamps intestinales
Serratura per pinze intestinali



B17-136-07
B17-136-10



1/2

Stone-Watt
B17-138-16
16 cm / 6 ²/₈"

Schließklemme
Closing Forceps
Pinza para cerrar clamps
Pinze pour fermer et porter les champs
Serrapinze e portapinze



B17-136-07
B17-136-10



Stomach and Intestinal Anastomosis Twin Clamps

Magen- und Darm-Zwillingsklemmen
Pinzas gastro-intestinales gemales
Pincas stomacales et intestinales jumelées
Pinze gastrointestinali gemelle



1/2

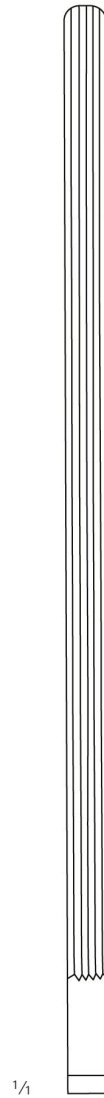

1/4



Lane
B17-139-30
30 cm / 11 ⁶/₈"

Stomach and Intestinal Anastomosis Twin Clamps

Magen- und Darm-Zwillingsklemmen

Pinzas gastro-intestinales gemelas

Pinces stomacales et intestinales jumelées

Pinze gastrointestinali gemelle



1/2

1/4

Lane

B17-140-30

30 cm / 11 5/8"



Organ Grasping Forceps

Organfasszangen
Pinzas para coger órganos
Pincas pour saisir des organes
Pinze per afferrare organi



Atrauma



1/1



B17-141-18
18 cm / 7 1/8"
schmal
narrow
estrecho
étroit
stretto

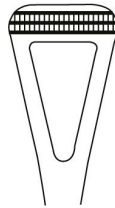

B17-141-20
20,5 cm / 8 1/8"
mittel
medium
mediano
moyen
medio

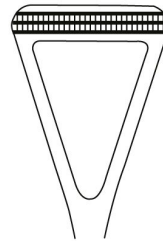

B17-141-23
23 cm / 9"
breit
wide
ancho
large
largo

1/2

Scheibe
B17-141-18
B17-141-23

Atrauma



1/2

Doyen-Baby
 B17-142-14
 B17-142-23

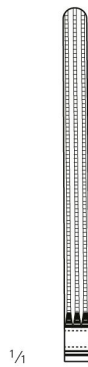

1/1

B17-142-14
 14 cm / 5 4/8"



B17-142-17
 17 cm / 6 5/8"

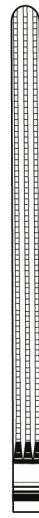

B17-142-18
 18,5 cm / 7 3/8"

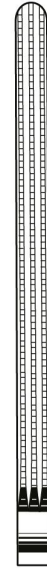

B17-142-21
 21,5 cm / 8 4/8"

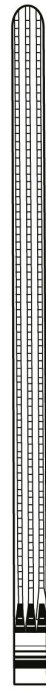

B17-142-23
 23,5 cm / 9 2/8"



1/2

Doyen-Baby
 B17-143-13
 B17-143-23

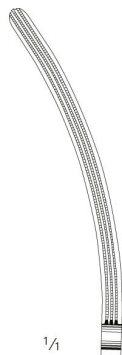

1/1

B17-143-13
 13,5 cm / 5 2/8"

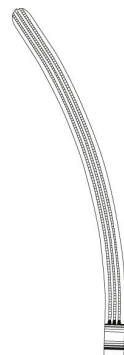

B17-143-16
 17 cm / 6 5/8"

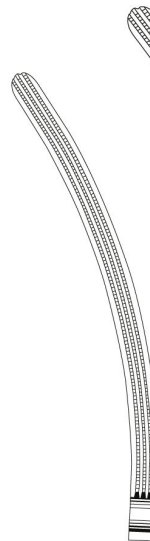

B17-143-18
 18 cm / 7"

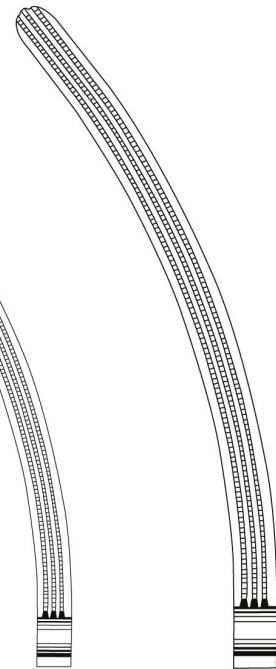

Intestinal Clamps
 Darmklemmen
 Pinzas intestinales
 Pincas intestinales
 Pinze intestinali

Atrauma



1/2

Mayo-Robson
B17-144-26
 26 cm / 10 2/8"



1/2

Mayo-Robson
B17-145-25
 25 cm / 9 2/8"



Intestinal Clamps
Darmklemmen
Pinzas intestinales
Pinze intestinali

Atrauma



1/2

Kocher
B17-146-22
B17-146-28

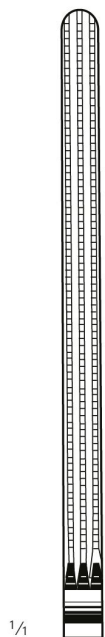

1/1

B17-146-22
22,5 cm / 8 9/16"



B17-146-25
25 cm / 9 7/8"

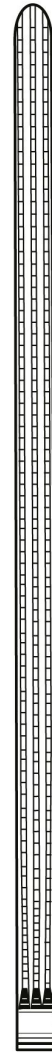

B17-146-28
28 cm / 11"

Intestinal Clamps
 Darmklemmen
 Pinzas intestinales
 Pincas intestinales
 Pinze intestinali

Atrauma



1/2

Kocher
 B17-147-22
 B17-147-27

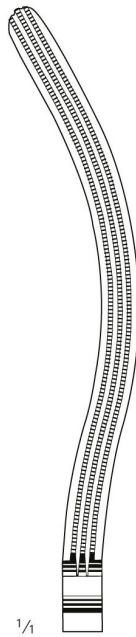
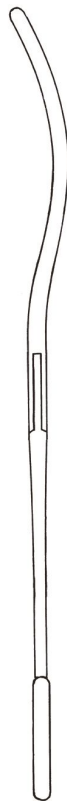

1/4

B17-147-22
 22 cm / 8 5/8"

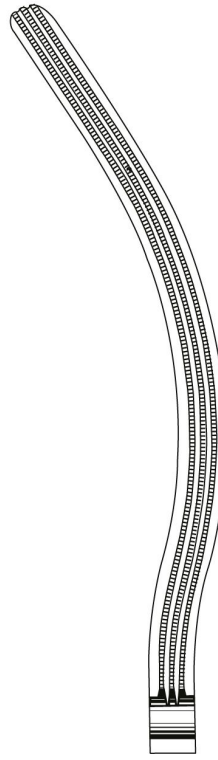

B17-147-24
 24,5 cm / 9 5/8"

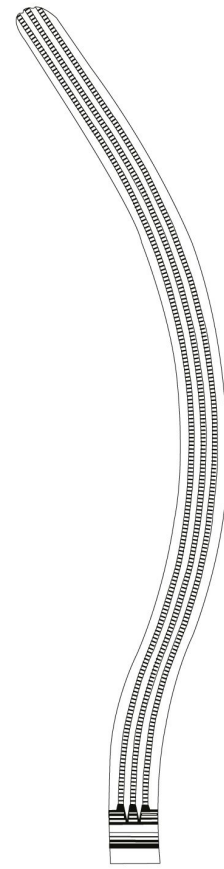

B17-147-27
 27 cm / 10 5/8"

Atrauma



B17-148-33
 33,5 cm / 13 2/8"

Scudder
 B17-148-33
 B17-149-33

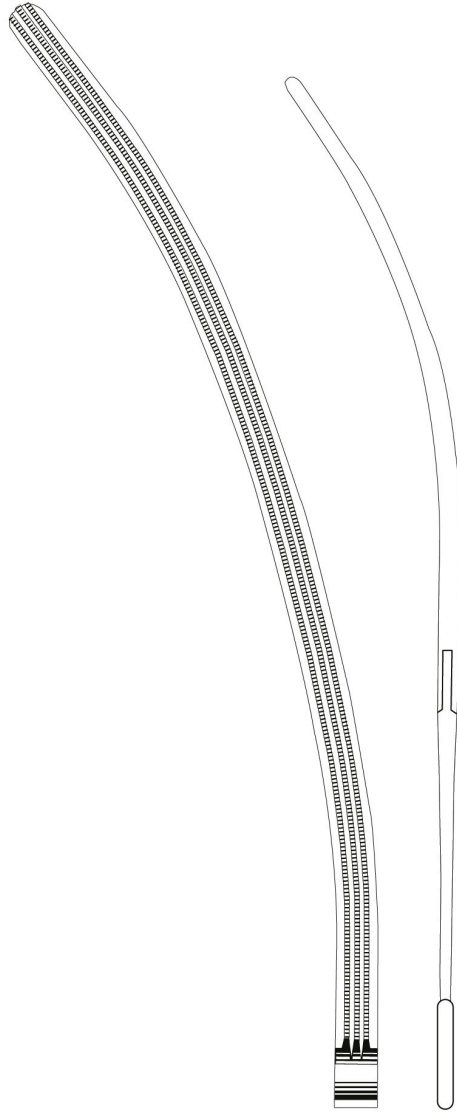

B17-149-33
 32,5 cm / 12 5/8"

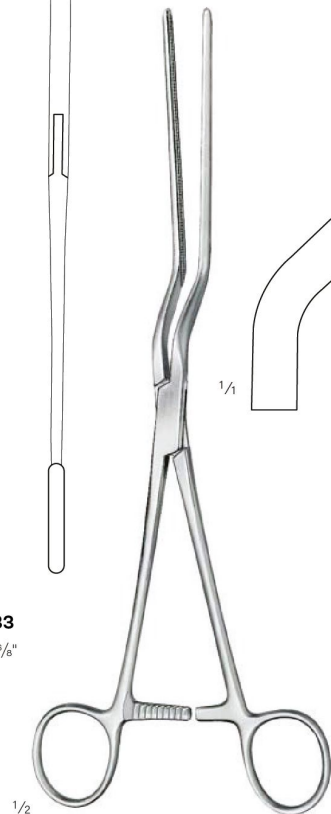

Bruner
 B17-150-27
 27 cm / 10 5/8"

Sigmoid Anastomosis Forceps
Rektum-Anastomosenklemmen
Pinzas para anastomosis rectales
Pincas pour anastomoses rectales
Pinze per anastomosi rettali

Atrauma



1/2

Hayes
B17-151-27
B17-151-28

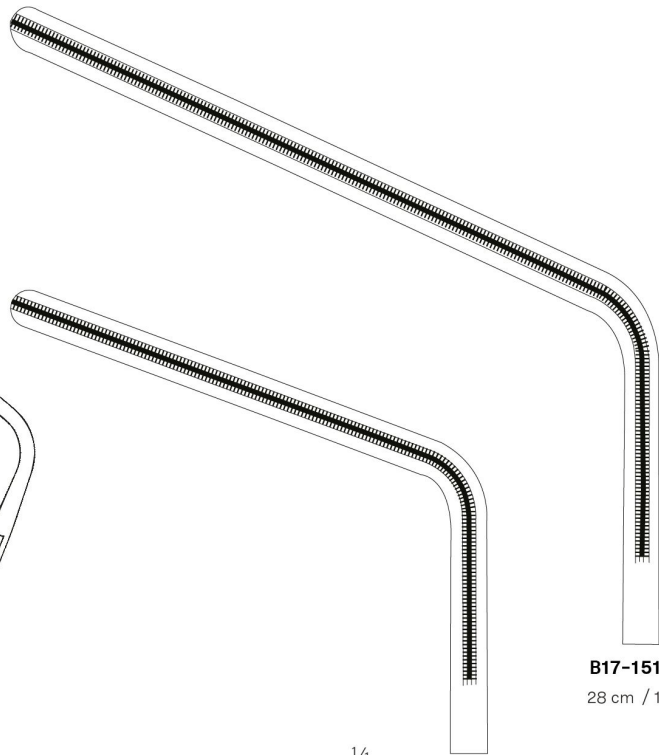
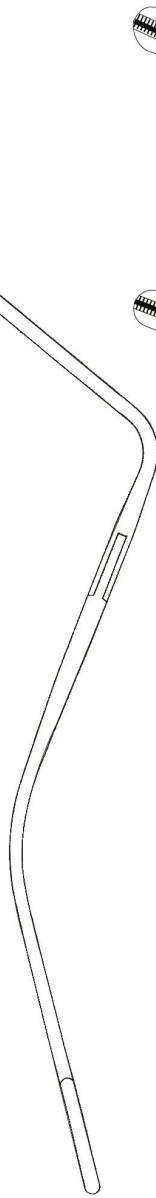

1/1

B17-151-27
27 cm / 10 5/8"

B17-151-28
28 cm / 11"



Sigmoid Anastomosis Forceps
Rektum-Anastomosenklemmen
Pinzas para anastomosis rectales
Pinces pour anastomoses rectales
Pinze per anastomosi rettili

Atrauma



Veidenheimer
B17-152-25
25 cm / 9 7/8"

Fehland
B17-153-24
24 cm / 9 4/8"

Sigmoid Anastomosis Forceps

Rektum-Anastomosenklemmen
Pinzas para anastomosis rectales
Pinces pour anastomoses rectales
Pinze per anastomosi rettali



Atrauma



1/2

1/4

Resano
B17-154-28
28 cm / 11"



Rectal Specula, Rectal Spreaders

Mastdarmspekula, Analspreizer
Espéculos rectales, Separadores rectales
Spéculums rectaux, Ecarteurs rectaux
Specoli rettali, Divaricatori rettali



Czerny
B17-155-22
22,5 cm / 8 7/8"



Sims
B17-156-15
15,5 cm / 6 1/8"



Sims
B17-157-15
15,5 cm / 6 1/8"



Pratt
B17-158-20
20 cm / 7 7/8"



Ives-Fansler
B17-159-15

Analspreizer
Rectal Spreaders
Separadores rectales
Ecarteurs rectaux
Divaricatori rettali

Arbeitslänge
working length
largo útil
longueur utile
lunghezza utile
80 mm

Rectal Spreaders
 Analspreizer
 Separadores rectales
 Ecarteurs rectaux
 Divaricatori rettali



1/2

Alan-Parks
B17-160-00
B17-160-95-98

B17-160-00
 14 cm / 5 4/8"
 ohne Kaltlichtaufsatz
 without F.O. light carrier
 sin portador de luz fría
 sans support lumière froide
 senza supporto per luce fredda



B17-160-94-98
 Paar Seitenvalven lang, Nutzlänge 95 mm
 Pair of lateral blades, long, useful length 95 mm
 Un par de valvas laterales, largas, longitud útil 95 mm
 Paire de valves latérales, longues, longueur utile 95 mm
 Coppia di valve laterali lunghe, lungh. utile 95 mm

B17-160-95-98
 Mittelvalve, Nutzlänge 95 mm
 Central Blade, useful length 95 mm
 Valva central, longitud útil 95 mm
 Valve centrale, longueur utile 95 mm
 Valva centrale, lungh. utile 95 mm

B17-160-92-98
 Flügelmutter
 Wing nut
 Tuerca de mariposal
 Ecrou à oreilles
 Madrevite ad alette

B17-160-93-98
 Paar Seitenvalven kurz, Nutzlänge 75 mm
 Pair of lateral blades, short, useful length 75 mm
 Un par de valvas laterales, cortas, longitud útil 75 mm
 Paire de valves latérales, courtes, longueur utile 75 mm
 Coppia di valve laterali corte, lungh. utile 75 mm



Sphincteroscopes, Hemorrhoidal Ligator
 Sphinkteroskope, Hämorrhoidal-Ligator
 Esfincteroscopios, Ligador para hemorroides
 Sfinctérosopes, Ligateur pour h morroides
 Sfincteroscopi, Legatore emorroidale



1/2

Kelly
B17-161-21
B17-161-27

B17-161-21
 Ø 21 mm
 Arbeitslänge
 working length
 largo útil
 longueur utile
 lunghezza utile
 50 mm

B17-161-27
 Ø 27 mm
 Arbeitslänge
 working length
 largo útil
 longueur utile
 lunghezza utile
 50 mm



1/2

B17-162-26
 Ladekonus
 Loading Cone
 Cono de carga
 Cône de charge
 Cono per caricare



Rudd
B17-163-04
B17-163-27



B17-163-04
 Ligatur-Gummiringe
 Rubber Rings
 Anillos de goma
 Anneaux en caoutchouc
 Anelli di gomma

Packung mit 100 Stück
 package of 100 pieces
 paquete con 100 piezas
 paquet avec 100 pièces
 confezione di 100 pezzi



B17-163-27

B17-163-27
 27,5 cm / 10 7/8"
 komplett mit Ladekonus
 complete with loading cone
 completo con cono de carga
 complet avec cône de charge
 completo con cono per caricare



Hemorrhoidal Ligator, Rectal Biopsy Forceps

Hämorrhoidal-Faßzange, Rektum-Biopsiefasszangen
Ligador para hemorroides, Pinzas para biopsia rectal
Ligateur pour hémorroïdes, Pinces pour biopsie rectale
Legatore emorroidale, Pinze per biopsia rettale

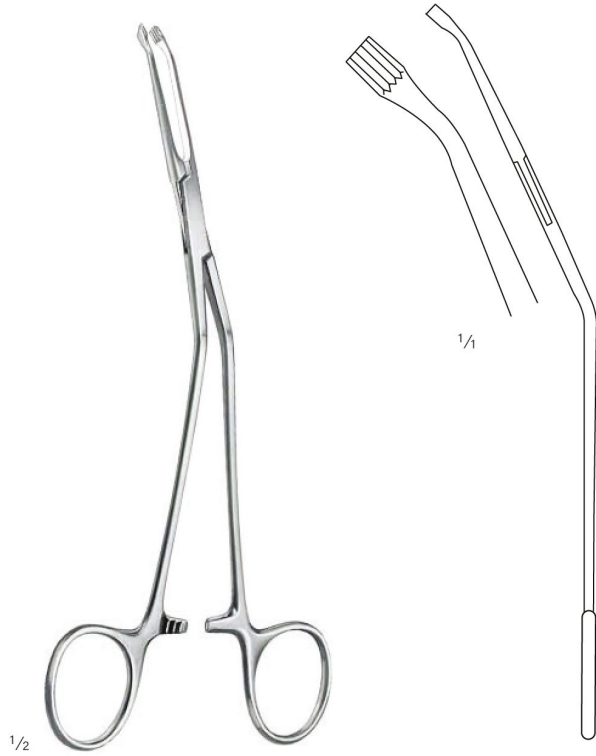

McGinvey
B17-164-19
19,5 cm / 7 5/8"

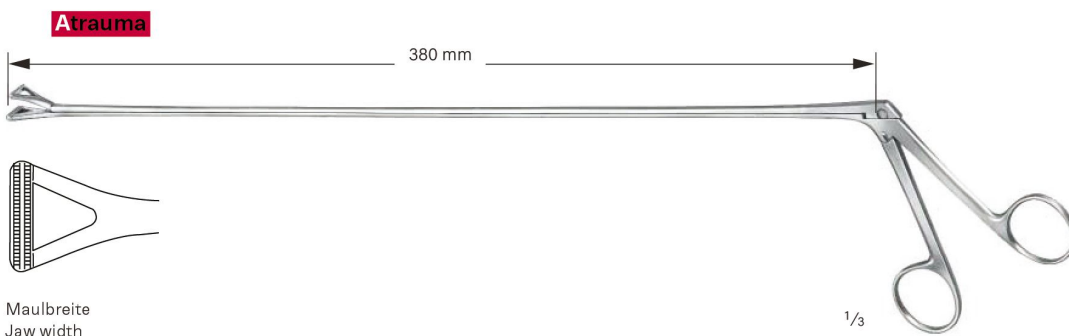

Atrauma
380 mm
Maulbreite
Jaw width
Anchura de la boca
Lageur de mors
Larghezza della bocca
15 mm

B17-165-38
38 cm / 15"



no one does it BETTER



Cell: 0092 323 9300123

Tel: 0092 52 3563378

URL: <https://bona-dent.com>

Email: info@bona-dent.com

Email: bonadent.mfg@gmail.com

Address:

Kacha Shahab Pura Road

Jeewan Pura, Sialkot (51310)

Pakistan.

