

PURIFYING LIFETIME QUALITY



EQUIPPED
AMONG
EASE

UROLOGY+



An Era Of **evolution**

Bonadent

HAS THE REPUTATION OF BEING THE ONLY IN PAKISTAN THAT MANUFACTURES ITS OWN TOOLS FOR THE PRODUCTION OF ITS INSTRUMENTS.

Bonadent is a privately owned company providing personalized services and the finest in Surgical Instruments for over 25 years. Established in 1999, Our Company manufactures a wide range of Surgical, Dental and Veterinary Instruments.

All Instruments and devices of our product range are manufactured by well-trained and experienced skilled workers with special craftsmanship and by use of most modern machines and equipment. On this occasion we only use materials which meet our high standards. The CEO of Bonadent Manufacturing co, Mr. Muhammad Ibrahim brings with him a lifetime of knowledge about the world of surgical instruments.

This insight allows us to understand the needs of our customers in a way most other instrument companies are unable to do.

After becoming a competent oem service provider, cardiac has decided to introduce itself as the original source of high quality instrumentation to directly interact with some of the well-known brands around the world.

Kidney Stone Forceps

Nierensteinzangen
Pinzas para cálculos renales
Pincas pour les calculs du bassinet
Pinze per calcoli renali



1/2

Randall
B18-101-23
B18-101-18

1/4

Fig. 1
B18-101-23
23 cm / 9"

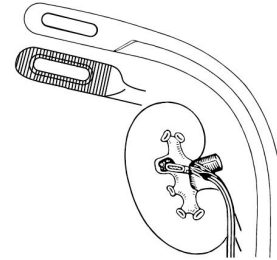
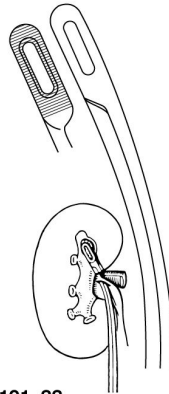

Fig. 2
B18-101-21
21 cm / 8 2/8"

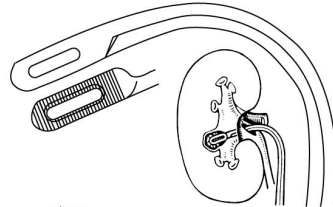

Fig. 3
B18-101-19
19 cm / 7 4/8"

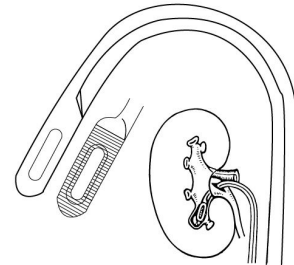

Fig. 4
B18-101-18
18,5 cm / 7 2/8"



1/2

Heiming
B18-102-16
B18-102-17

für Kinder
for children
para niños
pour enfants
per bambini

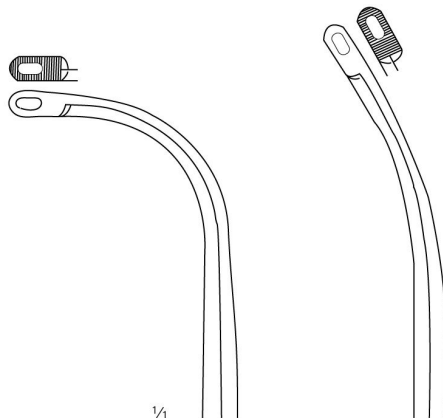

1/4

Fig. 1
B18-102-16
16 cm / 6 2/8"

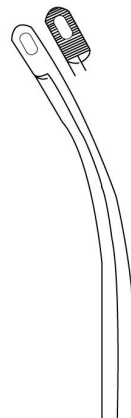

Fig. 2
B18-102-17
17 cm / 6 5/8"

Gall Duct Dilators

Gallenkanaldilatatore
 Dilatadores para conducto biliar
 Dilatateurs pour les voies biliaires
 Dilatatori per condotti biliari

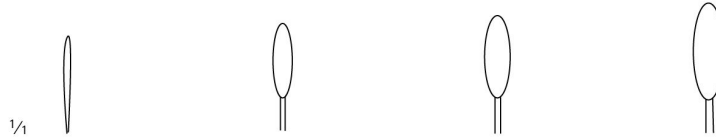

Fig. 1	Fig. 2	Fig. 3	Fig. 4
Ø 1,0 mm	Ø 2,0 mm	Ø 3,0 mm	Ø 4,0 mm
B18-103-01	B18-103-02	B18-103-03	B18-103-04

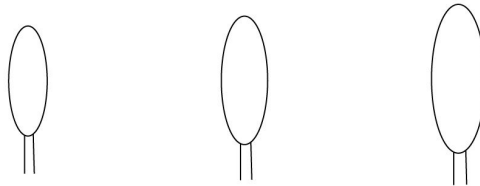

Fig. 5	Fig. 6	Fig. 7
Ø 5,0 mm	Ø 6,0 mm	Ø 7,0 mm
B18-103-05	B18-103-06	B18-103-07

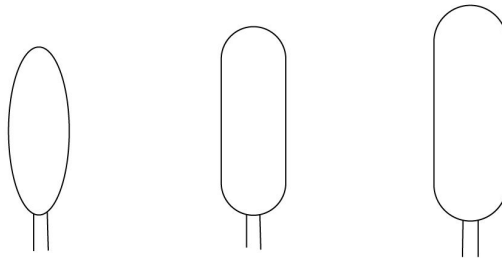

Fig. 8	Fig. 9	Fig. 10
Ø 8,0 mm	Ø 9,0 mm	Ø 10 mm
B18-103-08	B18-103-09	B18-103-10

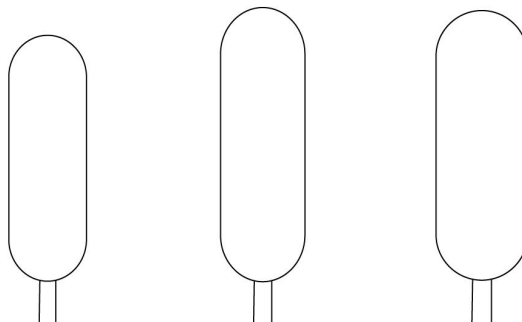

Fig. 11	Fig. 12	Fig. 13
Ø 11 mm	Ø 12 mm	Ø 13 mm
B18-103-11	B18-103-12	B18-103-13

1/2

Bakes

B18-103-01

B18-103-13

32 cm / 12 5/8"

biegsamer Schaft
 malleable shaft
 västago maleable
 tige malléable
 gambo malleabile

Gall Stone Forceps
Gallensteinzangen
Pinzas para cálculos biliares
Pincers pour calculs biliaires
Pinze per calcoli biliari



B18-104-21
21 cm / 8 2/8"

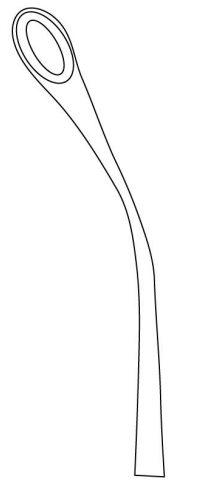

B18-104-20
20,5 cm / 8 1/8"



Mayo-Blake
B18-105-21
21 cm / 8 2/8"



Mayo-Blake
B18-106-21
21 cm / 8 2/8"

Gall Stone Forceps
 Gallensteinzangen
 Pinzas para cálculos biliares
 Pincès pour calculs biliaires
 Pinze per calcoli biliari



Mixer
B18-107-22
 22 cm / 8 5/8"



Desjardins
B18-108-23
B18-109-23
 23 cm / 9"

Fig. 1
B18-108-23

Fig. 2
B18-109-23

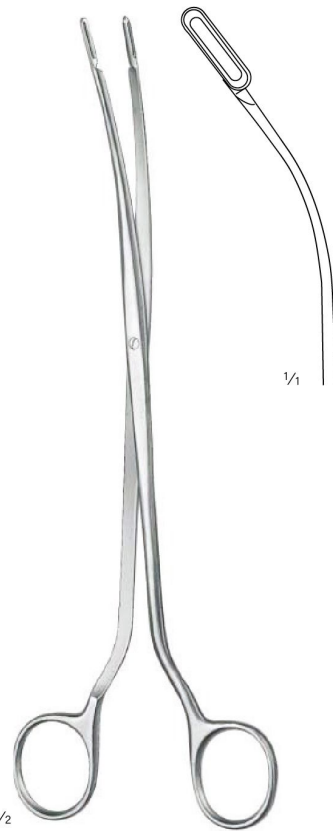

Desjardins
B18-110-22
 22,5 cm / 8 7/8"



Gall Stone Scoops
 Gallensteinlöffel
 Cucharas para cálculos biliares
 Curettes pour calculs biliaires
 Pinze per calcoli biliari



1/2

Luer-Körte

B18-111-01
B18-111-08

32 cm / 12 5/8"
 biegsamer Schaft, stumpf
 malleable shaft, blunt
 vástago maleable, romo
 tige malléable, mousse
 gambo malleabile, smusso



1/4

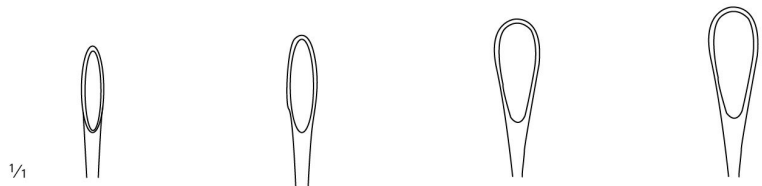

1/4

Fig. 000	Fig. 00	Fig. 0	Fig. 1
2,7 mm	3,4 mm	4,3 mm	5,5 mm
B18-111-01	B18-111-02	B18-111-03	B18-111-04

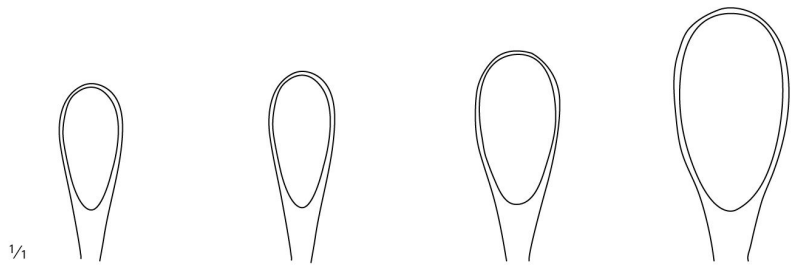

1/4

Fig. 2	Fig. 3	Fig. 4	Fig. 5
6,6 mm	8 mm	11 mm	15 mm
B18-111-05	B18-111-06	B18-111-07	B18-111-08

Prostatic Retractors

Prostatahaken
Separadores para próstata
Ecarteurs prostatiques
Divaricatori prostatici

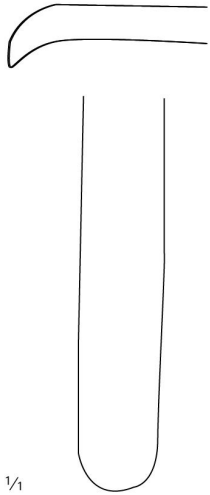

1/1

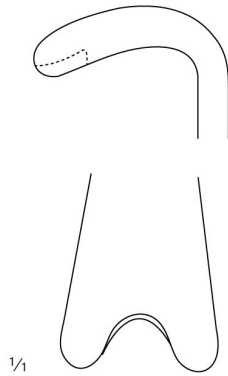

1/1

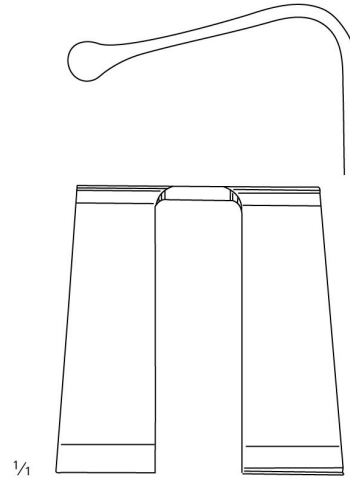

1/1



1/2

12,5 mm

Young

B18-112-22

22 cm / 8 5/8"



1/2

24 mm

Young

B18-113-22

22 cm / 8 5/8"



1/2

41 mm

Young

B18-114-23

23 cm / 9"



Capsule Forceps
Kapselfasszangen
Pinzas capsulares
Pincers pour saisir les capsules
Pinze per afferrare capsule

Atrauma



Millin
B18-115-24
24,5 cm / 9 5/8"

Atrauma



Millin
B18-116-22
22,5 cm / 8 7/8"



Millin
B18-117-24
24,5 cm / 9 5/8"



Capsule Forceps, Ligature Carrying Forceps
 Kapselfasszange, Fadenführungszange
 Pinzas capsulares, Pinza porta ligaduras
 Pincés pour saisir les capsules, Pince porte-fil
 Pinze per afferrare capsule, Pinza porta-filo



Millin
B18-118-22
 22 cm / 8 5/8"



Millin
B18-119-24
 24 cm / 9 4/8"

Bladder Neck Spreader, Bladder Retractors

Blasenhalsperrer, Blasenwundsperrer
Dilatador para el cuello vesical, Separadores vesicales
Ecarteur pour le col de la vessie, Ecarteurs vésicaux
Divaricatore del collo vescicale/Divaricatore vescicale



1/2

Millin
B18-120-28
28 cm / 11"



1/2

Judd-Masson
B18-121-00



Bladder Retractors
 Blasenwundsperrer
 Separadores vesicales
 Ecarteurs vésicaux
 Divaricatore vescicale



1/2

Millin

B18-122-00

komplett, mit je 2 Seitenvalven
 57 x 25 mm und 80 x 25 mm, sowie
 einer 1 Mittelvalve 120 x 45 mm

complete, with 2 pairs of lateral
 blades 57 x 25 mm and 80 x 25 mm,
 and 1 central blade 120 x 45 mm

completo, con 2 pares de valvas
 laterales 57 x 25 mm y 80 x 25 mm y
 una valva central 120 x 45 mm,

complet, avec 2 paires de valvas
 latérales 57 x 25 mm et 80 x 25 mm
 et 1 valve centrale 120 x 45 mm,

completo, con 2 paia di valve laterali
 57 x 25 mm e 80 x 25 mm in più 1
 valva centrale 120 x 45 mm,



57 x 25 mm

B18-122-90-98

Seitenvalven
 Lateral Blades
 Valvas laterales
 Valves laterales
 Valve laterali



80 x 25 mm

B18-122-91-98

Seitenvalven
 Lateral Blades
 Valvas laterales
 Valves laterales
 Valve laterali

120 x 45 mm

B18-122-92-98

Mittelvalve
 Central Blade
 Valva central
 Valve centrale
 Valva centrale



Urethral Sounds

Harnröhrenbougies
Bujías uretrales
Bougies urétrales
Candelette dilatatrici

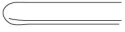
1/4 



1/2

Van Buren

B18-123-08

B18-123-36

27 cm / 10 5/8"

Charrière	Van Buren
8	B18-123-08
10	B18-123-10
12	B18-123-12
14	B18-123-14
16	B18-123-16
18	B18-123-18
20	B18-123-20
22	B18-123-22
24	B18-123-24
26	B18-123-26
28	B18-123-28
30	B18-123-30
32	B18-123-32
34	B18-123-34
36	B18-123-36

B18-123-00

Satz komplett, 8 - 36 Charrière
complete set, 8 - 36 Charrière
juego completo, 8 - 36 Charrière
jeu complet, 8 - 36 Charrière
set completo, 8 - 36 Charrière

1/4 



1/2

Guyon

B18-124-10

B18-124-30

26,5 cm / 10 3/8"

Charrière	Guyon
10	B18-124-10
11	B18-124-11
12	B18-124-12
13	B18-124-13
14	B18-124-14
15	B18-124-15
16	B18-124-16
17	B18-124-17
18	B18-124-18
19	B18-124-19
20	B18-124-20
21	B18-124-21
22	B18-124-22
23	B18-124-23
24	B18-124-24
25	B18-124-25
26	B18-124-26
27	B18-124-27
28	B18-124-28
29	B18-124-29
30	B18-124-30



Catheters

Katheter
Sondas
Sondes
Sonde



Charrière	
13	B18-125-13
15	B18-125-15



B18-125-13

B18-125-15

15 cm / 5 7/8"

Metallkatheter für Frauen

Metal Catheters, female

Sondas metálicas, femeninas

Sondes métalliques, pour femmes

Sonde metalliche, per donne



Urethrotome
Urethrotom
Uretrótomo
Urétrótome
Uretrotomi

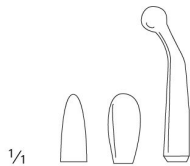

1/4

B18-126-90-98

3 Ansätze allein
3 tips only
3 puntas suelta
3 embouts seul
3 punte solo



Otis

B18-126-00

komplett im Holzetui, mit Dilator, 2 Messern und 3 Ansätzen
complete in wooden case, with dilator, 2 knives and 3 tips
completo en caja de madera, con dilatador, 2 cuchillos y 3 puntas
complet en boîte de bois, avec dilateur, 2 lames et 3 embouts
completo in contenitore di legno, con dilatatore, 2 bisturi e 3 punte



1/2



1/2

Otis

B18-127-00

Ersatzmesser
Spare Blade
Cuchillo de repuesto
Couteau de rechange
Lama di ricambio



B18-126-00



Urethrography- and Circumcision Instruments

Urethrographie- u. Circumcisions-Instrumente
Instrumentos para uretrografía y circuncisión
Instruments pour uréthrographie et circoncision
Strumenti per uretrografia e circoncisione



1/2

Knutson

B18-128-00

Urethrographieinstrument
Urethrography Instrument
Instrumento para uretrografía
Instrument pour uréthrographie
Strumento per uretrografia



1/2

Knutson-Koch

B18-129-00

Konus, allein
Cone, only
Cono, suelto
Cône, seul
Cono, solo

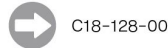

1/2

B18-130-08

B18-130-32

Circumcisionsgerät
Circumcision Instrument
Instrumento para circuncisión
Instrument de circoncision
Strumento per circoncisione

	Ø
B18-130-08	8 mm
B18-130-11	11 mm
B18-130-13	13 mm
B18-130-16	16 mm
B18-130-21	21 mm
B18-130-26	26 mm
B18-130-32	32 mm



1/2

Mogen

B18-131-00

7,5 cm / 3 "

Beschneidungsinstrument
Circumcision Instrument
Instrumento para circuncisión
Instrument de circoncision
Strumento per circoncisione



Foreign Body Forceps
 Fremdkörperzangen
 Pinzas para cuerpos extraños
 Pinces pour corps étrangers
 Pinze per corpi estranei

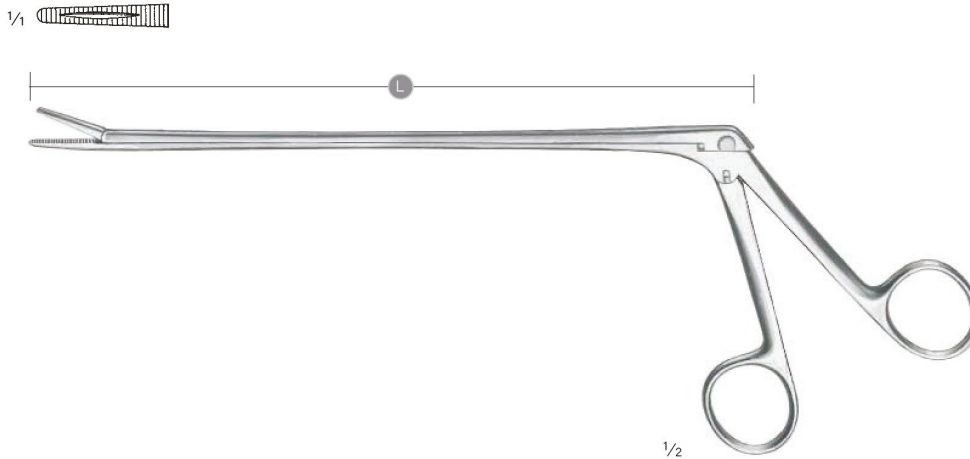

Mathieu
B18-132-20

Schaftlänge
 shaft length
 longitud del vástago
 longueur de la tige
 lunghezza dell'asta
 200 mm

Mathieu
B18-132-28

Schaftlänge
 shaft length
 longitud del vástago
 longueur de la tige
 lunghezza dell'asta
 300 mm

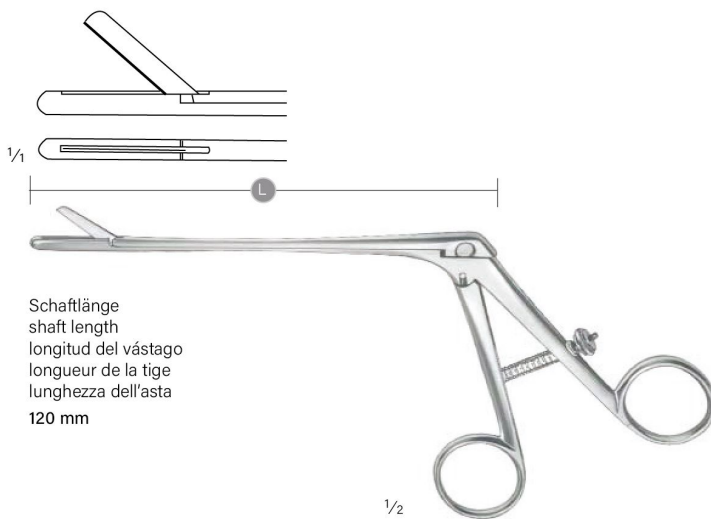

Schaftlänge
 shaft length
 longitud del vástago
 longueur de la tige
 lunghezza dell'asta
 120 mm

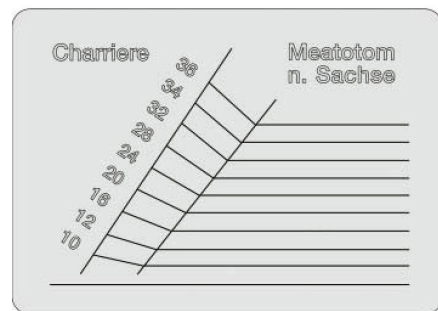

Sachse
B18-133-12

Meatotom
 Meatotome
 Meatótomo
 Méatotome
 Meatotomo

Sachse
B18-134-00

Messlehre
 Gauge
 Calibre
 Calibre
 Calibro



Penis Clamps

Penisklemmen
Clamps para pene
Pinces pour pénis
Serrapene



1/2

Stockmann
B18-135-08
8 cm / 3 1/8"



1/2

Strauss
B18-136-11
11 cm / 4 3/8"

B18-137-90-98

1 Paar Schläuche allein
1 pair of flexible tubes only
1 par de mangueras individuales
1 paire de tubes flexibles, seuls
1 coppia di tubi flessibili singoli



no one does it BETTER



Cell: 0092 323 9300123

Tel: 0092 52 3563378

URL: <https://bona-dent.com>

Email: info@bona-dent.com

Email: bonadent.mfg@gmail.com

Address:

Kacha Shahab Pura Road

Jeewan Pura, Sialkot (51310)

Pakistan.

