

COMPASSIONATE TREATMENT

• HIGH
DOSE
CARE



OTOLOGY +



An Era Of **evolution**

Bonadent

HAS THE REPUTATION OF BEING THE ONLY IN PAKISTAN THAT MANUFACTURES ITS OWN TOOLS FOR THE PRODUCTION OF ITS INSTRUMENTS.

Bonadent is a privately owned company providing personalized services and the finest in Surgical Instruments for over 25 years. Established in 1999, Our Company manufactures a wide range of Surgical, Dental and Veterinary Instruments.

All Instruments and devices of our product range are manufactured by well-trained and experienced skilled workers with special craftsmanship and by use of most modern machines and equipment. On this occasion we only use materials which meet our high standards. The CEO of Bonadent Manufacturing co, Mr. Muhammad Ibrahim brings with him a lifetime of knowledge about the world of surgical instruments.

This insight allows us to understand the needs of our customers in a way most other instrument companies are unable to do.

After becoming a competent oem service provider, cardiac has decided to introduce itself as the original source of high quality instrumentation to directly interact with some of the well-known brands around the world.

Micro Ear Forceps

Mikro-Ohrzängchen
 Micro pinzas auriculares
 Micro Pinze auriculaires
 Micro Pinze auricolari

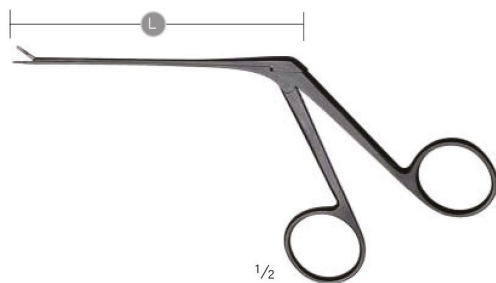
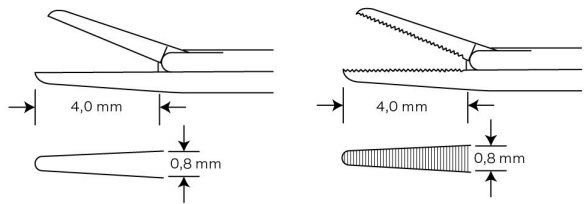

B22-100-08
B22-104-08

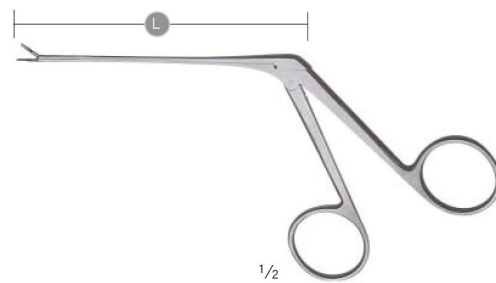

B22-105-08
B22-109-08

1/1	gerade, glatt straight, smooth recta, lisa droite, lisse retta, liscia	gerade, gerieft straight, serrated recta, estriada droite, striée retta, con scanalatura	aufgebogen, gerieft bent upwards, serrated curva por arriba, estriada courbée v. le haut, striée curva in alto, con scanalatura	rechts, gerieft right, serrated derecha, estriada droite, striée destra, con scanalatura	links, gerieft left, serrated izquierda, estriada gauche, striée sinistra, con scanalatura
	L	8 cm	8 cm	8 cm	8 cm
SB	B22-100-08	B22-101-08	B22-102-08	B22-103-08	B22-104-08
St	B22-105-08	B22-106-08	B22-107-08	B22-108-08	B22-109-08

Micro Ear Forceps
 Mikro-Ohrzängchen
 Micro pinzas auriculares
 Micro Pinze auricolaires
 Micro Pinze auricolari

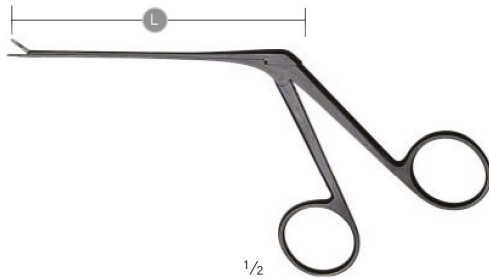
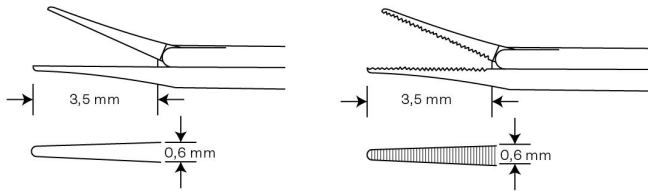

Mini-McGee
 B22-110-08
 B22-111-08

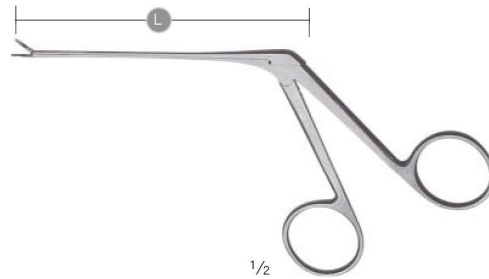

Mini-McGee
 B22-112-08
 B22-113-08

1/4	gerade, glatt straight, smooth recta, lisa droite, lisse retta, liscia	gerade, gerieft straight, serrated recta, estriada droite, striée retta, con scanalatura
	L 8 cm	8 cm
SB	B22-110-08	B22-111-08
St	B22-112-08	B22-113-08



Micro Ear Forceps

Mikro-Ohrzängchen
Micro pinzas auriculares
Micro Pince auriculaires
Micro Pinze auricolari

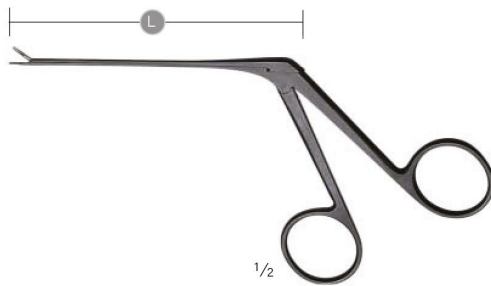
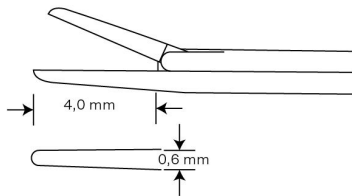

B22-114-08

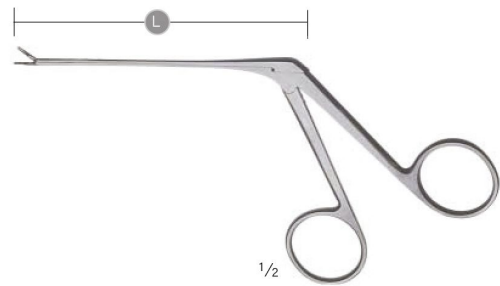

B22-115-08

1/4	gerade, glatt straight, smooth recta, lisa droite, lisse retta, liscia
	L 8 cm
SB	B22-114-08
St	B22-115-08



Micro Ear Forceps
 Mikro-Ohrzängchen
 Micro pinzas auriculares
 Micro Pince auriculaires
 Micro Pinze auricolari

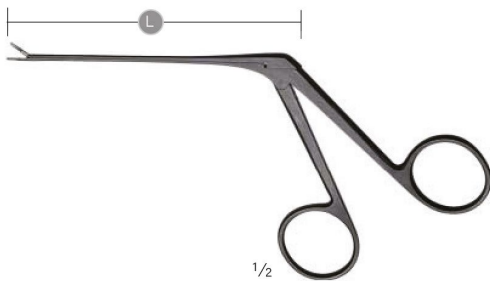
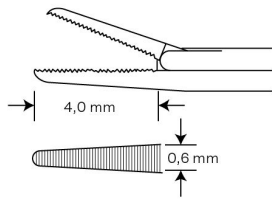
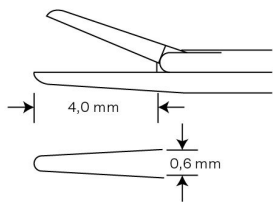

1/2

B22-116-08
B22-119-08

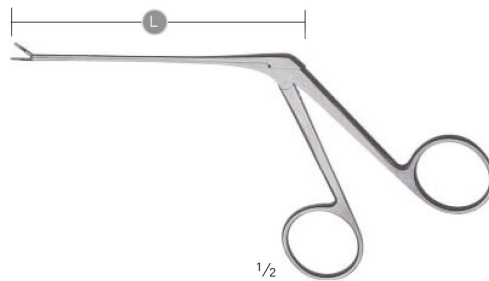

1/2

B22-120-08
B22-123-08

1/1	gerade, gerieft straight, serrated recta, estriada droite, striée retta, con scanalatura	aufgebogen, gerieft bent upwards, serrated curva por arriba, estriada courbée v. le haut, striée curva in alto, con scanalatura	rechts, gerieft right, serrated derecha, estriada droite, striée destra, con scanalatura	links, gerieft left, serrated izquierda, estriada gauche, striée sinistra, con scanalatura
L	8 cm	8 cm	8 cm	8 cm
SB	B22-116-08	B22-117-08	B22-118-08	B22-119-08
St	B22-120-08	B22-121-08	B22-122-08	B22-123-08



Micro Ear Forceps
 Mikro-Ohrzängchen
 Micro pinzas auriculares
 Micro Pince auriculaires
 Micro Pinze auricolari

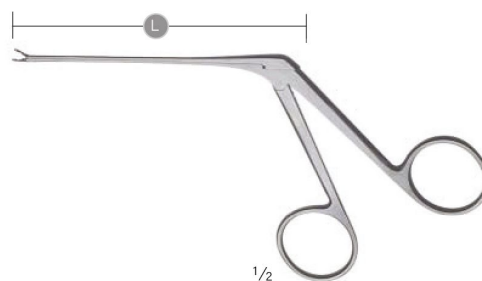
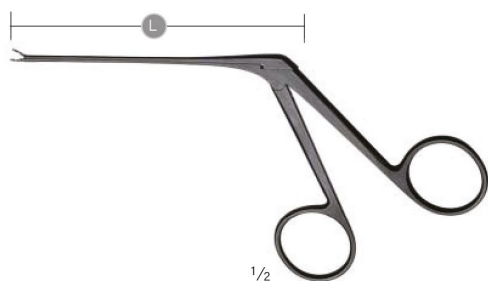
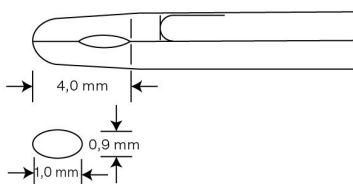

B22-124-08
B22-127-08

Löffel
 cup
 cucharilla
 curette
 cucchiaio

B22-128-08
B22-131-08

Löffel
 cup
 cucharilla
 curette
 cucchiaio

	gerade straight recta droite retta	aufgebogen bent upwards curva por arriba courbée en haut curva in alto	rechts right derecha droite destra	links left izquierda gauche sinistra
1/4				
L	8 cm	8 cm	8 cm	8 cm
SB	B22-124-08	B22-125-08	B22-126-08	B22-127-08
St	B22-128-08	B22-129-08	B22-130-08	B22-131-08

Micro Ear Forceps

Mikro-Ohrzängchen
 Micro pinzas auriculares
 Micro Pinze auriculaires
 Micro Pinze auricolari

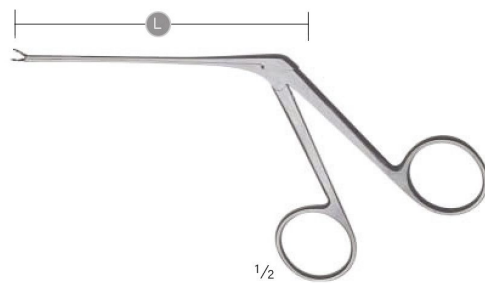
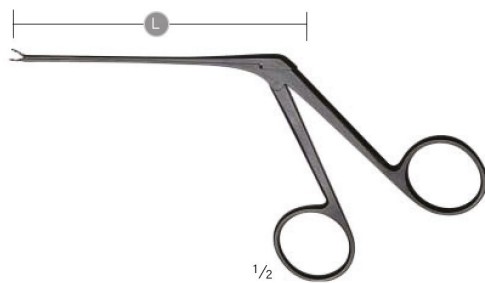
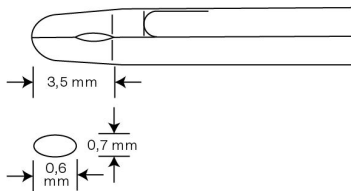

Mini-McGee

B22-132-08

B22-135-08

Löffel
 cup
 cucharilla
 curette
 cucchiaio

Mini-McGee

B22-136-08

B22-139-08

Löffel
 cup
 cucharilla
 curette
 cucchiaio

	gerade straight recta droite retta	aufgebogen bent upwards curva por arriba courbée en haut curva in alto	rechts right derecha droite destra	links left izquierda gauche sinistra
1/1				
L	8 cm	8 cm	8 cm	8 cm
SB	B22-132-08	B22-133-08	B22-134-08	B22-135-08
St	B22-136-08	B22-137-08	B22-138-08	B22-139-08



Micro Ear Scissors
 Mikro-Ohrscherchen
 Micro tijeras auriculares
 Micro Ciseaux auriculaires
 Micro Forbici auricolari

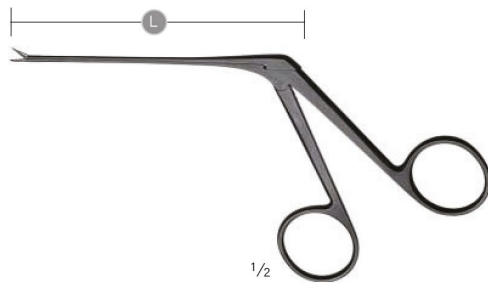
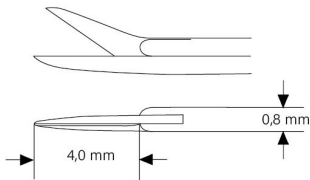

Bellucci
B22-140-08
B22-143-08

sehr fein
 very delicate
 muy fino
 très fin
 strafino

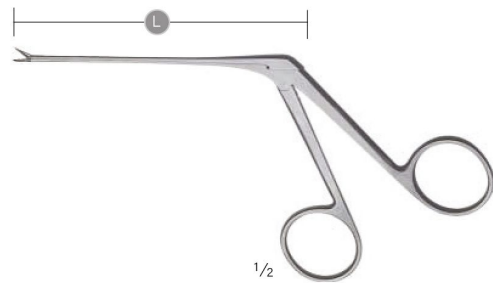

Bellucci
B22-144-08
B22-147-08

sehr fein
 very delicate
 muy fino
 très fin
 strafino

	gerade straight recta droite retta	aufgebogen bent upwards curva por arriba courbée en haut curva in alto	rechts right derecha droite destra	links left izquierda gauche sinistra
1/4				
L	8 cm	8 cm	8 cm	8 cm
SB	B22-140-08	B22-141-08	B22-142-08	B22-143-08
St	B22-144-08	B22-145-08	B22-146-08	B22-147-08

Micro Ear Scissors
 Mikro-Ohrscherchen
 Micro tijeras auriculares
 Micro Ciseaux auriculaires
 Micro Forbici auricolari

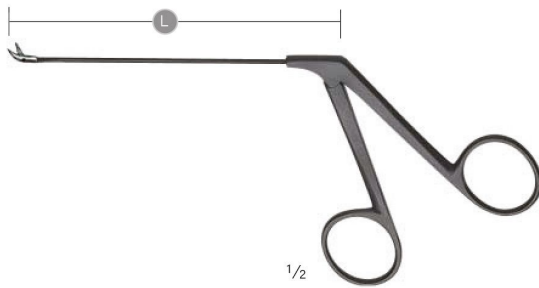
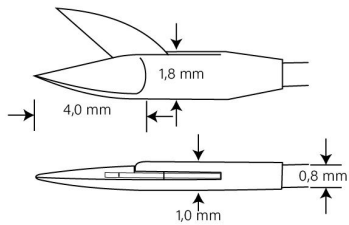

Wullstein
B22-148-09
B22-151-09

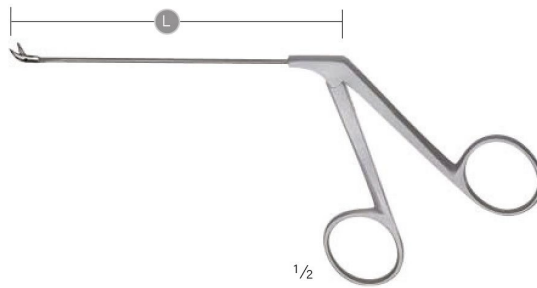

Wullstein
B22-152-09
B22-155-09

1/4	gerade straight recta droite retta	aufgebogen bent upwards curva por arriba courbée en haut curva in alto	rechts right derecha droite destra	links left izquierda gauche sinistra
L	9 cm	9 cm	9 cm	9 cm
SB	B22-148-09	B22-149-09	B22-150-09	B22-151-09
St	B22-152-09	B22-153-09	B22-154-09	B22-155-09



Micro Ear Forceps
 Mikro-Ohrzängchen
 Micro pinzas auriculares
 Micro Pince auriculaires
 Micro Pinze auricolari

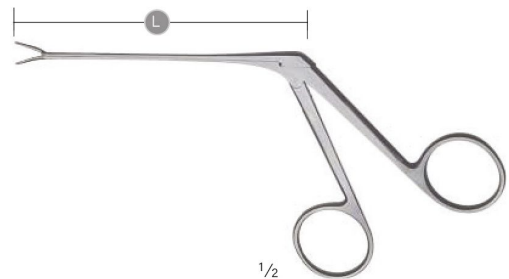
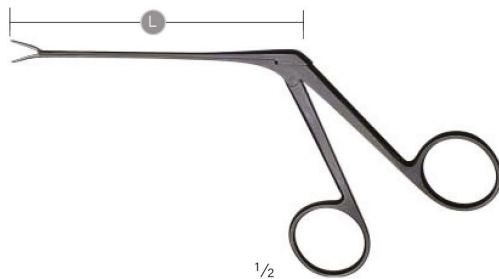
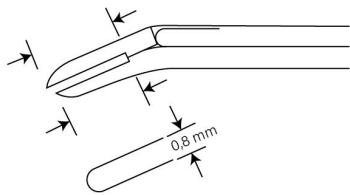

McGee

B22-156-08

B22-157-08

Drahtbiegezängchen
 Wire Bending Forceps
 Pinza para plegar alambre
 Pince à plier les fils d'acier
 Pinza per piegare fili metallici

McGee

B22-158-08

B22-159-08

Drahtbiegezängchen
 Wire Bending Forceps
 Pinza para plegar alambre
 Pince à plier les fils d'acier
 Pinza per piegare fili metallici

1/1	abgewinkelt angled downward acodado abajo angulé vers le bas angolato verso il basso	abgewinkelt angled downward acodado abajo angulé vers le bas angolato verso il basso
	3,5 mm 0,8 x 3,5 mm	6,0 mm 0,8 x 6,0 mm
L	8 cm	8 cm
SB	B22-156-08	B22-157-08
St	B22-158-08	B22-159-08

Micro Ear Forceps
 Mikro-Ohrzängchen
 Micro pinzas auriculares
 Micro Pinze auriculaires
 Micro Pinze auricolari

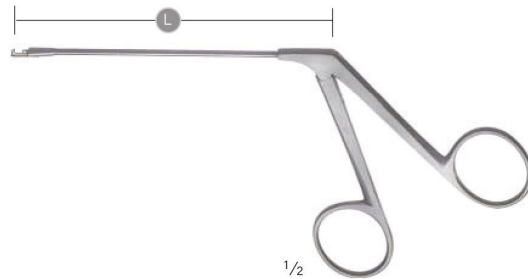
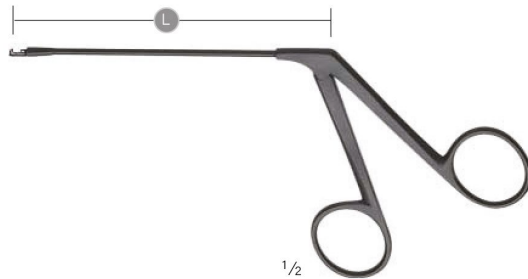
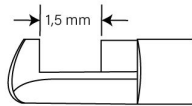

House-Dieter

B22-160-09

B22-163-09

Hammerkopfzängchen
 Malleus Nipper
 Pinza para cabezal del maléolo
 Pince pour l'os marteau
 Pinza per testa del martelletto

House-Dieter

B22-164-09

B22-167-09

Hammerkopfzängchen
 Malleus Nipper
 Pinza para cabezal del maléolo
 Pince pour l'os marteau
 Pinza per testa del martelletto

	oben schneidend up-cutting corte arriba tranchante en haut tagliente in alto	unten schneidend down-cutting corte abajo tranchante en bas tagliente in basso	rechts schneidend right-cutting corte derecho tranchant à droite tagliente a destra	links schneidend left-cutting corte izquierdo tranchant à gauche tagliente a sinistra
1/4				
L	9 cm	9 cm	9 cm	9 cm
SB	B22-160-09	B22-161-09	B22-162-09	B22-163-09
St	B22-164-09	B22-165-09	B22-166-09	B22-167-09



Micro Ear Forceps
Mikro-Ohrzängchen
Micro pinzas auriculares
Micro Pince auriculaires
Micro Pinze auricolari

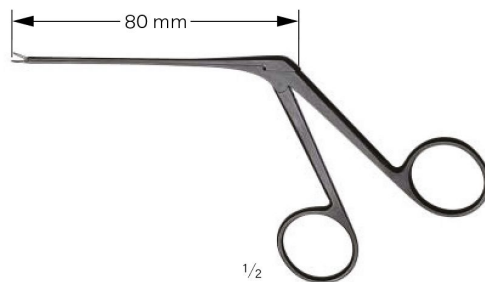
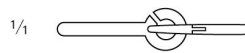

Fuller

B22-168-08

SB

Einführungszängchen, für Teflonprothesen
Introducing Forceps, for teflon prosthesis
Pinza para introducir, para prótesis de teflon
Pince pour introduction, pour prothèse en téflon
Pinza per introduzione, per protesi in teflon

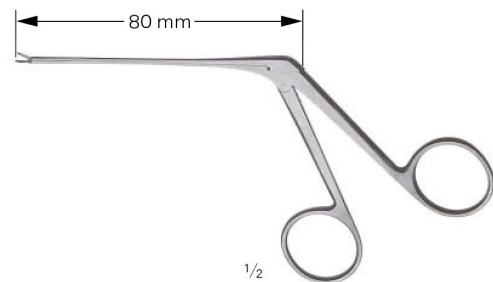

Fuller

B22-169-08

St

Einführungszängchen, für Teflonprothesen
Introducing Forceps, for teflon prosthesis
Pinza para introducir, para prótesis de teflon
Pince pour introduction, pour prothèse en téflon
Pinza per introduzione, per protesi in teflon



Micro Ear Knives
 Mikro-Ohrmesser
 Micro cuchillos auriculares
 Micro Couteaux auriculaires
 Micro Coltelli



Schuknecht
B22-170-14
 14,5 cm / 5 7/8"
 Sichelmesser
 Sickle Knife
 Cuchillo de hoz
 Synéchiotome
 Coltello falcato
 come sinechia



Wullstein
B22-171-15
 15,5 cm / 6 1/8"
 Sichelmesser
 Sickle Knife
 Cuchillo de hoz
 Synéchiotome
 Coltello falcato
 come sinechia



Tabb
B22-172-15
 15,5 cm / 6 1/8"
 Schleimhautmesser
 Mucosa Knife
 Cuchillo para mucosa
 Couteau pour muqueuse
 Bisturi per mucosa



Plester
B22-173-15
 15 cm / 5 7/8"
 Lappenmesser
 Flap Knife
 Cuchillo para lóbulos
 Couteau lobaire
 Coltello per lobi



Rosen
B22-174-01
B22-174-07
 15 cm / 5 7/8"

B22-174-01	Fig. 1	Ø 3,0 mm	
B22-174-02	Fig. 2	Ø 2,8 mm	
B22-174-03	Fig. 3	Ø 2,6 mm	
B22-174-04	Fig. 4	Ø 2,0 mm	
B22-174-05	Fig. 5	Ø 1,6 mm	
B22-174-06	Fig. 6	Ø 1,4 mm	
B22-174-07	Fig. 7	Ø 1,0 mm	



Micro Ear Hooks, Micro Ear Needles

Mikro-Ohrhäkchen, Mikro-Ohrnadeln
 Micro ganchitos auriculares, Micro agujas auriculares
 Micro Crochets auriculaires, Micro Aiguilles auriculaires
 Micro Uncini auricolari, Micro Aghi auricolari



1/4

Barbara
B22-175-01



Barbara
B22-175-02



Barbara
B22-175-03



Rosen
B22-175-04



1/4

25°
 Haken
 hook
 gancho
 crochet
 gancio

B22-175-05	0,3 mm
B22-175-06	0,6 mm
B22-175-07	1,0 mm



45°
 Haken
 hook
 gancho
 crochet
 gancio

B22-175-08	0,3 mm
B22-175-09	0,6 mm
B22-175-10	1,0 mm
B22-175-11	1,2 mm
B22-175-12	1,5 mm
B22-175-13	2,0 mm
B22-175-14	2,5 mm



90°
 Haken
 hook
 gancho
 crochet
 gancio

B22-175-15	0,3 mm
B22-175-16	0,6 mm
B22-175-17	1,0 mm
B22-175-18	1,2 mm
B22-175-19	1,5 mm
B22-175-20	2,0 mm
B22-175-21	2,5 mm



B22-175-22	0,5 mm
B22-175-23	1,0 mm

1/2



B22-175-01
B22-175-23
 16 cm / 6 2/8"

Micro Ear Hooks, Micro Ear Needles

Mikro-Ohrhäkchen, Mikro-Ohrnadeln
 Micro ganchitos auriculares, Micro agujas auriculares
 Micro Crochets auriculaires, Micro Aiguilles auriculaires
 Micro Uncini auricolari, Micro Aghi auricolari



aufgewinkelt
bent upwards
angulado hacia arriba
coudé en haut
angolato in alto
90°

- B22-176-01** 0,3 mm
- B22-176-02** 0,6 mm
- B22-176-03** 1,0 mm

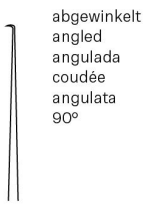

abgewinkelt
angled
angulada
coudée
angulata
90°

- B22-177-01** 0,3 mm
- B22-177-02** 0,6 mm
- B22-177-03** 1,0 mm

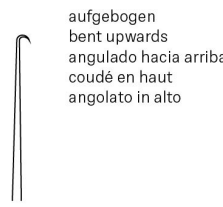

aufgebogen
bent upwards
angulado hacia arriba
coudé en haut
angolato in alto

- McGee**
- B22-178-01** 0,5 mm
 - B22-178-02** 1,0 mm

für Fußplatte
for footplate
para la platina estapediense
pour la platine de l'étrier
per la piedistallo

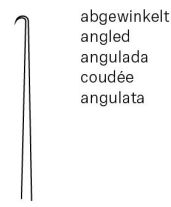

abgewinkelt
angled
angulada
coudée
angulata

- McGee**
- B22-179-01** 0,5 mm
 - B22-179-02** 1,0 mm

für Fußplatte
for footplate
para la platina estapediense
pour la platine de l'étrier
per la piedistallo

B22-176-01
B22-179-02
 15,5 cm / 6 1/8"

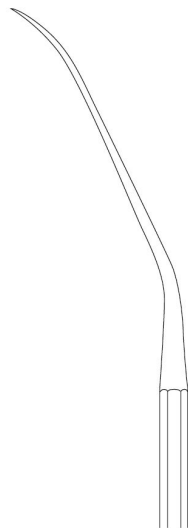
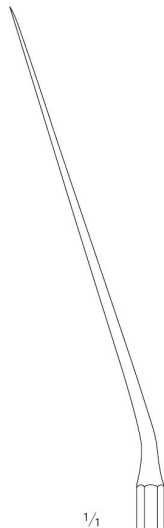

Barbara
B22-180-01
B22-180-02
 15,5 cm / 6 1/8"

B22-180-01



B22-180-02





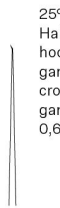
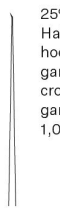
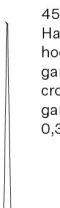
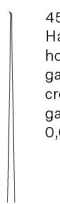
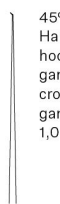
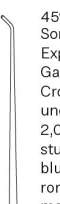
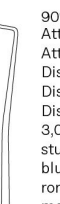

Micro Ear Hooks, Micro Dissectors

Mikro-Ohrhäkchen, Mikro-Dissektoren
 Micro ganchitos auriculares, Micro disecadores
 Micro Crochets auriculaires, Micro Dissecteurs
 Micro Uncini auricolari, Micro Dissettori

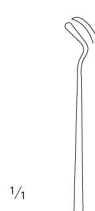
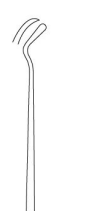
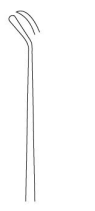

 <p>1/2</p>	 <p>1/4</p>			
	<p>25° Haken hook gancho crochet gancio 0,3 mm</p>	<p>25° Haken hook gancho crochet gancio 0,6 mm</p>	<p>25° Haken hook gancho crochet gancio 1,0 mm</p>	<p>45° Haken hook gancho crochet gancio 0,3 mm</p>
	<p>B22-181-01</p>	<p>B22-181-02</p>	<p>Shambaugh B22-181-03</p>	<p>B22-181-04</p>
				
	<p>45° Haken hook gancho crochet gancio 0,6 mm</p>	<p>45° Haken hook gancho crochet gancio 1,0 mm</p>	<p>45° Sondierhaken Exploring Hook Ganchito explorador Crochet à exploration uncino di sondaggio 2,0 mm stumpf blunt romo mousse smusso</p>	<p>90° Attikusdissektor Attic Dissector Disecador para el ático Dissecteur pour l'attique Dissettori per l'attico 3,0 mm stumpf blunt romo mousse smusso</p>
<p>B22-181-01 B22-181-08 15 cm / 5 7/8"</p>	<p>B22-181-05</p>	<p>Shambaugh B22-181-06</p>	<p>SheaAustin B22-181-07</p>	<p>B22-181-08</p>

 <p>1/2</p>	 <p>1/4</p>				 <p>1/2</p>	 <p>1,2 mm</p>
	<p>B22-182-01 15 cm / 5 7/8" nach rechts abgewinkelt angled to right angulada por derecha coudée vers droite angulata a destra</p>	<p>B22-182-02 15 cm / 5 7/8" nach links abgewinkelt angled to left angulada por izquierda coudée vers gauche angulata a sinistra</p>	<p>B22-182-03 15,5 cm / 6 1/8" nach rechts abgewinkelt angled to right angulada por derecha coudée vers droite angulata a destra</p>	<p>B22-182-04 15,5 cm / 6 1/8" nach links abgewinkelt angled to left angulada por izquierda coudée vers gauche angulata a sinistra</p>		<p>Rosen B22-183-15 15 cm / 5 7/8" Mikro-Ohrrespatorium Micro Ear Periosteal Elevator Micro Legra auricular Micro Rugine-Raspatoire auriculaire Micro Raspatore auricolare</p>

Micro Curettes, Micro Measuring Rods
 Mikro-Küretten, Mikro-Messsonden
 Micro cucharillas, Micro Sondas para medir
 Micro Curettes, Micro Sondes pour mesurer
 Micro cucchiari, Micro Sonde per misurare



1/2



1/4

B22-184-01
 Markierung bis
 Marking up to
 Manchar hasta
 Marquage jusque
 Marcatura fino a
 3,5 mm



B22-184-02
 Markierung bis
 Marking up to
 Manchar hasta
 Marquage jusque
 Marcatura fino a
 4,0 mm



B22-184-03
 Markierung bis
 Marking up to
 Manchar hasta
 Marquage jusque
 Marcatura fino a
 4,5 mm



B22-184-04
 Markierung bis
 Marking up to
 Manchar hasta
 Marquage jusque
 Marcatura fino a
 5,0 mm

House

B22-184-01
B22-184-04
 15,5 cm / 6 1/8"



1/2



Ø 1,0 mm

B22-185-01

Ø 1,2 mm

1/4



Ø 1,5 mm

B22-185-02

Ø 1,8 mm

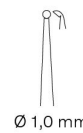
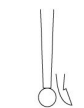

Ø 1,0 mm

B22-185-03

Ø 1,2 mm

1/4

House

B22-185-01
B22-185-03
 14,5 cm / 5 9/16"



Ear Specula
 Ohrspekula
 Espéculos auriculares
 Spéculums auriculaires
 Specoli auricolari

St



1/4

0

1

2

3

4

Fig. 0	Fig. 1	Fig. 2	Fig. 3	Fig. 4
Ø 3,0 mm	Ø 4,0 mm	Ø 5,0 mm	Ø 6,0 mm	Ø 7,5 mm
B22-186-00	B22-186-01	B22-186-02	B22-186-03	B C22-186-04

Hartmann
B22-186-00
B22-187-03
 3,6 cm / 1 3/8"

Fig. 0 - 2	Fig. 2 - 4	Fig. 1 - 4
B22-187-01	B22-187-02	B22-187-03
Ohrspekula, Satz, Ear Specula, set Espéculos auriculares, juego Spéculums auriculaires, jeu Specoli auricolari, set für Kinder for children para niños pour enfants per bambini	Ohrspekula, Satz, Ear Specula, set Espéculos auriculares, juego Spéculums auriculaires, jeu Specoli auricolari, set für Erwachsene for adults para adultos pour adultes per adulti	Ohrspekula, Satz, Ear Specula, set Espéculos auriculares, juego Spéculums auriculaires, jeu Specoli auricolari, set für Erwachsene for adults para adultos pour adultes per adulti

St



1/4

1

2

3

4

Fig. 1	Fig. 2	Fig. 3	Fig. 4
Ø 4,0 mm	Ø 5,0 mm	Ø 6,0 mm	Ø 7,5 mm
B22-188-01	B22-188-02	B22-188-03	B22-188-04

Toynbee
B22-188-01
B22-189-02
 3,6 cm / 1 3/8"

Fig. 2 - 4	Fig. 1 - 4
B22-189-01	B22-189-02
Ohrspekula, Satz, Ear Specula, set Espéculos auriculares, juego Spéculums auriculaires, jeu Specoli auricolari, set für Erwachsene for adults para adultos pour adultes per adulti	Ohrspekula, Satz, Ear Specula, set Espéculos auriculares, juego Spéculums auriculaires, jeu Specoli auricolari, set für Erwachsene for adults para adultos pour adultes per adulti

Ear Specula

Ohrspekula
Espéculos auriculares
Spéculums auriculaires
Specoli auricolari

Al



Fig. 1	Fig. 2	Fig. 3	Fig. 4	Fig. 5	Fig. 6
5,5 x 6,5 mm	6,5 x 7,5 mm	7,5 x 8,5 mm	8,5 x 9,5 mm	9,5 x 10,5 mm	10,5 x 11,5 mm
B22-190-01	B22-190-02	B22-190-03	B22-190-04	B22-190-05	B22-190-06

Zöllner

B22-190-00
B22-190-06

3,8 cm / 1 5/8"
oval, schwarz
oval, black
ovalado, negro
ovale, noire
ovale, nero

Fig. 1 - 6

B22-190-00

Ohrspekula, Satz,
Ear Specula, set
Espéculos auriculares, juego
Spéculums auriculaires, jeu
Specoli auricolari, set

St
18/8



Fig. 1	Fig. 2	Fig. 3	Fig. 4	Fig. 5	Fig. 6	Fig. 7
Ø 5,5 mm	Ø 6,5 mm	Ø 7,5 mm	Ø 8,5 mm	Ø 9,5 mm	Ø 10,5 mm	Ø 11,5 mm
B22-191-01	B22-191-02	B22-191-03	B22-191-04	B22-191-05	B22-191-06	B22-191-07

Farrior

B22-191-01
B22-191-07

3,6 cm / 1 3/8"
rund, schwarz
round, black
redondo, negro
ronde, noire
rotondo, nero



B22-192-12

Ohrspekulaständer
Ear Specula Storage Rack
Soporte para espéculos auriculares
Support pour spéculums auriculaires
Supporto per specoli auricolari



Tuning Forks
Stimmgabeln
Diapasónes
Diapasons
Diapason



1/2

French
B22-193-01
C₂ 16



1/2

French
B22-193-02
C₁ 32



1/2

Hartmann
B22-193-03
C 64



1/2

Hartmann
B22-193-04
C 128



1/2

Hartmann
B22-193-05
C¹ 256

Tuning Forks
 Stimmgabeln
 Diapasónes
 Diapasons
 Diapason



1/2

Martin
B22-194-01 AI
 C 128



1/2

Martin
B22-194-02 AI
 C 256



1/2

Martin-Alloy
B22-194-03 AI
 C 512



1/2

Martin-Alloy
B22-194-04 AI
 C 1024



1/2

Martin-Alloy
B22-194-05 AI
 C 2048



1/2

Hartmann
B22-195-01
 C 128



1/2

Hartmann
B22-195-02
 C¹ 256



1/2

Hartmann
B22-195-03
 C² 512



1/2

Hartmann
B22-195-04
 C³ 1024



1/2

Hartmann
B22-195-05
 C⁴ 2048



1/2

Hartmann
B22-195-06
 C⁵ 4096

Tuning Forks
Stimmgabeln
Diapasones
Diapasons
Diapason



1/2

Lucae
B22-196-01
C 128



1/2

Lucae
B22-196-02
C¹ 256



1/2

Lucae
B22-196-03
C² 512



1/2

Lucae
B22-196-04
C³ 1024



1/2

Lucae
B22-196-05
C⁴ 2048



1/2

Lucae
B22-196-06
C⁵ 4096

C22-196-90-98

Fuss, allein
Socket, only
Pedestal, suelto
Socle, seul
Zoccolo, solo



1/2

Lucae
B22-197-10

C 128

verschiebbar bis h
moveable up to h
regulable hasta h
réglable jusqu'à h
regolabile fino a h

1/4

B22-197-91-98

Fuss, allein
Socket, only
Pedestal, suelto
Socle, seul
Zoccolo, solo



1/2

Hartmann
B22-198-10

C 128

verschiebbar bis h
moveable up to h
regulable hasta h
réglable jusqu'à h
regolabile fino a h

1/4



1/2

B22-199-90-98

Fuss, allein
Socket, only
Pedestal, suelto
Socle, seul
Zoccolo, solo

Hartmann
B22-199-11

C¹ 256

Tuning Forks
Stimmgabeln
Diapasones
Diapasons
Diapason

B22-200-90-98

Dämpfer
Dampfer
Sordina
Curseur
Sordina
weiße Skala
white scale
balanza blanca
l'échelle graduée blanche
scala bianca



B22-201-10

B22-200-91-98

Dämpfer
Dampfer
Sordina
Curseur
Sordina
schwarze Skala
black scale
balanza negra
l'échelle graduée noire
scala nera



B22-201-10

B22-200-92-98

Rändelschraube
Knurled screw
Tornillo moleteado
Vis moletée Vite a
testa zigrinata



B22-201-10

B22-200-93-98

Gewichte, C 64
Weights, C 64
Pesas, C 64
Poids, C 64
Pesi, C 64



B22-201-10



1/2

Rydel-Seiffert
B22-201-10

C 64 / c 128

auch für Neurologie
also for neurology
también para neurología
aussi pour la neurologie
anche per neurologia



1/2

Neuro
B22-202-00

mit Hammer, Nadelrad, Pinsel und Nadel
with hammer, pinwheel, brush and needle
con martillo, rueda con espinas, cepillo y aguja
avec marteaux, roue aux épingles, brosette et aiguille
con martello, algesimetro, pennello ed ago

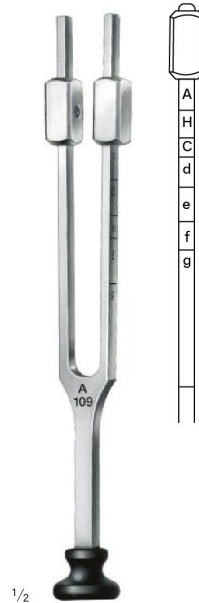

1/2

König
B22-203-59

A 109

verschiebbar bis g
moveable up to g
regulable hasta g
réglable jusqu'à g
regolabile fino a g

B22-204-90-98

Bakelitfuß
Bakelit base
Base de Bakelit
Base de Bakelit
Base di Bakelit



B22-204-61



1/2

B22-204-61

a1 440



Ear Catheters, Polypus Snares
 Ohrkatheter, Polypenschnürer
 Sondas auriculares, Polipótomos
 Sondes auriculaires, Serre-noeuds
 Sonde auricolari, Serranodi



Fig. 1	Fig. 2	Fig. 3
Ø 3,0 mm	Ø 3,5 mm	Ø 4,0 mm
B22-205-01	B22-205-02	B22-205-03

Hartmann
B22-205-01
B22-205-02
 15 cm / 5 7/8"



B22-206-11

Schaftlänge
 shaft length
 longitud del vástago
 longueur de la tige
 lunghezza dell'asta
 110 mm



Krause
B22-207-18
 18,5 cm / 7 2/8"
 offenes Ende
 open tip
 punta abierta
 pointe ouverte
 punta aperta



Krause-Voss
B22-208-18
 18,5 cm / 7 2/8"
 geschlossenes Ende
 closed tip
 punta cerrada
 pointe fermée
 punt chiusa

B22-208-90-98
 Polypenschnürer
 Polypus Snares
 Polipótomos
 Serre-noeuds
 Serranodi

➔ B22-208-18



B22-209-30
B22-209-40

Schnürdraht, Rolle mit 10 m
 Snare Wire, coil of 10 m
 Alambre, rollo de 10 m
 Serre-noeuds, en rouleaux de 10 m
 Filo in acciaio, rotolo di 10 m

➔ B22-207-18
 B22-208-18

Ear Forceps

Ohrpinzetten
Pinzas auriculares
Pinces auriculaires
Pinze auricolari

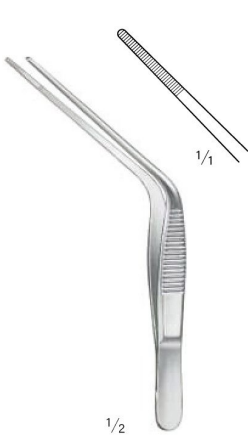

Tröltzsch (Wilde)
B22-210-10
10,5 cm / 4 1/8"



Tröltzsch (Wilde)
B22-211-11
11 cm / 4 3/8"



Tröltzsch (Wilde)
B22-212-12
12,5 cm / 4 7/8"



Grünwald
B22-213-14
14,5 cm / 5 5/8"



Jansen
B22-214-16
16 cm / 6 2/8"
B22-214-21
21,5 cm / 8 4/8"



Ear Polypus Forceps
 Ohrpolypenzangen
 Pinzas para pólipos auriculares
 Pincès pour polypes auriculaires
 Pinze per polipi auricolari

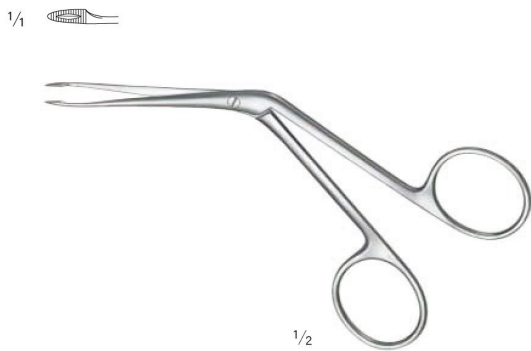

Hartmann
B22-215-12

feines Modell	Schaftlänge
delicate pattern	shaft length
modelo delicado	longitud del vástago
modèle fin	longueur de la tige
modello fino	lunghezza dell'asta
	65 mm



Hartmann
B22-216-14

normales Modell	Schaftlänge
regular model	shaft length
modelo regular	longitud del vástago
modèle normal	longueur de la tige
modello normale	lunghezza dell'asta
	65 mm



Buck
B22-217-11

11,5 cm / 4 1/8"
 Fremdkörperzängchen
 Foreign Body Lever
 Elevador para cuerpos extraños
 Pince pour polypes auriculaires
 Pinza per corpi estranei



Quire
B22-218-10

10,5 cm / 4 1/8"
 Fremdkörperhebel
 Foreign Body Lever
 Elevador para cuerpos extraños
 Pince pour corps étrangers
 Leva per corpi estranei

Ear Polypus Forceps

Ohrpolypenzangen
 Pinzas para pólipos auriculares
 Pinces pour polypes auriculaires
 Pinze per polipi auricolari

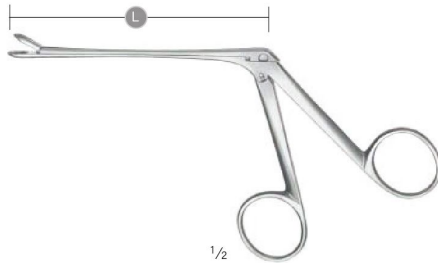

B22-219-08
B22-227-08

	Hartmann-Wullstein	Hartmann-Wullstein
1/1		
L	8,5 cm	8,5 cm
	B22-219-08	B22-220-08

	Hartmann	Hartmann
1/1		
L	8,5 cm	14 cm
	B22-221-08	B22-221-14

	Hartmann-Herzfeld	Hartmann-Herzfeld	Hartmann-Herzfeld
1/1	 Ø 2,0 mm	 Ø 2,5 mm	 Ø 3,0 mm
L	8,5 cm	8,5 cm	8,5 cm
	B22-222-08	B22-223-08	B22-224-08

	Hartmann-Wullstein	Strümpel	Hartmann-Hoffmann durchschneidend through-cutting cortante tranchante tagliante
1/1	 Ø 3,0 mm		 Ø 2,0 mm
L	8,5 cm	8,5 cm	8,5 cm
	B22-225-08	B22-226-08	B22-227-08



Mastoid Rongeurs
 Ohr-Knochenstanzen
 Pinzas cortantes para huesos
 Ostéotomes emporte-pièces
 Pinze osteotomi



1/2

Citelli
B22-228-07

Maulbreite Jaw width Anchura de la boca Largeur de mors Larghezza della bocca	 <p>1/1</p>	aufgewinkelt angled upward acodado arrib angulé vers le haut angolato verso l'alto
	L	7,5 cm
3 mm		B22-228-07



Mastoid Rongeurs
 Ohr-Knochenstanzen
 Pinzas cortantes para huesos
 Ostéotomes emporte-pièces
 Pinze osteotomi

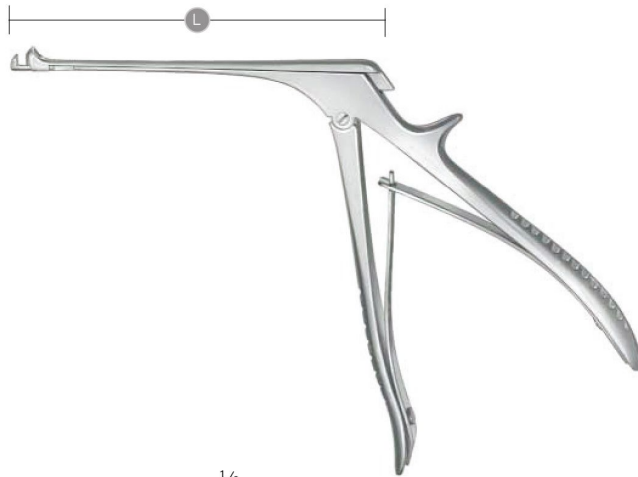

1/2

Beyer
B22-229-09
B22-230-09

Maulbreite Jaw width Anchura de la boca Largeur de mors Larghezza della bocca		aufgewinkelt angled upward acodado arrib angulé vers le haut angolato verso l'alto
	1/1	
	L	9,5 cm
1 mm	U	B22-229-09
2 mm	U	B22-230-09



Ear Curettes

Ohrküretten
Curetas auriculares
Curettes auriculaires
Curette auricolari

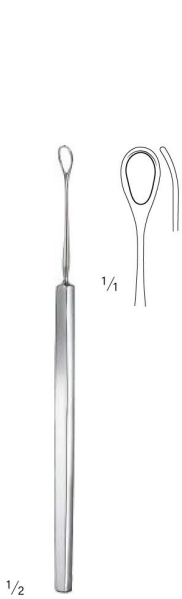

Langenbeck
B22-231-13

13 cm / 5 1/8"

stumpf
blunt
romo
mousse
smusso



Shapleigh
B22-232-01
B22-232-02

15 cm / 5 7/8"

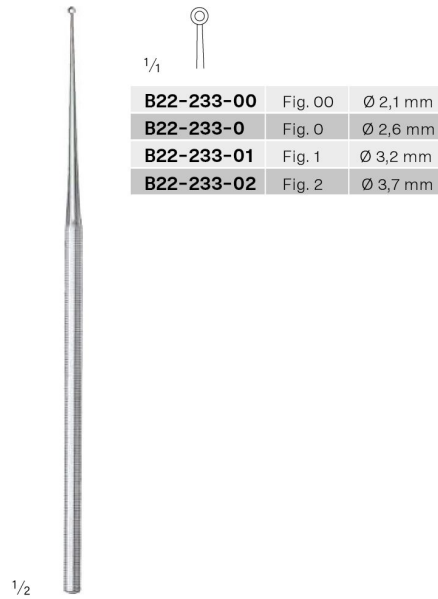

Buck
B22-233-00
B22-233-02

17 cm / 6 5/8"

stumpf
blunt
romo
mousse
smusso

B22-233-00	Fig. 00	Ø 2,1 mm
B22-233-0	Fig. 0	Ø 2,6 mm
B22-233-01	Fig. 1	Ø 3,2 mm
B22-233-02	Fig. 2	Ø 3,7 mm



Buck
B22-234-000
B22-235-04

15 cm / 6 5/8"

stumpf
blunt
romo
mousse
smusso

B22-234-000	Fig. 000	Ø 1,8 mm
B22-234-00	Fig. 00	Ø 2,1 mm
B22-234-0	Fig. 0	Ø 2,6 mm
B22-234-01	Fig. 1	Ø 3,2 mm
B22-234-02	Fig. 2	Ø 3,7 mm
B22-234-03	Fig. 3	Ø 4,1 mm
B22-234-04	Fig. 4	Ø 4,4 mm

scharf
sharp
agudo
pointu
acuto

B22-235-000	Fig. 000	Ø 1,8 mm
B22-235-00	Fig. 00	Ø 2,1 mm
B22-235-0	Fig. 0	Ø 2,6 mm
B22-235-01	Fig. 1	Ø 3,2 mm
B22-235-02	Fig. 2	Ø 3,7 mm
B22-235-03	Fig. 3	Ø 4,1 mm
B22-235-04	Fig. 4	Ø 4,4 mm

Ear Scoop, Foreign Body Instruments

Ohrlöffel, Fremdkörperinstrumente

Cucharilla auricular, Instrumentos para cuerpos extraños

Curette auriculaire, Instruments pour corps étrangers

Curetta auricolare, Strumenti per corpi estranei

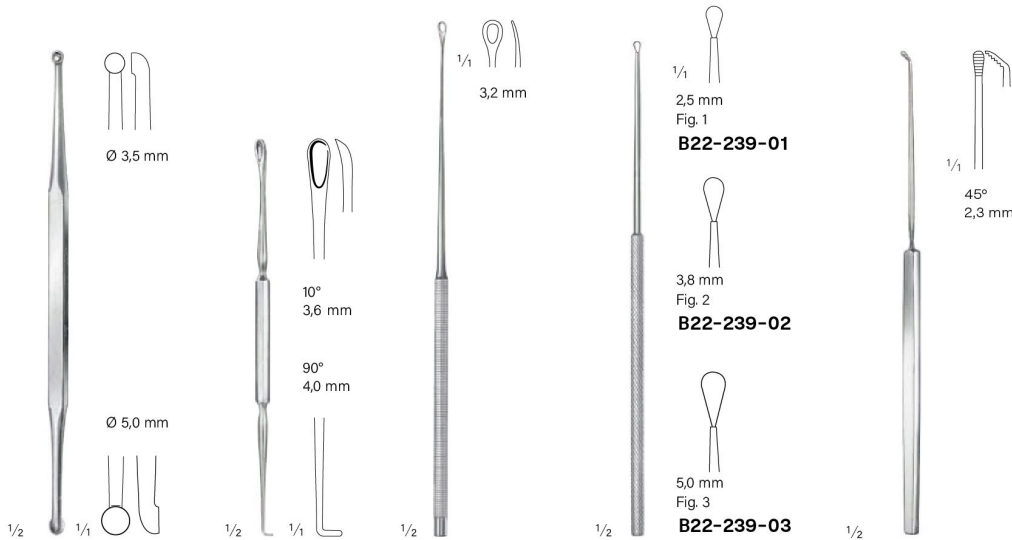

**Jansen
B22-236-16**

16 cm / 6 2/8"

scharf
sharp
agudo
pointu
acuto

**Gross
B22-237-13**

13 cm / 5 1/8"

stumpf
blunt
romo
mousse
smusso

**Weber-Loch
B22-238-17**

17 cm / 6 5/8"

stumpf
blunt
romo
mousse
smusso

**Billeau
B22-239-01
B22-239-03**

16,5 cm / 6 1/8"

**Moldenhauer
B22-240-16**

16 cm / 6 1/8"

Fremdkörperhebel
Foreign Body Lever
Elevador para cuerpos extraños
Anse auriculaire
Leva per corpi estranei



**Zaufal
B22-241-15**

15 cm / 5 7/8"

Fremdkörperhebel
Foreign Body Lever
Elevador para cuerpos extraños
Anse auriculaire
Leva per corpi estranei

**Hartmann
B22-242-16**

16 cm / 6 1/8"

Ohrhäkchen
Ear Hooklet
Ganchito auricular
Levier pour corps étrangers
Uncino auricolare

**Lucae
B22-243-01
B22-243-03**

14 cm / 5 1/2"



Ear Hooklet, Tympanum Needles

Ohrhäkchen, Trommelfellnadeln

Ganchito auricular, Aguja para tímpano

Levier pour corps étrangers, Instruments pour corps étrangers

Uncino auricolare, Strumenti per corpi estranei

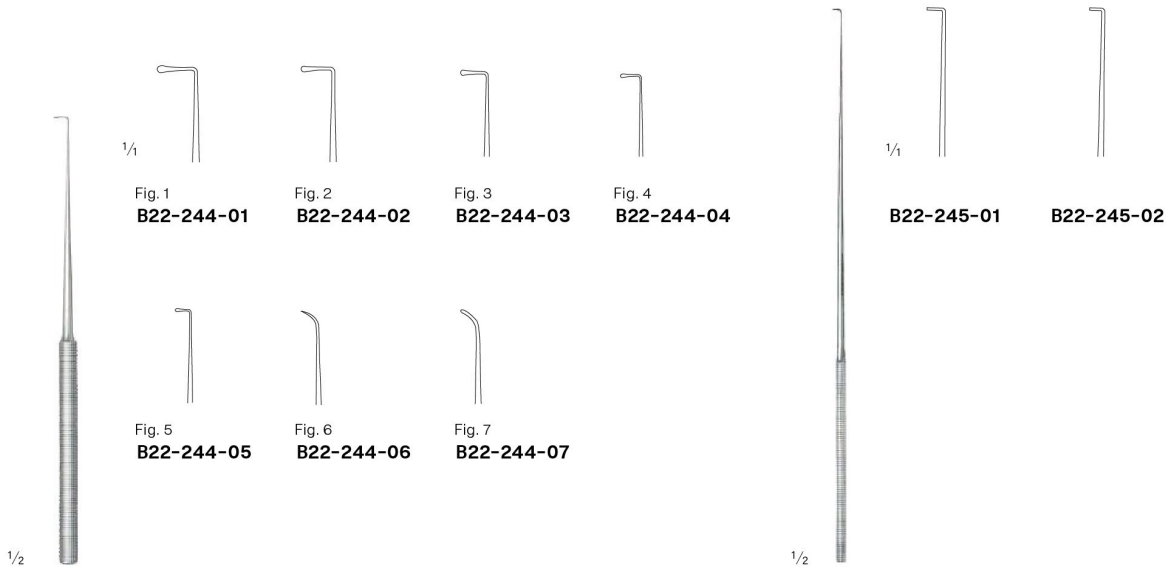

Wagener
B22-244-01
B22-244-07
 14 cm / 5 5/8"

Day
B22-245-01
B22-245-02
 17 cm / 6 5/8"

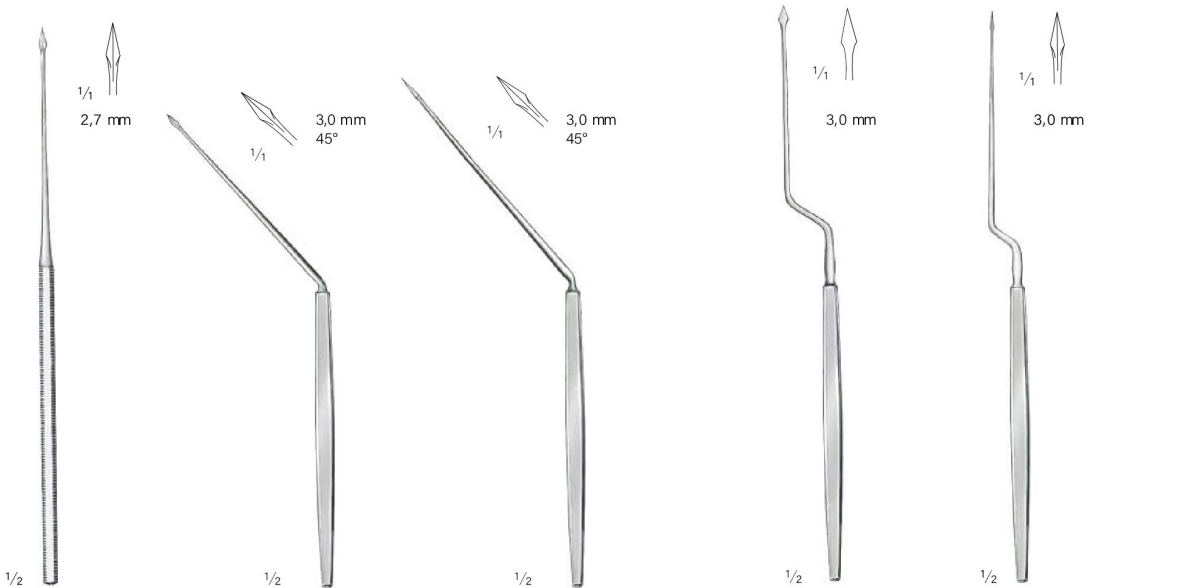

Politzer
B22-246-17
 17,5 cm / 6 7/8"

Politzer
B22-247-15
 15,5 cm / 6 1/8"
 Nadel vertikal
 needle vertically
 aguja en posición vertical
 aiguille verticale
 ago verticale

Politzer
B22-248-16
 16 cm / 6 2/8"
 Nadel horizontal
 needle horizontally
 aguja en posición horizontal
 aiguille horizontale
 ago orizzontale

Lucae
B22-249-18
 18 cm / 7 1/8"
 Nadel vertikal
 needle vertically
 aguja en posición vertical
 aiguille verticale
 ago verticale

Lucae
B22-250-17
 17,5 cm / 6 7/8"
 Nadel horizontal
 needle horizontally
 aguja en posición horizontal
 aiguille horizontale
 ago orizzontale

Ear Periosteal Elevators, Ear Scoop

Ohrraspatorien, Ohrlöffel

Legras auriculares, Cucharilla auricular

Rugines-raspatoires auriculaires, Rugine-raspatoire auriculaire

Raspatori auricolari, Curetta auricolare



Lempert
B22-251-20
20,5 cm / 8 1/8"



Lempert
B22-252-18
18 cm / 7 1/8"



Lempert
B22-253-01
B22-253-05
21,5 cm / 8 4/8"
scharf
sharp
agudo
pointu
acuto

1/4 ○
1,5 mm
Fig. 5
B22-253-05

○
2,0 mm
Fig. 4
B22-253-04

○
2,2 mm
Fig. 3
B22-253-03

○
2,5 mm
Fig. 2
B22-253-02

○
2,7 mm
Fig. 1
B22-253-01



Nasal Specula
 Nasenspekula
 Espéculos nasales
 Spéculums nasaux
 Specoli nasali



1/2

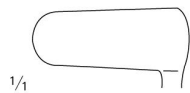

1/1

Fig. 1
B22-254-01
 Blätter
 blades
 hojas
 lames
 lame
 18,5 x 9,5 mm



Fig. 2
B22-254-02
 Blätter
 blades
 hojas
 lames
 lame
 21,0 x 10,5 mm

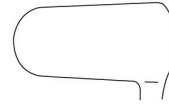

Fig. 3
B22-254-03
 Blätter
 blades
 hojas
 lames
 lame
 21,0 x 11,5 mm

Goldsmith (Thudichum)

B22-254-01
B22-254-03
 6,5 cm / 2 5/8"



1/2

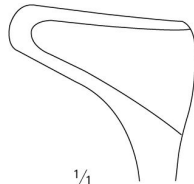

1/1

Fig. 1
B22-255-01
 Blätter
 blades
 hojas
 lames
 lame
 27 mm

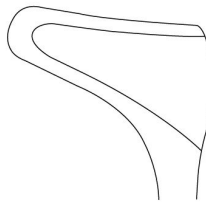

Fig. 2
B22-255-02
 Blätter
 blades
 hojas
 lames
 lame
 31 mm

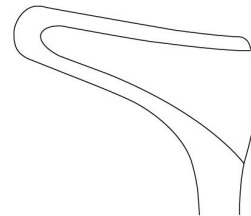

Fig. 3
B22-255-03
 Blätter
 blades
 hojas
 lames
 lame
 35 mm

Hartmann-Halle

B22-255-01
B22-255-03
 16 cm / 6 2/8"

Nasal Specula

Nasenspekula
Especulos nasales
Spéculums nasaux
Specoli nasali



1/4
Blätter
blades
hojas
lames
lame
17 mm

1/2

Martin
B22-256-13
13 cm / 5 1/8"



1/4
Blätter
blades
hojas
lames
lame
17 mm

1/2

Martin
B22-257-13
13 cm / 5 1/8"

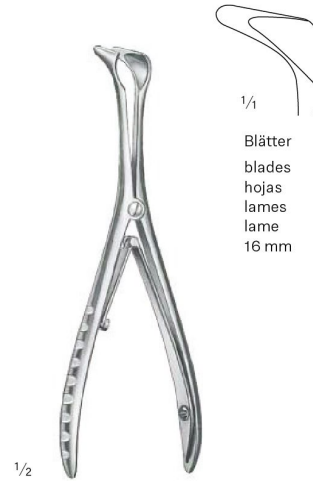

1/4
Blätter
blades
hojas
lames
lame
16 mm

1/2

Tieck-Halle
B22-258-13
13 cm / 5 1/8"



1/2

Killian
B22-259-01
B22-259-04

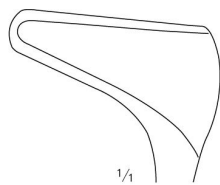

1/4

Fig. 1
B22-259-01
14 cm / 5 4/8"
Blätter
blades
hojas
lames
lame
35 mm

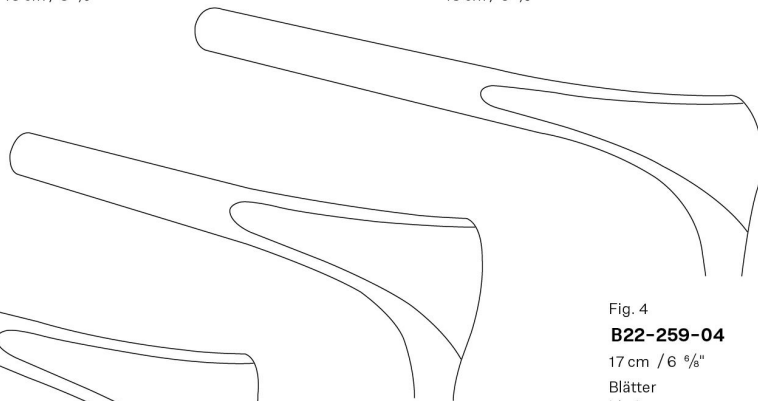

Fig. 2
B22-259-02
14,5 cm / 5 9/16"
Blätter
blades
hojas
lames
lame
50 mm

Fig. 3
B22-259-03
16 cm / 6 2/8"
Blätter
blades
hojas
lames
lame
75 mm

Fig. 4
B22-259-04
17 cm / 6 6/8"
Blätter
blades
hojas
lames
lame
85 mm



Nasal Specula

Nasenspekula
Espéculos nasales
Spéculums nasaux
Specoli nasali



1/2

Mod. Wien

B22-260-13

13,5 cm / 5 3/8"

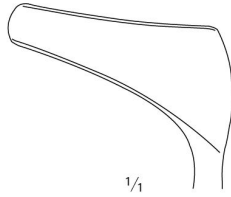

1/1

Blätter
blades
hojas
lames
lame
30 mm



1/2

Cottle

B22-261-01

B22-261-04

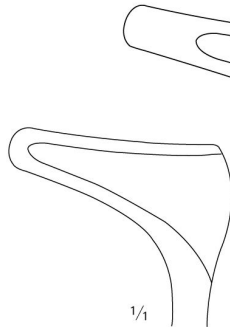

1/1

Fig. 1
B22-261-01
13,5 cm / 5 3/8"
Blätter
blades
hojas
lames
lame
35 mm

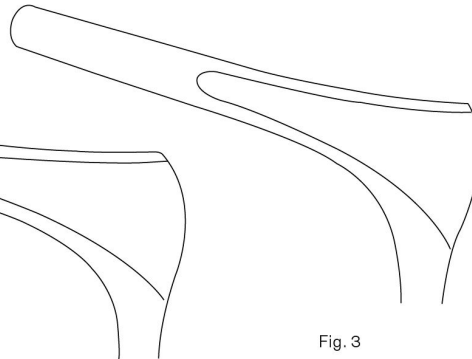

Fig. 2
B22-261-02
14 cm / 5 4/8"
Blätter
blades
hojas
lames
lame
50 mm

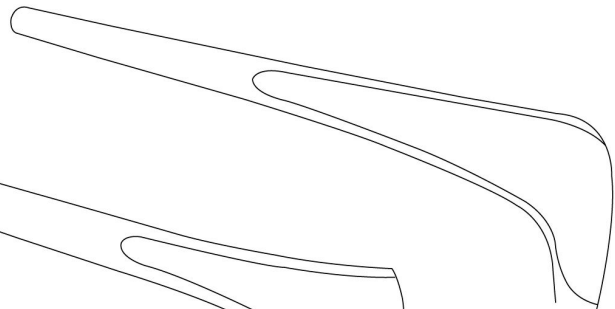

Fig. 3
B22-261-03
16 cm / 6 2/8"
Blätter
blades
hojas
lames
lame
75 mm

Fig. 4
B22-261-04
16 cm / 6 2/8"
Blätter
blades
hojas
lames
lame
85 mm



Nasal Specula

Nasenspekula
Especulos nasales
Spéculums nasaux
Specoli nasali

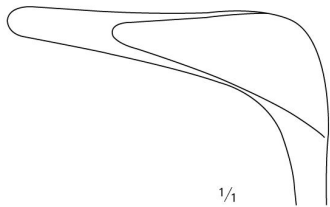

1/1

B22-262-45

14 cm / 5 4/8"

Blätter
blades
hojas
lames
lame
45 mm

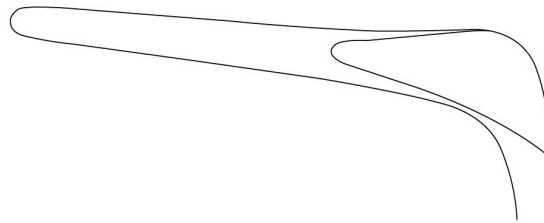

B22-262-75

15,5 cm / 6 1/8"

Blätter
blades
hojas
lames
lame
75 mm



1/2

Cottle

B22-262-45

B22-262-75

schwarz
black
negro
noir
nero



Polypus Snares

Polypenschnürer
Polipótomos
Serre-noeuds pour polypes
Serranodi per polipi

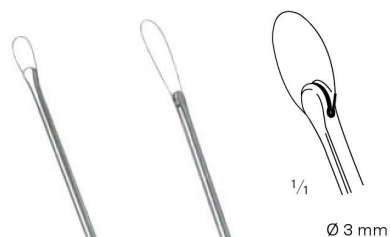
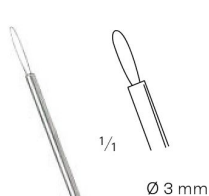

Krause

B22-263-26

26 cm / 10 3/8"

Schaft
shaft
vástago
tige
asta

Krause-Voss

B22-264-26

26 cm / 10 3/8"

Schaft
shaft
vástago
tige
asta

B22-265-30

B22-265-40

Schnürdraht
Snare Wire
Asa de alambre
Anse en fil d'acier
Filo per allacciare

Rolle mit 10 m
coil of 10 m
rollo de 10 m
en rouleaux de 10 m
rotolo di 10 m

B22-266-10

10,5 cm / 4"

Schnürdraht
Snare Wire
Asas de alambre
Anses en fil d'acier
Filo per allacciare
0,3 mm Ø

Bündel mit 12 Stück
bundle with 12 pieces
12 piezas atados
paquet de 12 pièces
confezione di 12 pezzi



no one does it BETTER



Cell: 0092 323 9300123

Tel: 0092 52 3563378

URL: <https://bona-dent.com>

Email: info@bona-dent.com

Email: bonadent.mfg@gmail.com

Address:

Kacha Shahab Pura Road

Jeewan Pura, Sialkot (51310)

Pakistan.

