

CH 06

Amalgam Instruments
Amalgaminstrumente
Instrumentos para amalgama
Instrumente à amalgame
Strumenti per amalgma

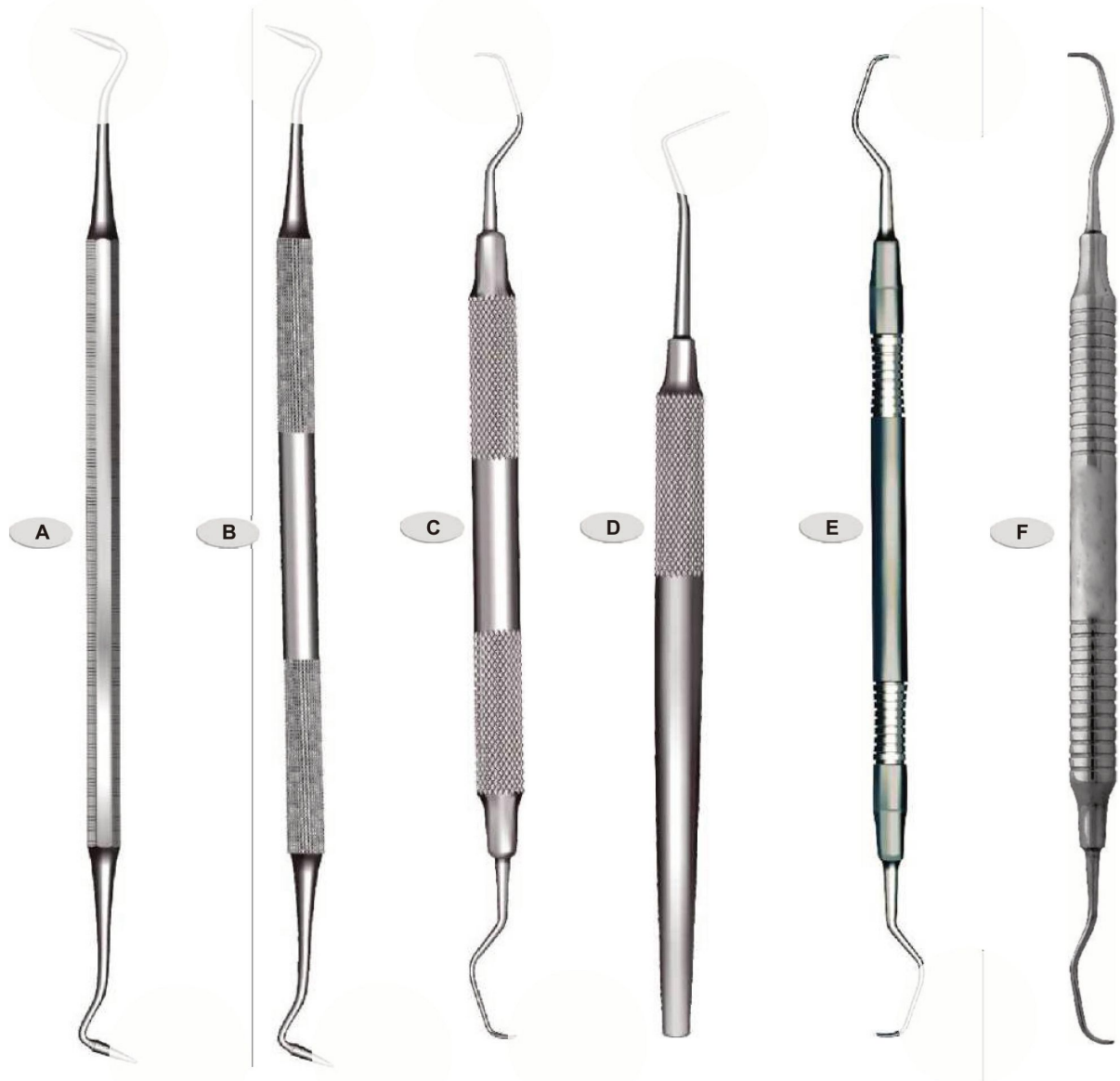

**Choice of Handles for Scalers, Amalgam Instruments,
Filling Instruments, Curettes, Probes, Knives, Explorers and Excavators**



If you wish to order a different type (**A, B, C, D, E and F**) of handle for a particular products, please mention **that** type with the code number of that product.

Example : B-06-1001C

If you wish to order a particular type (**A, B, C, D, E and F**) of handle with all instruments, please mention **that** type in your purchase order.

Example : Please use handle C for all Scalers.

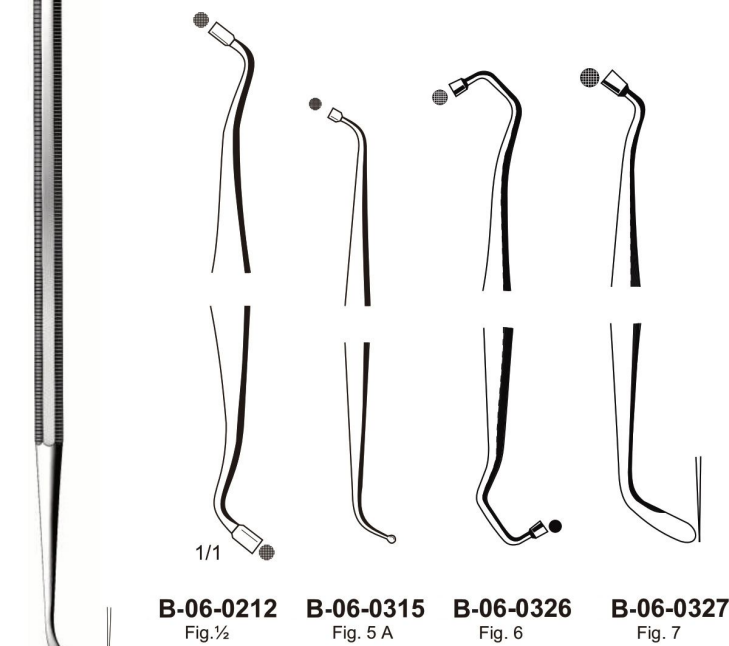
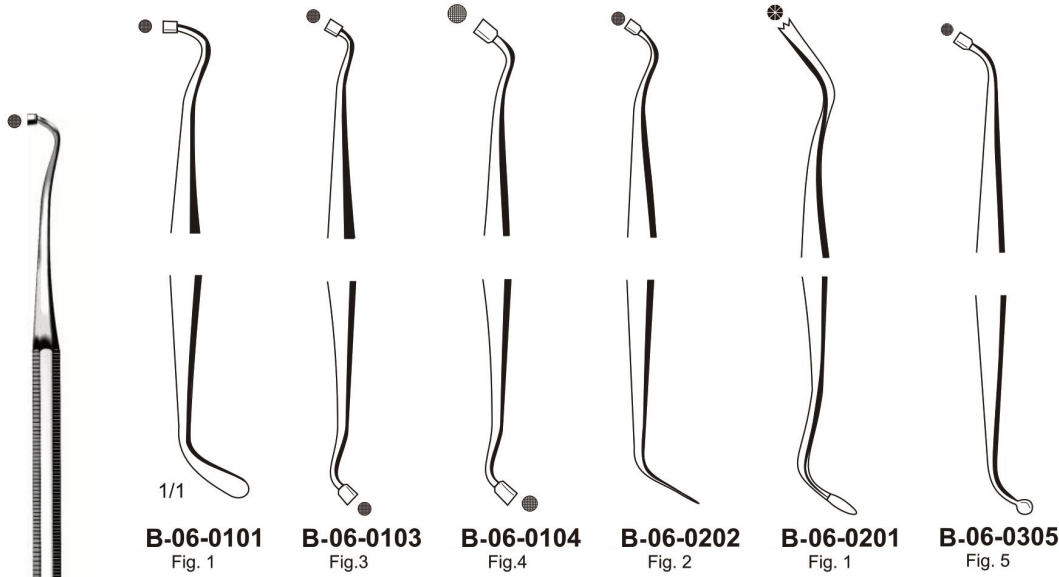

B-06-0101 - B-06-0315



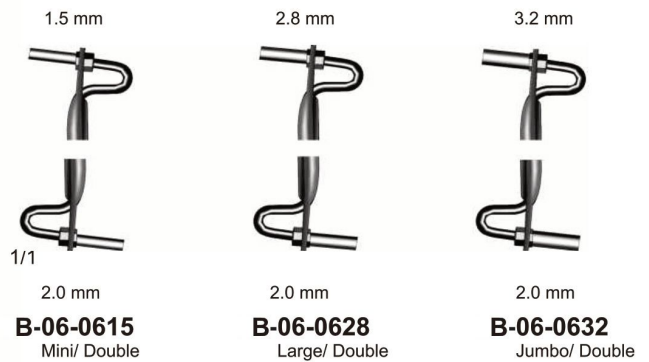
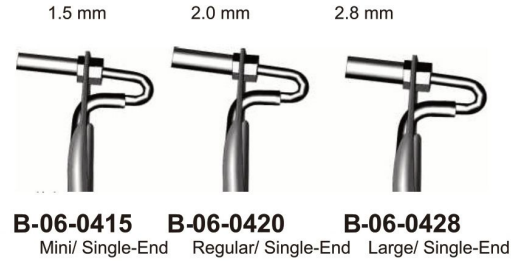

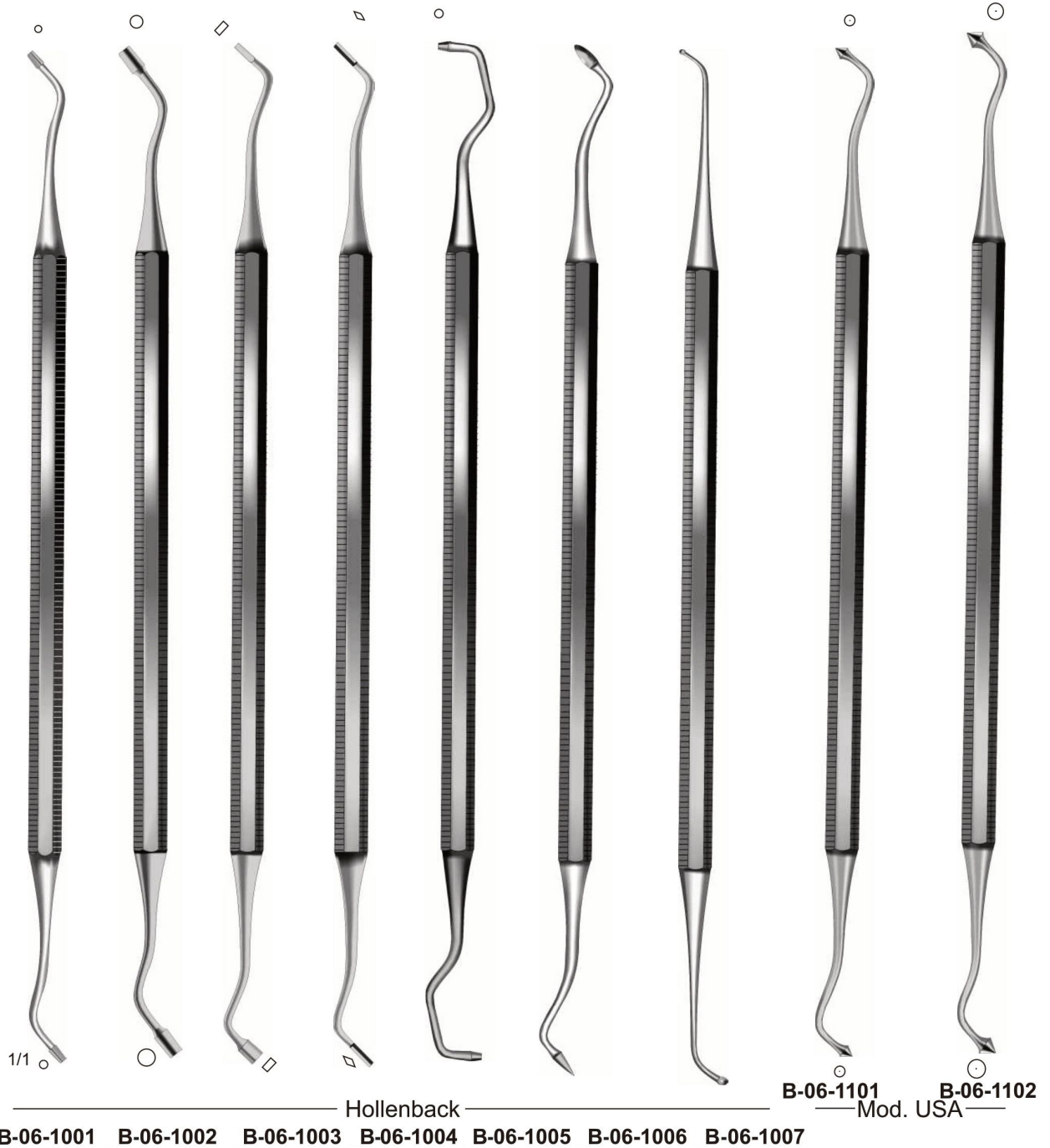

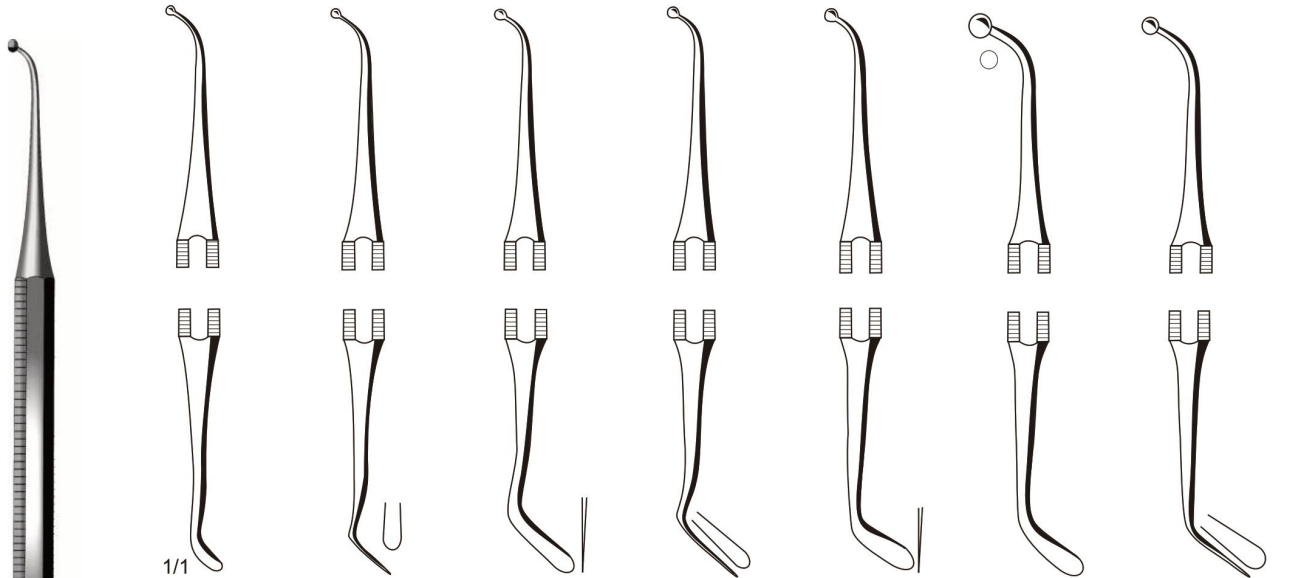

Mod. PHF

B-06-1201 Fig.1 **B-06-1202** Fig.2 **B-06-1303** Fig.3 **B-06-1403** Fig.3 A **B-06-1404** Fig.4 **B-06-1504** Fig.4 A **B-06-1544** Fig.4 R

B-06-1201 -
B-06-1544
16cm/6 1/4"

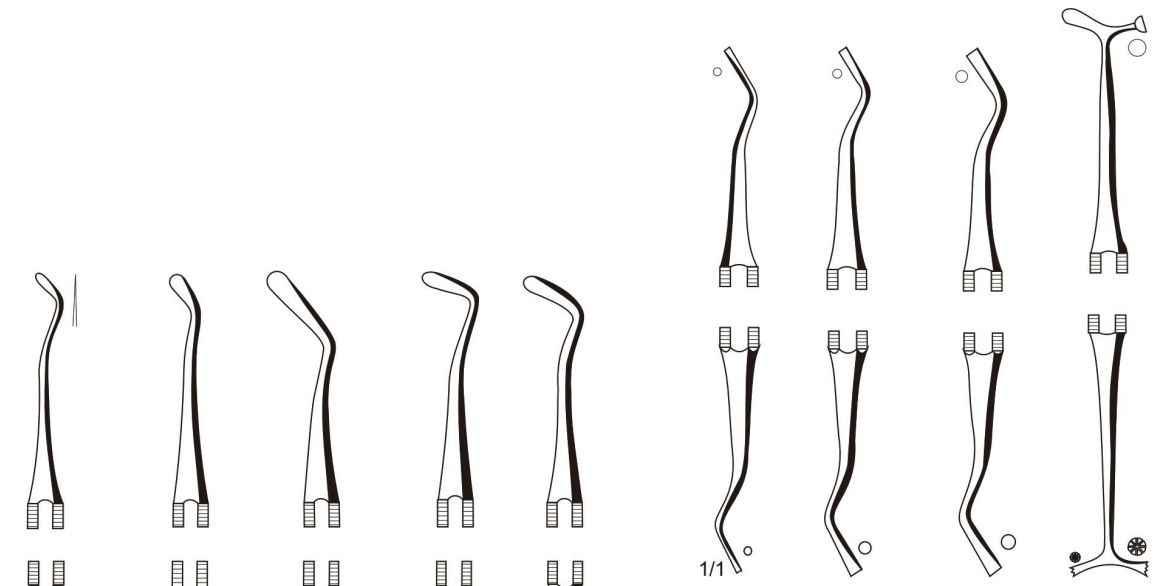

Williams

B-06-1700 Fig.0 **B-06-1701** Fig.1 **B-06-1702** Fig.2 **B-06-1703** Fig.3

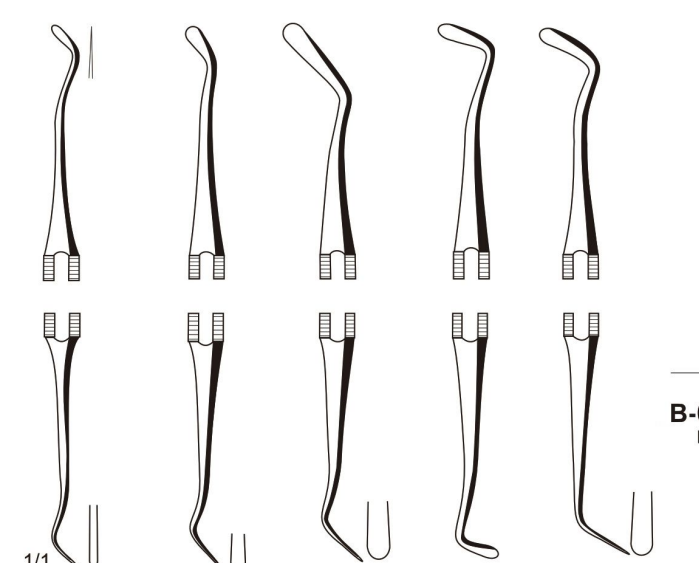

B-06-1600 Fig.0 **B-06-1601** Fig.1 **B-06-1602** Fig.2 **B-06-1604** Fig.4 **B-06-1606** Fig.6

Please see page 34 for different handle styles.



Bona-dent
Manufacturing Co.

Plastic Filling Instruments
Instrumente für plastische füllungen
Instrumentos para obturaciones plasticas
Instruments pour plombages plastiques
Strumenti per otturazioni in plastica



**B-06-1800 -
B-06-2205**

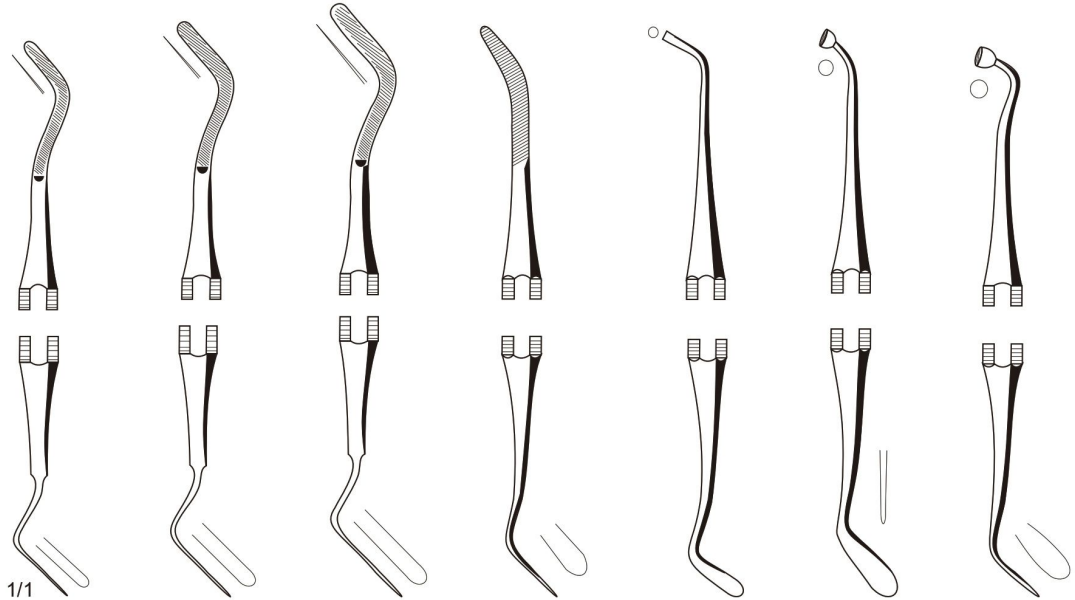

1/1
Heidemann White Woodson
B-06-1800 **B-06-1801** **B-06-1802** **B-06-1903** **B-06-1904** **B-06-1905** **B-06-1906**
Fig.0 Fig.1 Fig.2 Fig.1 Fig.3 Fig.2 Fig.3

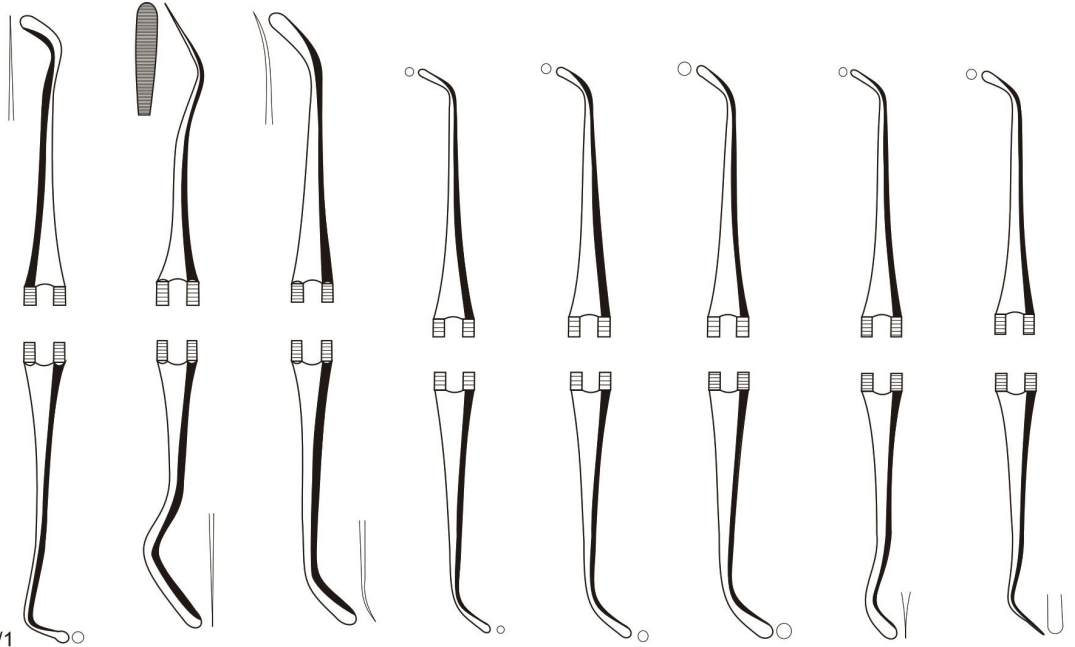

1/1
White Ash
B-06-2103 **B-06-2104** **B-06-2105** **B-06-2201** **B-06-2202** **B-06-2203** **B-06-2204** **B-06-2205**
Fig.3 Fig.4 Fig.5 Fig.1 Fig.2 Fig.3 Fig.4 Fig.5

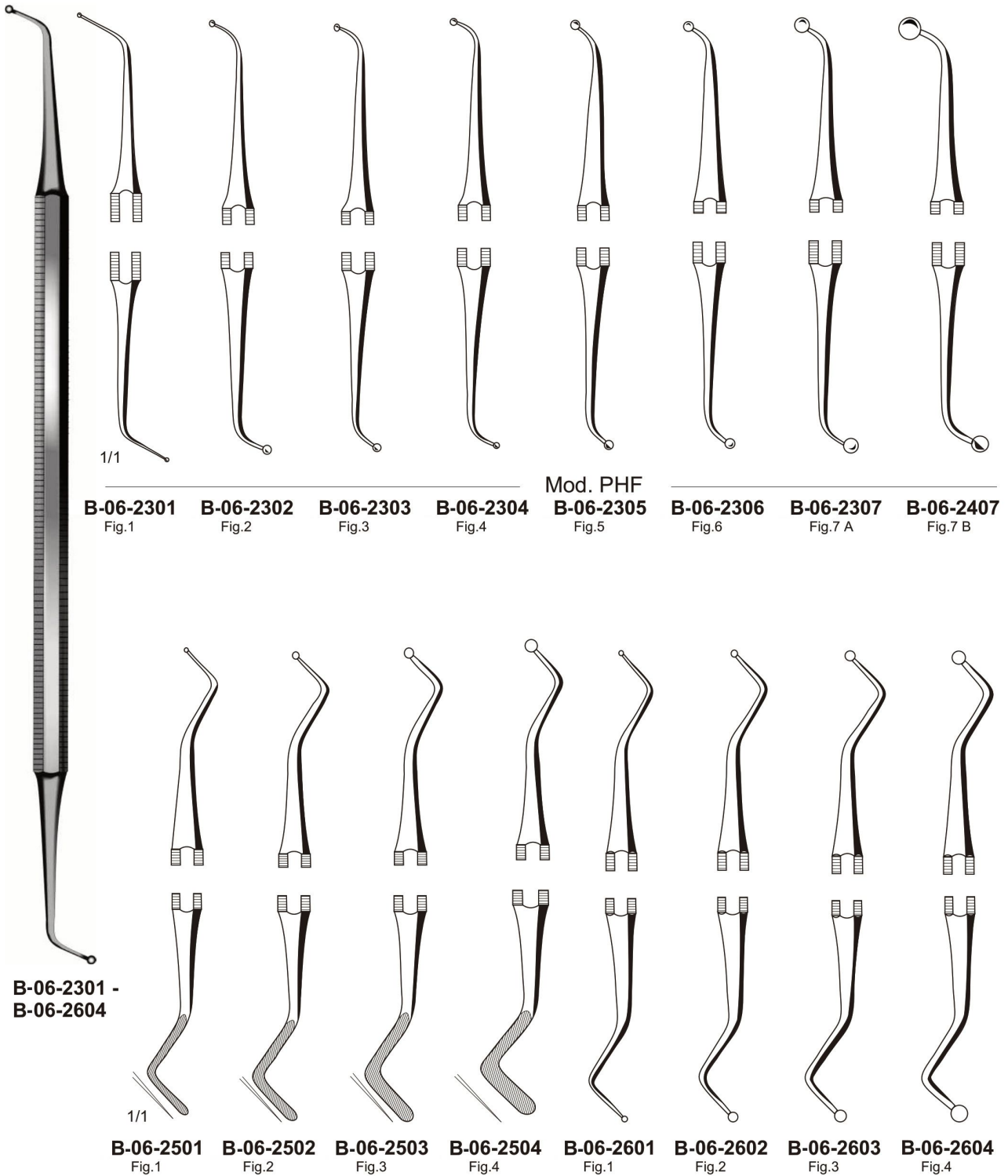

Please see page 34 for different handle styles.



Bonadent
Manufacturing Co.

Plastic Filling Instruments
Instrumente für plastische füllungen
Instrumentos para obturaciones plasticas
Instruments pour plombages plastiques
Strumenti per otturazioni in plastica

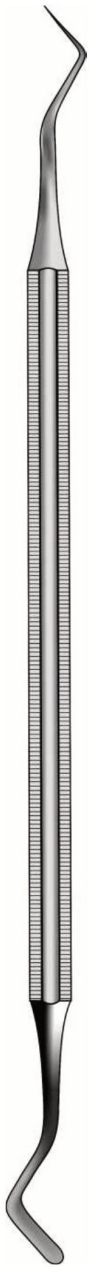

B-06-2713 - B-06-3037

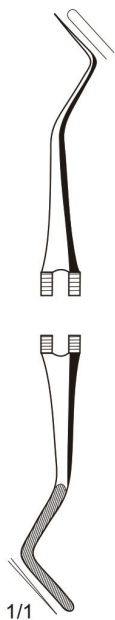

B-06-2713
Fig.13

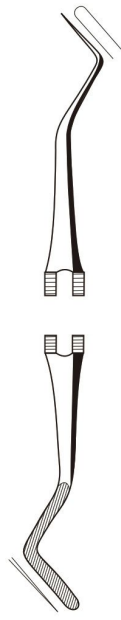

B-06-2714
Fig.14

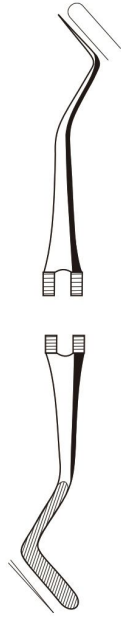

B-06-2715
Fig.15

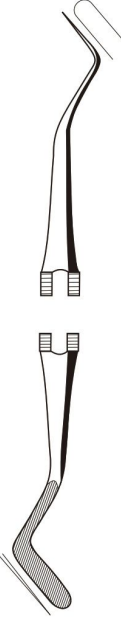

B-06-2716
Fig.16

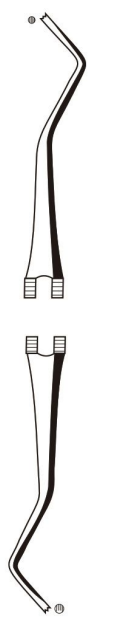

B-06-2826
Fig.26

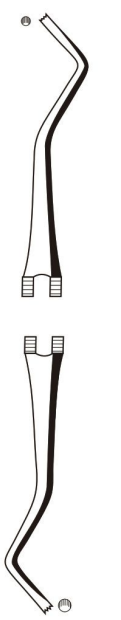

B-06-2827
Fig.27

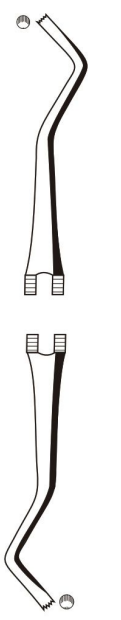

B-06-2828
Fig.28

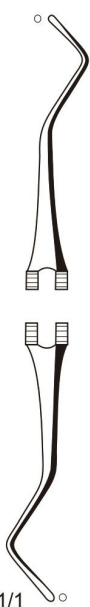

B-06-2917
Fig.17

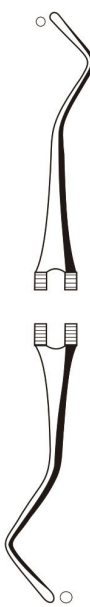

B-06-2918
Fig.18

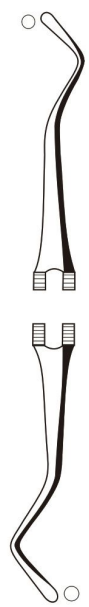

B-06-2919
Fig.19

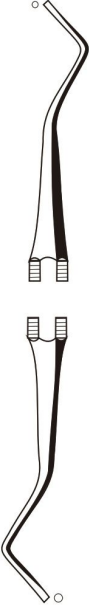

B-06-3035
Fig.35

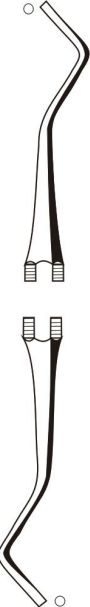

B-06-3036
Fig.36

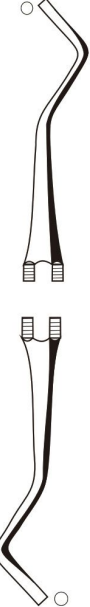

B-06-3037
Fig.37

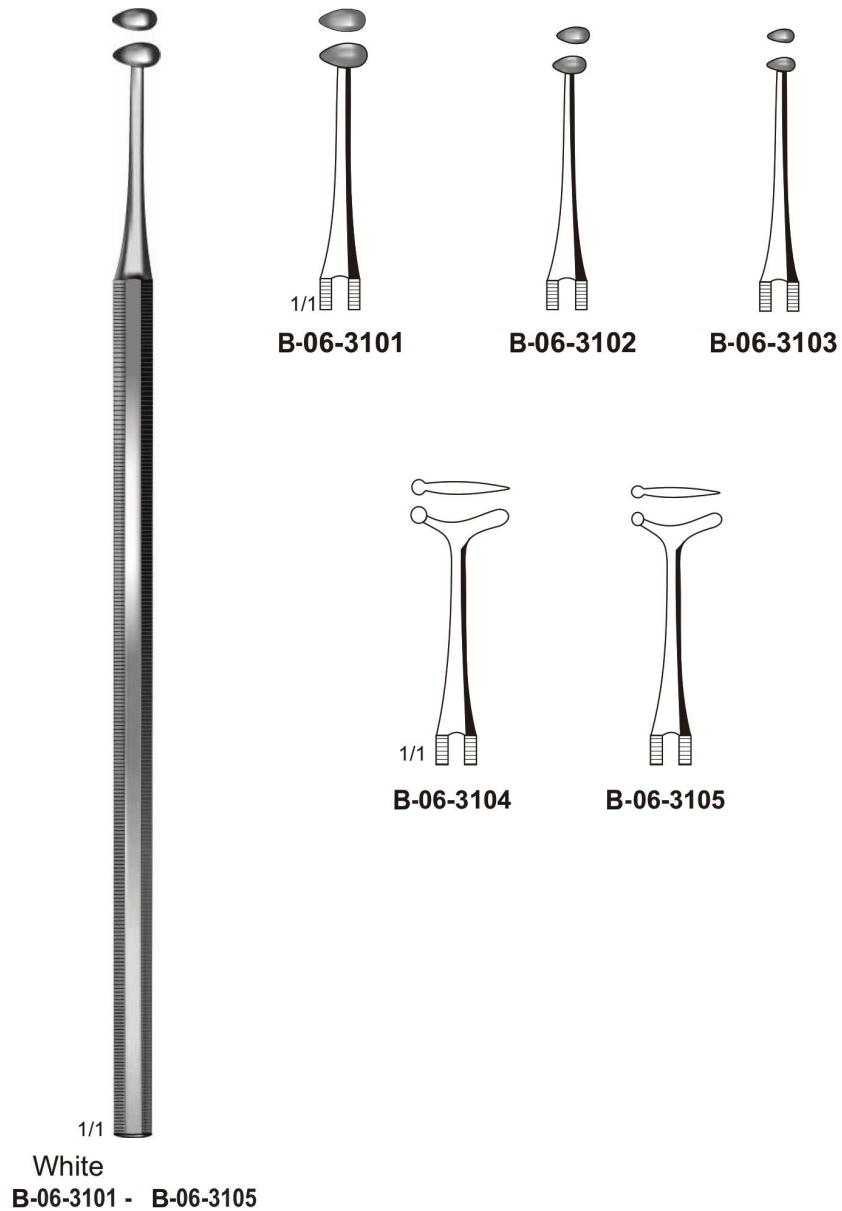

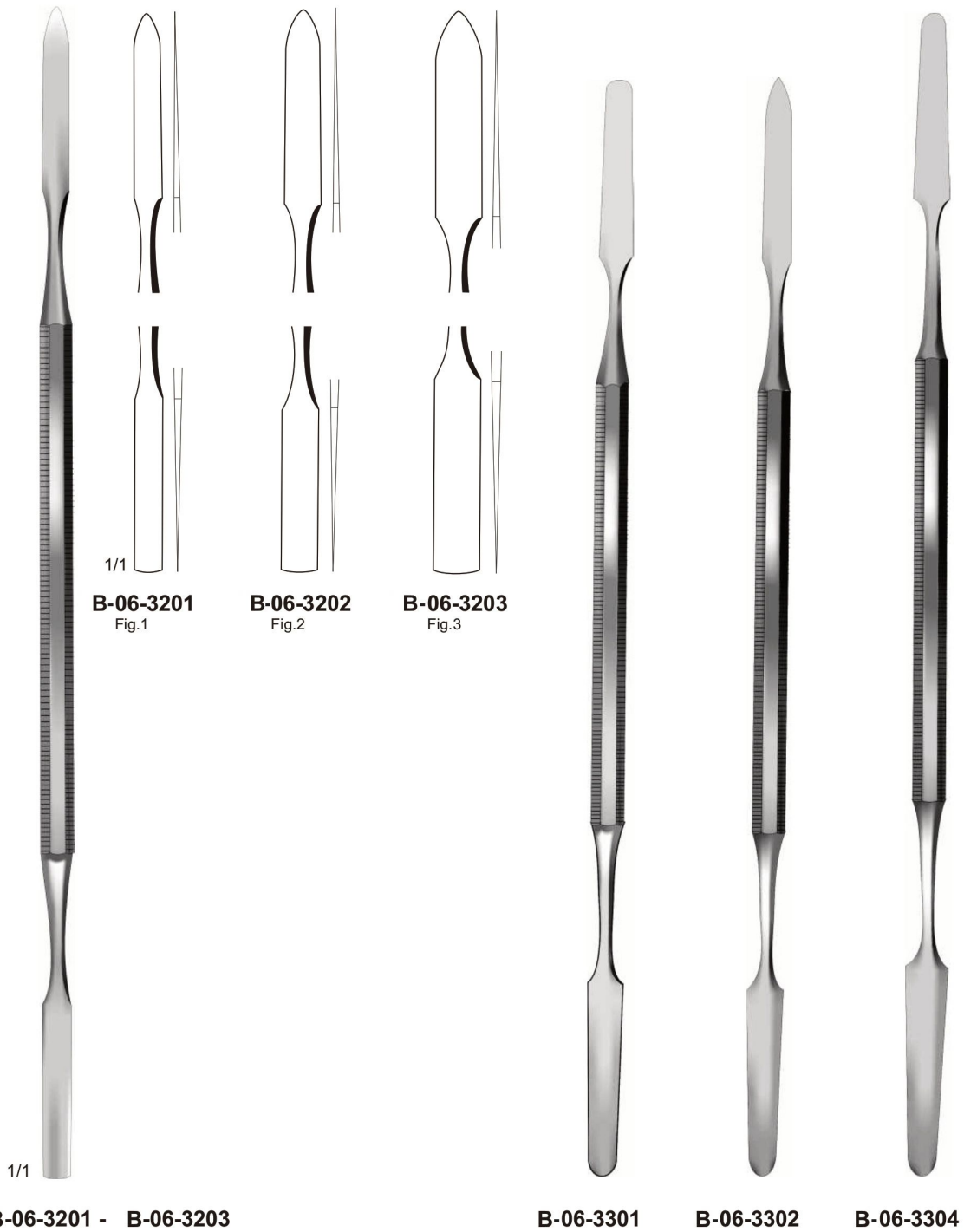



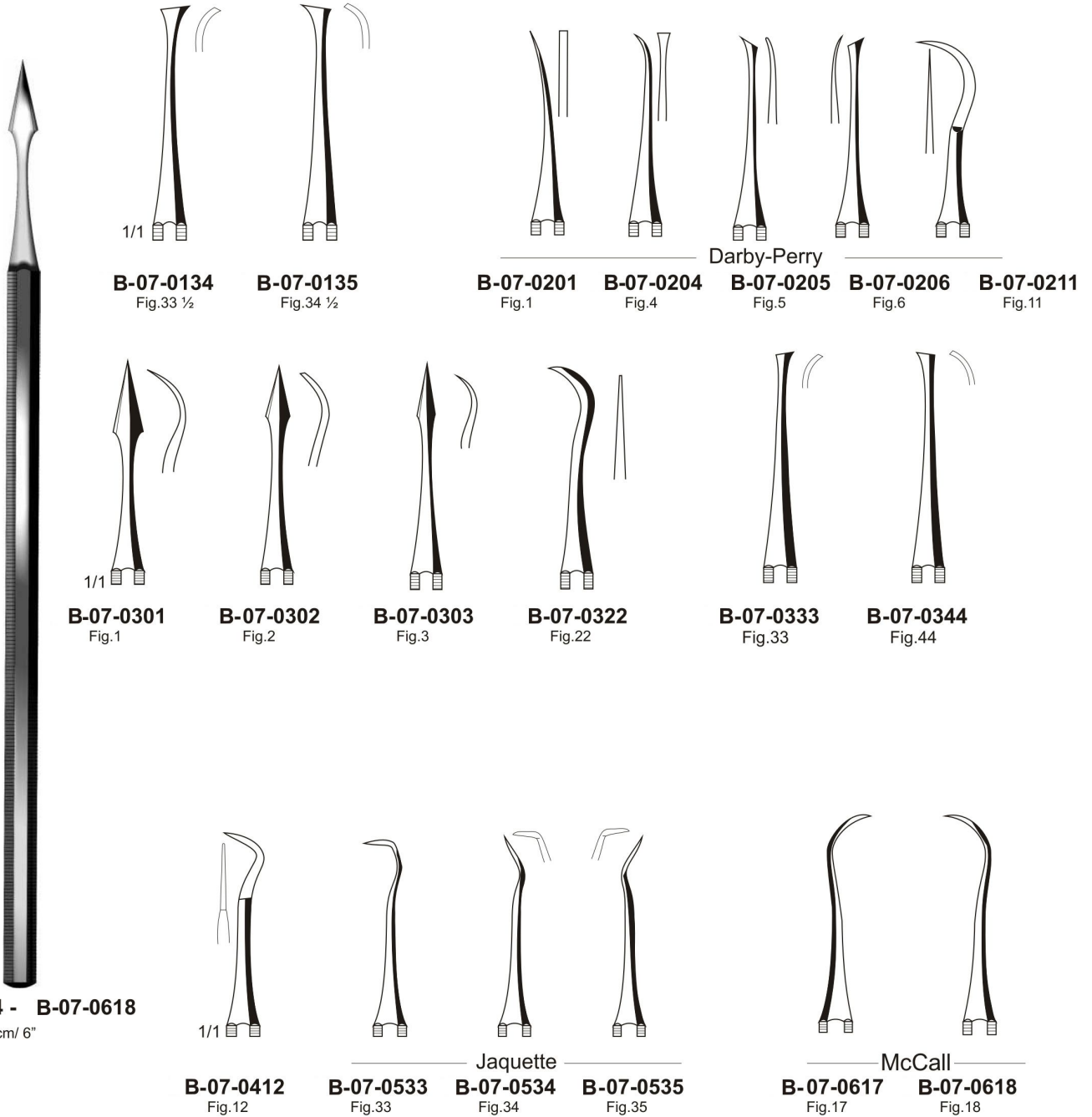

Please see page 34 for different handle styles.

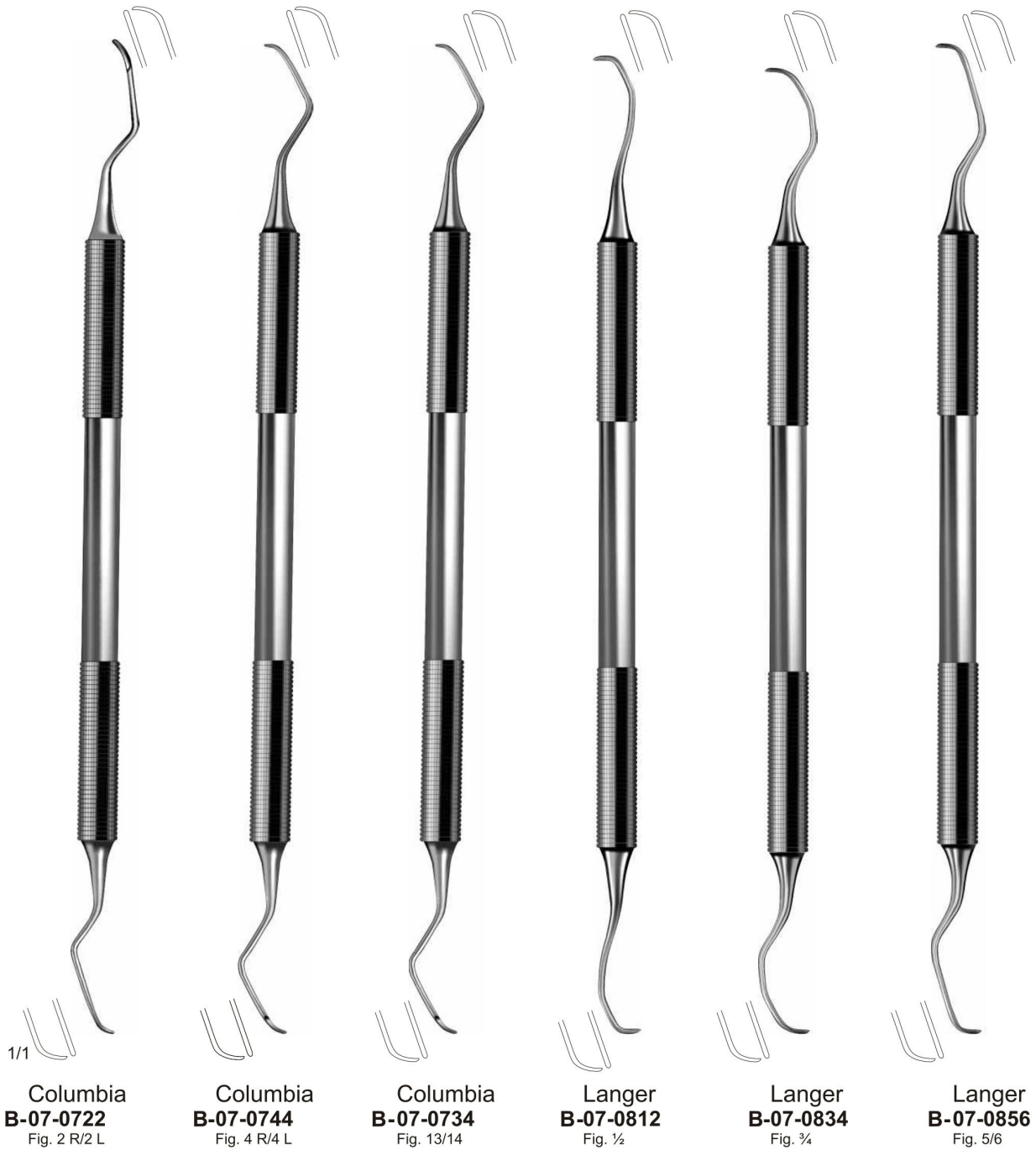

Columbia
B-07-0722
 Fig. 2 R/2 L

Columbia
B-07-0744
 Fig. 4 R/4 L

Columbia
B-07-0734
 Fig. 13/14

Langer
B-07-0812
 Fig. 1/2

Langer
B-07-0834
 Fig. 3/4

Langer
B-07-0856
 Fig. 5/6



Younger-Good
B-07-0978
 Fig. 7/8

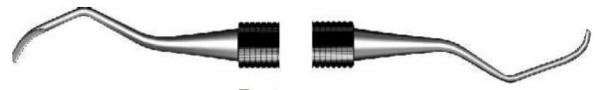

Bates
B-07-1334
 Fig. 135/145



Barnhart
B-07-1012
 Fig. ½



Rule
B-07-1434
 Fig. ¾

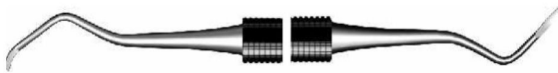

Barnhart
B-07-1056
 Fig. 5/6



B-07-1441
 Fig. 411/412



Indiana University (Anterior)
B-07-1134
 Fig. 13/14+

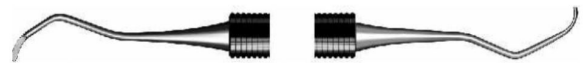

B-07-1541
 Fig. 413/414

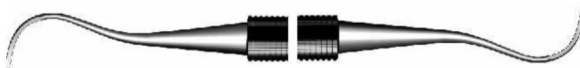

Indiana University (Posterior)
B-07-1178
 Fig. 17/18+



Mallery
B-07-1612
 Fig. ½

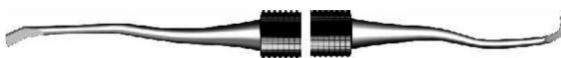

Bunting
B-07-1212
 Fig. ½+



Goldman
B-07-1632
 Fig. 31/32



Bunting
B-07-1256
 Fig. 5/6

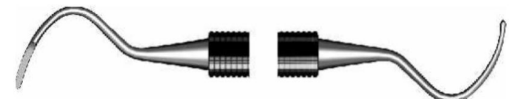

B-07-1711
 Fig. 1



Anterior
B-07-1812
 Fig. ½

Please see page 34 for different handle styles.